

2017



Product Catalogue

Camelion®

www.camelion.com

...for more energy



Camelion offers a wide range of
high quality products to give the consumer

More Energy Solutions

and extraordinary value for their electronic equipments.

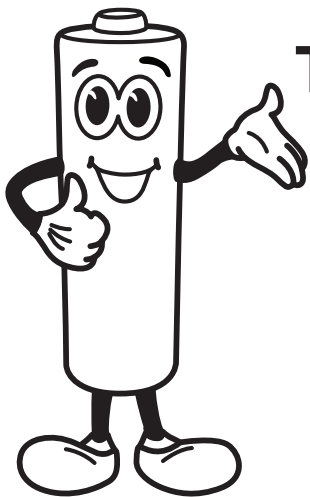

**Try us out
today!**

- **Primary Batteries**
- **Rechargeable Batteries and Chargers**
- **Flashlights and Lanterns**
- **Power Supplies**

When you need more energy solutions, try Camelion!

CONTENT

Primary Batteries

Lithium	6
9V Lithium	6
Digi Alkaline	7
Plus Alkaline	8
Super Heavy Duty (Blue)	14
Super Heavy Duty (Green)	15
Photo Lithium	18

Electronic Button Cells

Electronics Lithium	19
Electronics Alkaline	20
Remote Control Batteries	21
Electronics Silver Oxide	22
Zinc Air	22
Battery Accessoires	23
Battery Selection Chart	24

Rechargeable Batteries

AlwaysReady	26
Ni-MH	28

Battery Chargers

Ultra Fast Chargers

BC-0907	33
---------	----

Super Fast Chargers

BC-1007	34
BC-0903	35

Fast Chargers

BC-1002A	36
BC-1012	37

Overnight Chargers

BC-1001A	38
BC-0904S	39
BC-0901	40

Universal Chargers

CM9398GS	41
CM3298	42
LBC-312	43

Battery Charging Table	44
-------------------------------	-----------

Power Supplies

Power Banks

PS671, PS674, PS660	47
PS661, PS638, PS639	48

USB Power Adapters

AD568, AD569, AD570	49
---------------------	----

USB Car Chargers

DD801, DD802	50
DD812, DD823	51
Device Chart	52

Battery Powered Flashlights

TRAVLite™ Flashlights

LED Pocket Flashlight HP7011	54
LED Rubber Flashlight PT1L2D, PT1L2AA	54
LED Lantern SL1011	56

SuperBright™ Flashlights

Multi-head LED Classic FL6L2D	57
Multi-head LED Search Lamp FL-16LED, FL-9LED	58
Classic Flashlight FL1L2D, FL1L2C, FL1L2AA	60
Super Bright LED SL3013	62

Professional Products

Penlight DL2AAAS	64
----------------------------	----

Flashlight Replacement Bulbs

LED bulbs	65
-----------	----

CT-Series LED Flashlights

High grade aluminium flashlight with maximum illumination CT4002, CT4004, CT4005, CT4010	66
--	----

LED Lantern Solar Lantern, CT4008	68
---	----

3 Watt Headlight CT4007	68
-----------------------------------	----

Work Lights

SL5240N	70
---------	----

Multi Light 2 in 1 SL7280N	70
--------------------------------------	----

Inspection Light T11	72
--------------------------------	----

Domestic Lighting

Sensor Light SL7018	73
-------------------------------	----

Promotional

74

Primary Batteries

Lithium P⁷ Batteries



Camelion Lithium P7™ batteries offer a unique combination of lightness and high energy density. As Camelion's most powerful primary battery, the P7 batteries, offer unbeatable performance for your high drain devices such as digital cameras, music players and games. It can be stored up to 10 years.



FR6-BP2

1.5V AA



Packaging		
Blister	2 pcs/pack	Gross Weight: 9.3 kg
Inner Box	12 packs/box	Volume: 0.0251 cbm
Outer Carton	216 packs/carton	

Dimensions		
Blister (mm)	84(W) x 114(H) x 15(D)	
Inner Box (mm)	131(L) x 98(W) x 86(H)	
Outer Carton (cm)	41.5(L) x 27.5(W) x 22.0(H)	



FR03-BP2

1.5V AAA



Packaging		
Blister	2 pcs/pack	Gross Weight: 8.0 kg
Inner Box	12 packs/box	Volume: 0.0237 cbm
Outer Carton	288 packs/carton	

Dimensions		
Blister (mm)	84(W) x 114(H) x 11(D)	
Inner Box (mm)	119(L) x 75(W) x 86(H)	
Outer Carton (cm)	32.5(L) x 26.0(W) x 28.0(H)	

9V Lithium Battery

The new Lithium 9V Battery from Camelion is a high capacity battery designed to provide long lasting life and stable operating voltage.

- Up to 5x Longer Lasting*
- Low Self Discharge
- Anti leakage crimp design
- Temperature Range -20°C to +55°C
- Non-rechargeable
- 10 Year Shelf Life
- High And Stable Operating Voltage

*compare with alkaline batteries. Camelion 2010 Lab Tests.



ER9V-SP1

9V



Packaging		
Shrink	1 pcs/pack	Gross Weight: 14.5 kg
Inner Box	20 packs/box	Volume: 0.0083 cbm
Outer Carton	200 packs/carton	

Dimensions		
Shrink (mm)	25.5(W) x 48.5(H) x 17.5 (D)	
Inner Box (mm)	145(L) x 74(W) x 54(H)	
Outer Carton (cm)	39.0(L) x 17.5(W) x 13.5(H)	



ER9V-BP1

9V



Packaging		
Blister	1 pcs/pack	Gross Weight: 8.3 kg
Inner Box	12 packs/box	Volume: 0.0246 cbm
Outer Carton	192 packs/carton	

Dimensions		
Blister (mm)	84(W) x 114(H) x 18(D)	
Inner Box (mm)	123(L) x 117(W) x 86(H)	
Outer Carton (cm)	36.2(L) x 26.3(W) x 25.8(H)	

Digi Alkaline Batteries

Camelion Digi Alkaline batteries are the right solution for many electronic devices including digital cameras, music players, and boom boxes. Using a new technology they offer long lasting power for high drain devices.



LR20-BP2DG

1.5V D



Packaging		Gross Weight:
Blister	2 pcs/pack	15.0 kg
Inner Box	6 packs/box	Volume:
Outer Carton	48 packs/carton	0.0157 cbm

Dimensions

Blister (mm)	84(W) x 114(H) x 34(D)
Inner Box (mm)	160(L) x 110(W) x 92(H)
Outer Carton (cm)	33.5(L) x 19.5(W) x 24.0(H)



LR14-BP2DG

1.5V C



Packaging		Gross Weight:
Blister	2 pcs/pack	14.3 kg
Inner Box	6 packs/box	Volume:
Outer Carton	96 packs/carton	0.0227 cbm

Dimensions

Blister (mm)	84(W) x 114(H) x 27(D)
Inner Box (mm)	140(L) x 90(W) x 92(H)
Outer Carton (cm)	37.5(L) x 29.5(W) x 20.5(H)



LR6-BP4DG

1.5V AA



Packaging		Gross Weight:
Blister	4 pcs/pack	15.4 kg
Inner Box	12 packs/box	Volume:
Outer Carton	144 packs/carton	0.0166 cbm

Dimensions

Blister (mm)	84(W) x 114(H) x 15(D)
Inner Box (mm)	131(L) x 98(W) x 86(H)
Outer Carton (cm)	27.5(L) x 28.0(W) x 21.5(H)



LR6-BP2DG

1.5V AA



Packaging		Gross Weight:
Blister	2 pcs/pack	12.6 kg
Inner Box	12 packs/box	Volume:
Outer Carton	216 packs/carton	0.0251 cbm

Dimensions

Blister (mm)	84(W) x 114(H) x 15(D)
Inner Box (mm)	131(L) x 98(W) x 86(H)
Outer Carton (cm)	41.5(L) x 27.5(W) x 22.0(H)



LR03-BP4DG

1.5V AAA



Packaging		Gross Weight:
Blister	4 pcs/pack	15.9 kg
Inner Box	12 packs/box	Volume:
Outer Carton	288 packs/carton	0.0237 cbm

Dimensions

Blister (mm)	84(W) x 114(H) x 11(D)
Inner Box (mm)	119(L) x 75(W) x 86(H)
Outer Carton (cm)	32.5(L) x 26.0(W) x 28.0(H)



LR03-BP2DG

1.5V AAA



Packaging		Gross Weight:
Blister	2 pcs/pack	9.1 kg
Inner Box	12 packs/box	Volume:
Outer Carton	288 packs/carton	0.0237 cbm

Dimensions

Blister (mm)	84(W) x 114(H) x 11(D)
Inner Box (mm)	119(L) x 75(W) x 86(H)
Outer Carton (cm)	32.5(L) x 26.0(W) x 28.0(H)



6LR61-BP1DG

9V



Packaging		Gross Weight:
Blister	1 pcs/pack	11.2 kg
Inner Box	12 packs/box	Volume:
Outer Carton	192 packs/carton	0.0246 cbm

Dimensions

Blister (mm)	84(W) x 114(H) x 18(D)
Inner Box (mm)	123(L) x 117(W) x 86(H)
Outer Carton (cm)	36.2(L) x 26.3(W) x 25.8(H)

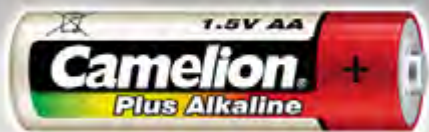

Plus Alkaline Batteries

Camelion Plus Alkaline batteries offer reliable power for high drain devices. They deliver stable and long lasting current couple to a long shelf life to support high drain devices such as CD players, toys, PDAs, and electronic games.



LR20-BP2
1.5V D
 4 260033 150004

Packaging
 Blister 2 pcs/pack
 Inner Box 6 packs/box
 Outer Carton 48 packs/carton

Gross Weight: 15.0 kg
Volume: 0.0157 cbm

Dimensions
 Blister (mm) 84(W) x 114(H) x 34(D)
 Inner Box (mm) 160(L) x 110(W) x 92(H)
 Outer Carton (cm) 33.5(L) x 19.5(W) x 24.0(H)



LR14-BP2
1.5V C
 4 260033 150011

Packaging
 Blister 2 pcs/pack
 Inner Box 6 packs/box
 Outer Carton 96 packs/carton

Gross Weight: 15.6 kg
Volume: 0.0227 cbm

Dimensions
 Blister (mm) 84(W) x 114(H) x 27(D)
 Inner Box (mm) 140(L) x 90(W) x 92(H)
 Outer Carton (cm) 37.5(L) x 29.5(W) x 20.5(H)



LR6-BP4
1.5V AA
 4 260033 150028

Packaging
 Blister 4 pcs/pack
 Inner Box 12 packs/box
 Outer Carton 144 packs/carton

Gross Weight: 15.5 kg
Volume: 0.0166 cbm

Dimensions
 Blister (mm) 84(W) x 114(H) x 15(D)
 Inner Box (mm) 131(L) x 98(W) x 86(H)
 Outer Carton (cm) 27.5(L) x 28.0(W) x 21.5(H)



LR6-BP2
1.5V AA
 4 260033 150035

Packaging
 Blister 2 pcs/pack
 Inner Box 12 packs/box
 Outer Carton 216 packs/carton

Gross Weight: 12.6 kg
Volume: 0.0251 cbm

Dimensions
 Blister (mm) 84(W) x 114(H) x 15(D)
 Inner Box (mm) 131(L) x 98(W) x 86(H)
 Outer Carton (cm) 41.5(L) x 27.5(W) x 22.0(H)



4+4LR6
1.5V AA
 4 260216 451096

Packaging
 Blister 8 pcs/pack
 Inner Box 12 packs/box
 Outer Carton 72 packs/carton

Gross Weight: 15.5 kg
Volume: 0.0199 cbm

Dimensions
 Blister (mm) 168(W) x 114(H) x 15(D)
 Inner Box (mm) 175(L) x 140(W) x 10.8(H)
 Outer Carton (cm) 43.5(L) x 19.0(W) x 24.0(H)



LR6-HP12
1.5V AA
 4 260033 150424

Packaging
 Blister 12 pcs/pack
 Outer Carton 48 packs/carton

Gross Weight: 14.1 kg
Volume: 0.0098 cbm

Dimensions
 Blister (mm) 170(W) x 99(H) x 15(D)
 Outer Carton (cm) 35.5(L) x 22.0(W) x 12.5(H)



LR6-BP10
1.5V AA
 4 260033 150097

Packaging
 Blister 10 pcs/pack
 Inner Box 12 packs/box
 Outer Carton 72 packs/carton

Gross Weight: 18.8 kg
Volume: 0.0239 cbm

Dimensions
 Blister (mm) 84(W) x 190(H) x 15(D)
 Inner Box (mm) 315(L) x 104(W) x 90(H)
 Outer Carton (cm) 33.0(L) x 31.5(W) x 23.0(H)



LR03-BP2
1.5V AAA
 4 260033 150059

Packaging
 Blister 2 pcs/pack
 Inner Box 12 packs/box
 Outer Carton 288 packs/carton

Gross Weight: 9.1 kg
Volume: 0.0237 cbm

Dimensions
 Blister (mm) 84(W) x 114(H) x 11(D)
 Inner Box (mm) 119(L) x 75(W) x 86(H)
 Outer Carton (cm) 32.5(L) x 26.0(W) x 28.0(H)



LR03-BP4
1.5V AAA
 4 260033 150042

Packaging		
Blister	4 pcs/pack	Gross Weight: 8.3 kg
Inner Box	12 packs/box	Volume: 0.0120 cbm
Outer Carton	144 packs/carton	

Dimensions

Blister (mm)	84(W) x 114(H) x 11(D)
Inner Box (mm)	119(L) x 75(W) x 86(H)
Outer Carton (cm)	27.5(L) x 25.5(W) x 17.0(H)



4+4LR03
1.5V AAA
 4 260216 4451102

Packaging		
Blister	8 pcs/pack	Gross Weight: 8.9 kg
Inner Box	12 packs/box	Volume: 0.0150 cbm
Outer Carton	72 packs/carton	

Dimensions

Blister (mm)	168(W) x 114(H) x 11(D)
Inner Box (mm)	175(L) x 130(W) x 85(H)
Outer Carton (cm)	41.5(L) x 19.0(W) x 19.0(H)



LR03-BP10
1.5V AAA
 4 260033 150103

Packaging		
Blister	10 pcs/pack	Gross Weight: 9.4 kg
Inner Box	12 packs/box	Volume: 0.0152 cbm
Outer Carton	72 packs/carton	

Dimensions

Blister (mm)	84(W) x 165(H) x 11(D)
Inner Box (mm)	243(L) x 85(W) x 90(H)
Outer Carton (cm)	30.0(L) x 26.0(W) x 19.5(H)



6LR61-BP1
9V
 4 260033 150066

Packaging		
Blister	1 pcs/pack	Gross Weight: 11.2 kg
Inner Box	12 packs/box	Volume: 0.0246 cbm
Outer Carton	192 packs/carton	

Dimensions

Blister (mm)	84(W) x 114(H) x 18(D)
Inner Box (mm)	123(L) x 117(W) x 86(H)
Outer Carton (cm)	36.2(L) x 26.3(W) x 25.8(H)



LR1-BP2
1.5V N
 4 260033 150080

Packaging		
Blister	2 pcs/pack	Gross Weight: 6.3 kg
Inner Box	6 packs/box	Volume: 0.0181 cbm
Outer Carton	192 packs/carton	

Dimensions

Blister (mm)	84(W) x 114(H) x 12(D)
Inner Box (mm)	116(L) x 45(W) x 86(H)
Outer Carton (cm)	36.2(L) x 25.0(W) x 20.0(H)



LR1-BP5
1.5V N
 4 260216 455780

Packaging		
Blister	5 pcs/pack	Gross Weight: 10.8 kg
Inner Box	12 packs/box	Volume: 0.0150 cbm
Outer Carton	192 packs/carton	

Dimensions

Blister (mm)	50(W) x 160(H) x (D)
Inner Box (mm)	170(L) x 78(W) x 52(H)
Outer Carton (cm)	33.5(L) x 19.0(W) x 23.5(H)



LR61-BP2
1.5V AAAA
 4 260033 150295

Packaging		
Blister	2 pcs/pack	Gross Weight: 6.2 kg
Inner Box	12 packs/box	Volume: 0.0251 cbm
Outer Carton	288 packs/carton	

Dimensions

Blister (mm)	84(W) x 114(H) x 11(D)
Inner Box (mm)	128(L) x 75(W) x 86(H)
Outer Carton (cm)	32.5(L) x 27.6(W) x 28.0(H)



3LR12-BP1
4.5V
 4 260033 150073

Packaging		
Blister	1 pcs/pack	Gross Weight: 16.9 kg
Inner Box	6 packs/box	Volume: 0.0295 cbm
Outer Carton	144 packs/carton	

Dimensions

Blister (mm)	84(W) x 114(H) x 23(D)
Inner Box (mm)	160(L) x 75(W) x 86(H)
Outer Carton (cm)	36.0(L) x 33.5(W) x 24.5(H)



LR6 bulk
1.5V AA

Packaging		
Inner Box	60 pcs/box	Gross Weight: 17.8 kg
Outer Carton	720 pcs/carton	Volume: 0.0096 cbm

Dimensions

Single (mm)	14(W) x 50(H) x 14(D)
Inner Box (mm)	174(L) x 72(W) x 50(H)
Outer Carton (cm)	23.5(L) x 21.5(W) x 19.0(H)



LR6-SP4
1.5V AA
 4 260033 150325

Packaging		
Shrink	4 pcs/pack	Gross Weight: 17.8 kg
Inner Box	15 packs/box	Volume: 0.0096 cbm
Outer Carton	180 packs/carton	

Dimensions

Shrink (mm)	56(W) x 50(H) x 14(D)
Inner Box (mm)	174(L) x 72(W) x 50(H)
Outer Carton (cm)	23.5(L) x 21.5(W) x 19.0(H)





LR6-SP2

1.5V AA



Packaging		
Shrink	2 pcs/pack	Gross Weight: 17.9 kg
Inner Box	20 packs/box	Volume: 0.0100 cbm
Outer Carton	360 packs/carton	

Dimensions

Shrink (mm)	28(W) x 50(H) x 14(D)
Inner Box (mm)	113(L) x 72(W) x 50(H)
Outer Carton (cm)	31.5(L) x 23.5(W) x 13.5(H)



LR03 bulk

1.5V AAA

Packaging		
Inner Box	60 pcs/box	Gross Weight: 14.7 kg
Outer Carton	1200 pcs/carton	Volume: 0.0084 cbm
Dimensions		

Single (mm)	10(W) x 44.5(H) x 10(D)
Inner Box (mm)	83(L) x 52(W) x 45(H)
Outer Carton (cm)	29.0(L) x 19.0(W) x 15.0(H)



LR03-SP2

1.5V AAA



Packaging		
Shrink	2 pcs/pack	Gross Weight: 14.8 kg
Inner Box	20 packs/box	Volume: 0.0083 cbm
Outer Carton	600 packs/carton	

Dimensions

Shrink (mm)	20(W) x 44.5(H) x 10(D)
Inner Box (mm)	83(L) x 52(W) x 45(H)
Outer Carton (cm)	29.0(L) x 19.0(W) x 15.0(H)



LR03-SP4

1.5V AAA



Packaging		
Shrink	4 pcs/pack	Gross Weight: 14.7 kg
Inner Box	15 packs/box	Volume: 0.0084 cbm
Outer Carton	300 packs/carton	

Dimensions

Shrink (mm)	40(W) x 44.5(H) x 10(D)
Inner Box (mm)	125(L) x 52(W) x 45(H)
Outer Carton (cm)	29.0(L) x 20.0(W) x 14.5(H)



LR14-SP2

1.5V C



Packaging		
Shrink	2 pcs/pack	Gross Weight: 16.6 kg
Inner Box	6 packs/box	Volume: 0.0123 cbm
Outer Carton	120 packs/carton	

Dimensions

Shrink (mm)	52(W) x 50(H) x 26(D)
Inner Box (mm)	107(L) x 81(W) x 56(H)
Outer Carton (cm)	29.5(L) x 22.5(W) x 18.5(H)



LR20-SP2

1.5V D



Packaging		
Shrink	2 pcs/pack	Gross Weight: 16.7 kg
Inner Box	6 packs/box	Volume: 0.0122 cbm
Outer Carton	60 packs/carton	

Dimensions

Shrink (mm)	66(W) x 61(H) x 33(D)
Inner Box (mm)	137(L) x 103(W) x 68(H)
Outer Carton (cm)	35.5(L) x 15.0(W) x 23.0(H)



6LR61-SP1

9V



Packaging		
Shrink	1 pcs/pack	Gross Weight: 11.4 kg
Inner Box	12 packs/box	Volume: 0.0083 cbm
Outer Carton	240 packs/carton	

Dimensions

Shrink (mm)	25.5(W) x 48.5(H) x 17.5 (D)
Inner Box (mm)	105(L) x 52(W) x 50(H)
Outer Carton (cm)	29.0(L) x 23.0(W) x 12.5(H)



3LR12-SP1

4.5V



Packaging		
Shrink	1 pcs/pack	Gross Weight: 16.6 kg
Inner Box	12 packs/box	Volume: 0.0233 cbm
Outer Carton	192 packs/carton	

Dimensions

Shrink (mm)	62(W) x 65.5 (H) x 22 (D)
Inner Box (mm)	188(L) x 90(W) x 65(H)
Outer Carton (cm)	38.5(L) x 20.5(W) x 29.5(H)



LR6-PB24

1.5V AA



Packaging		
Box	24 pcs/pack	Gross Weight: 18.3 kg
Outer Carton	30 packs/carton	Volume: 0.0178 cbm

Dimensions

Plastic box (mm)	98(L) x 75(W) x 50(H)
Outer Carton (cm)	42.5(L) x 22(W) x 19(H)



LR03-PB24

1.5V AAA



Packaging		
Box	24 pcs/pack	Gross Weight: 9.0 kg
Outer Carton	30 packs/carton	Volume: 0.0107 cbm

Dimensions

Plastic box (mm)	80(L) x 60(W) x 45(H)
Outer Carton (cm)	34.5(L) x 18.5(W) x 17.0(H)



LR6-PB20

1.5V AA



Packaging
Box 20 pcs/pack
Outer Carton 30 packs/carton
Gross Weight: 15.0 kg
Volume: 0.0150 cbm

Dimensions
Plastic box (mm) 82(L) x 75(W) x 50(H)
Outer Carton (cm) 43.0(L) x 19.2(W) x 19.0(H)



LR03-PB20

1.5V AAA



Packaging
Box 20 pcs/pack
Outer Carton 30 packs/carton
Gross Weight: 7.8 kg
Volume: 0.0074 cbm

Dimensions
Plastic box (mm) 66(L) x 64(W) x 44(H)
Outer Carton (cm) 34.5(L) x 15.5(W) x 17.5(H)



6LR61-PB6

9V



Packaging
Box 6 pcs/pack
Inner Box 6 packs/box
Outer Carton 24 packs/carton
Gross Weight: 7.8 kg
Volume: 0.0105 cbm

Dimensions
Plastic box (mm) 71(L) x 68(W) x 49 (H)
Inner Box (mm) 210(L) x 148(W) x 60(H)
Outer Carton (cm) 31.0(L) x 22.5(W) x 15.0(H)



LR03-PBH24

1.5V AAA



Packaging
Box 24 pcs/pack
Inner Box 12 packs/box
Outer Carton 24 packs/carton
Gross Weight: 8.8 kg
Volume: 0.0067 cbm

Dimensions
Plastic box (mm) 96(L) x 70(W) x 26(H)
Inner Box (mm) 21.5(L) x 200(W) x 55(H)
Outer Carton (cm) 23.0(L) x 21.5(W) x 13.5(H)



LR6-PBH24

1.5V AA



Packaging
Box 24 pcs/pack
Inner Box 12 packs/box
Outer Carton 24 packs/carton
Gross Weight: 16.3 kg
Volume: 0.0116 cbm

Dimensions
Plastic box (mm) 108(L) x 92(W) x 32(H)
Inner Box (mm) 285(L) x 220(W) x 70(H)
Outer Carton (cm) 30.0(L) x 23.5(W) x 16.5(H)



LR03-PBH12

1.5V AAA



Packaging
Box 12 pcs/pack
Inner Box 24 packs/box
Outer Carton 48 packs/carton
Gross Weight: 7.5 kg
Volume: 0.0069 cbm

Dimensions
Plastic box (mm) 49(L) x 72(W) x 26(H)
Inner Box (mm) 150(L) x 150(W) x 110(H)
Outer Carton (cm) 32.0(L) x 16.5(W) x 13.0(H)



LR6-PBH12

1.5V AA



Packaging
Box 12 pcs/pack
Inner Box 24 packs/box
Outer Carton 48 packs/carton
Gross Weight: 15.2 kg
Volume: 0.0127 cbm

Dimensions
Plastic box (mm) 55(L) x 95(W) x 34(H)
Inner Box (mm) 195(L) x 170(W) x 142(H)
Outer Carton (cm) 36.5(L) x 21.0(W) x 16.5(H)



CM-FA-01



Packaging 10 x LR6 + 8 x LR03+
 2 x 6LF22 + 4xC Size Adaptors+
 4 x D Size Adaptors+BT-0503
Outer Carton 10 boxes/carton
Gross Weight: 8.0 kg
Volume: 0.0195 cbm

Dimensions
Plastic box (mm) 255(L) x 173(W) x 37(H)
Outer Carton (cm) 35.5(L) x 20.0(W) x 27.5(H)



Shrink Wrap Packaging and Display Boxes

Handy Packaging!

Our shrink wrap packaging and display boxes help keep your batteries where you need them, with minimum fuss.

- Convenient & Easy to open
- Self-standing, sturdy display boxes
- Many sizes and shapes available
- Securely hold several batteries
- Professional, branded card inserts and designs for effective messaging



LR6-SP10-DA

1.5V AA



Packaging		Gross Weight:
Blister	10 pcs/pack	14.0 kg
Inner Box	24 packs/box	Volume:
Outer Carton	2 boxes/carton	0.0087 cbm
Dimensions		
Inner Box (mm)	150(L) x 190(W) x 108(H)	
Outer Carton (cm)	32.0(L) x 20.5(W) x 12.5(H)	



LR03-SP10-DA

1.5V AAA



Packaging		Gross Weight:
Blister	10 pcs/pack	12.0 kg
Inner Box	20 packs/box	Volume:
Outer Carton	4 boxes/carton	0.0075 cbm
Dimensions		
Inner Box (mm)	110(L) x 120(W) x 96(H)	
Outer Carton (cm)	26.0(L) x 24.0(W) x 11.0(H)	

Limited edition

Value pack for limited campaign



8+4LR6

1.5V AA



Packaging		Gross Weight:
Blister	6 pcs/pack	15.0 kg
Inner Box	12 packs/box	Volume:
Outer Carton	48 packs/carton	0.0154 cbm
Dimensions		
Blister (mm)	140(W) x 114(H) x 15(D)	
Inner Box (mm)	131(L) x 98(W) x 150(H)	
Outer Carton (cm)	33.0(L) x 29.0(W) x 16.0(H)	



8+4LR03

1.5V AAA



Packaging		Gross Weight:
Blister	6 pcs/pack	11.2 kg
Inner Box	12 packs/box	Volume:
Outer Carton	72 packs/carton	0.0211 cbm
Dimensions		
Blister (mm)	125(W) x 114(H) x 11(D)	
Inner Box (mm)	132(L) x 75(W) x 125(H)	
Outer Carton (cm)	42.5(L) x 33.5(W) x 14.8(H)	



4+2LR6

1.5V AA



Packaging		Gross Weight:
Blister	6 pcs/pack	11.8 kg
Inner Box	12 packs/box	Volume:
Outer Carton	72 packs/carton	0.0154 cbm
Dimensions		
Blister (mm)	140(W) x 114(H) x 15(D)	
Inner Box (mm)	131(L) x 98(W) x 150(H)	
Outer Carton (cm)	33.0(L) x 29.0(W) x 16.0(H)	



4+2LR03

1.5V AAA



Packaging		Gross Weight:
Blister	6 pcs/pack	12.8 kg
Inner Box	12 packs/box	Volume:
Outer Carton	144 packs/carton	0.0207 cbm
Dimensions		
Blister (mm)	125(W) x 114(H) x 11(D)	
Inner Box (mm)	132(L) x 75(W) x 125(H)	
Outer Carton (cm)	41.5(L) x 28.5(W) x 17.5(H)	



8+4LR6-BP

1.5V AA



Packaging		Gross Weight:
Shrink	12 pcs/pack	15.0 kg
Inner Box	6 packs/box	Volume:
Outer Carton	48 packs/carton	0.0190 cbm
Dimensions		
Shrink (mm)	125(W) x 114(H) x 29(D)	
Inner Box (mm)	132(L) x 100(W) x 137(H)	
Outer Carton (cm)	29.5(L) x 28.5(W) x 22.5(H)	



8+4LR03-BP

1.5V AAA



Packaging		Gross Weight:
Shrink	12 pcs/pack	12.2 kg
Inner Box	6 packs/box	Volume:
Outer Carton	72 packs/carton	0.0207 cbm
Dimensions		
Shrink (mm)	125(W) x 114(H) x 21(D)	
Inner Box (mm)	132(L) x 75(W) x 125(H)	
Outer Carton (cm)	41.5(L) x 28.5(W) x 17.5(H)	



4+2LR6-BP

1.5V AA



Packaging
Blister 6 pcs/pack
Inner Box 12 packs/box
Outer Carton 72 packs/carton

Gross Weight: 11.8 kg
Volume: 0.0160 cbm

Dimensions

Blister (mm) 125(W) x 114(H) x 15(D)
Inner Box (mm) 132(L) x 105(W) x 138(H)
Outer Carton (cm) 41.5(L) x 29.5(W) x 13.0(H)



4+2LR03-BP

1.5V AAA



Packaging
Blister 6 pcs/pack
Inner Box 12 packs/box
Outer Carton 144 packs/carton

Gross Weight: 12.8 kg
Volume: 0.0207 cbm

Dimensions

Blister (mm) 125(W) x 114(H) x 11(D)
Inner Box (mm) 132(L) x 75(W) x 125(H)
Outer Carton (cm) 41.5(L) x 28.5(W) x 17.5(H)



LR6-SP8

1.5V AA



Packaging
Shrink 8 pcs/pack
Inner Box 20 packs/box
Outer Carton 4 boxes/carton

Gross Weight: 15.5 kg
Volume: 0.0099 cbm

Dimensions

Inner Box (mm) 150(L) x 118(W) x 110(H)
Outer Carton (cm) 25.0(L) x 16.5(W) x 24.0(H)



LR03-SP8

1.5V AAA



Packaging
Shrink 8 pcs/pack
Inner Box 40 packs/box
Outer Carton 4 boxes/carton

Gross Weight: 15.5 kg
Volume: 0.0096 cbm

Dimensions

Inner Box (mm) 170(L) x 110(W) x 100(H)
Outer Carton (cm) 23.5(L) x 18.5(W) x 22.0(H)



LR14-SP6

1.5V C



Packaging
Shrink 6 pcs/pack
Inner Box 10 packs/box
Outer Carton 4 boxes/carton

Gross Weight: 16.7 kg
Volume: 0.0119 cbm

Dimensions

Inner Box (mm) 158(L) x 135(W) x 110(H)
Outer Carton (cm) 28.5(L) x 17.3(W) x 24.0(H)



LR20-SP6

1.5V D



Packaging
Shrink 6 pcs/pack
Inner Box 10 packs/box
Outer Carton 2 boxes/carton

Gross Weight: 16.8 kg
Volume: 0.0117 cbm

Dimensions

Inner Box (mm) 203(L) x 172(W) x 130(H)
Outer Carton (cm) 35.8(L) x 21.8(W) x 15.0(H)



LR6-SP16

1.5V AA



Packaging
Shrink 16 pcs/pack
Inner Box 10 packs/box
Outer Carton 4 boxes/carton

Gross Weight: 15.5 kg
Volume: 0.0099 cbm

Dimensions

Inner Box (mm) 150(L) x 118(W) x 110(H)
Outer Carton (cm) 25.0(L) x 16.5(W) x 24.0(H)



LR03-SP16

1.5V AAA



Packaging
Shrink 16 pcs/pack
Inner Box 20 packs/box
Outer Carton 4 boxes/carton

Gross Weight: 15.5 kg
Volume: 0.0096 cbm

Dimensions

Inner Box (mm) 170(L) x 110(W) x 100(H)
Outer Carton (cm) 23.5(L) x 18.5(W) x 22.0(H)



LR20-PB4

1.5V D



Packaging
Box 4 pcs/pack
Inner Box 6 packs/box
Outer Carton 24 packs/carton

Gross Weight: 14.8 kg
Volume: 0.0191 cbm

Dimensions

Plastic box (mm) 89(L) x 84(W) x 62 (H)
Inner Box (mm) 260(L) x 185(W) x 75(H)
Outer Carton (cm) 38.5(L) x 27.5(W) x 18.0(H)



LR14-PB4

1.5V C



Packaging
Box 4 pcs/pack
Inner Box 6 packs/box
Outer Carton 24 packs/carton

Gross Weight: 7.6 kg
Volume: 0.0112 cbm

Dimensions

Plastic box (mm) 73(L) x 68(W) x 50(H)
Inner Box (mm) 210(L) x 152(W) x 61(H)
Outer Carton (cm) 32.0(L) x 22.5(W) x 15.5(H)

Super Heavy Duty Batteries

Camelion Zinc Carbon batteries are a great choice for small household electronic devices that need continuous power such as clocks, flashlights, remote controls and transistor radios. Manganese dioxide is used for the positive material and zinc/ammmonium chloride for the electrolyte in a leakage proof structure. These, general purpose, batteries offer a long shelf life as well as reliability, versatility and savings.



R20P-BP2B
1.5V D
 4 260033 151018

Packaging
 Blister 2 pcs/pack
 Inner Box 6 packs/box
 Outer Carton 72 packs/carton

Gross Weight: 14.9 kg
Volume: 0.0238 cbm

Dimensions
 Blister (mm) 84(W) x 114(H) x 34(D)
 Inner Box (mm) 160(L) x 110(W) x 92(H)
 Outer Carton (cm) 33.5(L) x 29.0(W) x 24.5(H)



R14P-BP2B
1.5V C
 4 260033 151025

Packaging
 Blister 2 pcs/pack
 Inner Box 6 packs/box
 Outer Carton 144 packs/carton

Gross Weight: 15.6 kg
Volume: 0.0315 cbm

Dimensions
 Blister (mm) 84(W) x 114(H) x 27(D)
 Inner Box (mm) 137(L) x 86(W) x 86(H)
 Outer Carton (cm) 37.5(L) x 29.5(W) x 28.5(H)



R6P-BP4B
1.5V AA
 4 260033 151049

Packaging
 Blister 4 pcs/pack
 Inner Box 12 packs/box
 Outer Carton 240 packs/carton

Gross Weight: 17.5 kg
Volume: 0.0272cbm

Dimensions
 Blister (mm) 84(W) x 114(H) x 15(D)
 Inner Box (mm) 131(L) x 98(W) x 86(H)
 Outer Carton (cm) 45.0(L) x 27.5(W) x 22.0(H)



R03P-BP4B
1.5V AAA
 4 260033 151070

Packaging
 Blister 4 pcs/pack
 Inner Box 12 packs/box
 Outer Carton 288 packs/carton

Gross Weight: 14.6 kg
Volume: 0.0237cbm

Dimensions
 Blister (mm) 84(W) x 114(H) x 11(D)
 Inner Box (mm) 119(L) x 75(W) x 86(H)
 Outer Carton (cm) 32.5(L) x 26.0(W) x 28.0(H)



R6P-HP12B
1.5V AA
 4 260033 151438

Packaging
 Blister 12 pcs/pack
 Outer Carton 48 packs/carton

Gross Weight: 9.3 kg
Volume: 0.0098cbm

Dimensions
 Blister (mm) 170(W) x 100(H) x 15(D)
 Outer Carton (cm) 23.5(L) x 25.5(W) x 20.5(H)



6F22-BP1B
9V
 4 260033 151094

Packaging
 Blister 1 pcs/pack
 Inner Box 12 packs/box
 Outer Carton 240 packs/carton

Gross Weight: 11.4 kg
Volume: 0.0310 cbm

Dimensions
 Blister (mm) 84(W) x 114(H) x 18(D)
 Inner Box (mm) 123(L) x 117(W) x 86(H)
 Outer Carton (cm) 45.0(L) x 27.0(W) x 25.5(H)



R6P-SP4B
1.5V AA
 4 260033 151339

Packaging
 Shrink 4 pcs/pack
 Inner Box 12 packs/box
 Outer Carton 240 packs/carton

Gross Weight: 18.5 kg
Volume: 0.0161 cbm

Dimensions
 Shrink (mm) 56(W) x 50(H) x 14(D)
 Inner Box (mm) 118(L) x 92(W) x 56(H)
 Outer Carton (cm) 30.5(L) x 19.5(W) x 27.0(H)



R03P-SP4B
1.5V AAA
 4 260033 151353

Packaging
 Shrink 4 pcs/pack
 Inner Box 24 packs/box
 Outer Carton 480 packs/carton

Gross Weight: 14.2 kg
Volume: 0.0139 cbm

Dimensions
 Shrink (mm) 40(W) x 44.5(H) x 10(D)
 Inner Box (mm) 126(L) x 86(W) x 50(H)
 Outer Carton (cm) 36.0(L) x 26.5(W) x 14.5(H)



4R25-SP1B
6V
 4 260033 153531

Packaging
 Shrink 1 pcs/pack
 Inner Box 6 packs/box
 Outer Carton 12 packs/carton

Gross Weight: 6.7 kg
Volume: 0.0090 cbm

Dimensions
 Shrink (mm) 68.2(W) x 68.2(H) x 115 (D)
 Inner Box (mm) 205(L) x 135(W) x 120(H)
 Outer Carton (cm) 29.0(L) x 22.0(W) x 14.0(H)



R03P-SP2B
1.5V AAA
 4 260216 451164

Packaging
 Shrink 2 pcs/pack
 Inner Box 48 packs/box
 Outer Carton 960 packs/carton

Gross Weight: 14.2 kg
Volume: 0.0139 cbm

Dimensions
 Shrink (mm) 20(W) x 44.5(H) x 10(D)
 Inner Box (mm) 126(L) x 86(W) x 50(H)
 Outer Carton (cm) 36.0(L) x 26.5(W) x 14.5(H)



R20P-BP2G
1.5V D
 Packaging 4 260033 156280
 Blister 2 pcs/pack Gross Weight: 14.3 kg
 Inner Box 6 packs/box Volume:
 Outer Carton 72 packs/carton 0.0238cbm
Dimensions
 Blister (mm) 84(W) x 114(H) x 34(D)
 Inner Box (mm) 160(L) x 110(W) x 92(H)
 Outer Carton (cm) 33.5(L) x 29.0(W) x 24.5(H)



R20P-BP4G
1.5V D
 Packaging 4 260033 156358
 Blister 4 pcs/pack Gross Weight: 20.6 kg
 Inner Box 6 packs/box Volume:
 Outer Carton 54 packs/carton 0.0340cbm
Dimensions
 Blister (mm) 84(W) x 190(H) x 34(D)
 Inner Box (mm) 290(L) x 110(W) x 90(H)
 Outer Carton (cm) 31.0(L) x 30.5(W) x 36.0(H)



R14P-BP2G
1.5V C
 Packaging 4 260033 156297
 Blister 2 pcs/pack Gross Weight: 14.9 kg
 Inner Box 6 packs/box Volume:
 Outer Carton 144 packs/carton 0.0315 cbm
Dimensions
 Blister (mm) 84(W) x 114(H) x 27(D)
 Inner Box (mm) 137(L) x 86(W) x 86(H)
 Outer Carton (cm) 37.5(L) x 29.5(W) x 28.5(H)



R14P-BP4G
1.5V C
 Packaging 4 260033 156389
 Blister 4 pcs/pack Gross Weight: 10.4 kg
 Inner Box 6 packs/box Volume:
 Outer Carton 54 packs/carton 0.0245cbm
Dimensions
 Blister (mm) 84(W) x 165(H) x 27(D)
 Inner Box (mm) 240(L) x 90(W) x 90(H)
 Outer Carton (cm) 32.0(L) x 25.5(W) x 30.0(H)



R14P-BP6G
1.5V C
 Packaging 4 260033 150936
 Blister 6 pcs/pack Gross Weight: 15 kg
 Inner Box 4 packs/box Volume:
 Outer Carton 48 packs/carton 0.0336 cbm
Dimensions
 Blister (mm) 84(W) x 210(H) x 27(D)
 Inner Box (mm) 220(L) x 110(W) x 90(H)
 Outer Carton (cm) 46.5(L) x 24.5(W) x 29.5(H)



R6P-BP8G
1.5V AA
 Packaging 4 260033 156402
 Blister 8 pcs/pack Gross Weight: 9.5 kg
 Inner Box 12 packs/box Volume:
 Outer Carton 72 packs/carton 0.0198 cbm
Dimensions
 Blister (mm) 84(W) x 165(H) x 15(D)
 Inner Box (mm) 265(L) x 100(W) x 90(H)
 Outer Carton (cm) 31.5(L) x 28.0(W) x 22.5(H)



R6P-BP4G
1.5V AA
 Packaging 4 260033 156303
 Blister 4 pcs/pack Gross Weight: 16.3 kg
 Inner Box 12 packs/box Volume:
 Outer Carton 240 packs/carton 0.0272cbm
Dimensions
 Blister (mm) 84(W) x 114(H) x 15(D)
 Inner Box (mm) 131(L) x 98(W) x 86(H)
 Outer Carton (cm) 45.0(L) x 27.5(W) x 22.0(H)



R6P-BP10G
1.5V AA
 Packaging 4 260033 156396
 Blister 10 pcs/pack Gross Weight: 12.1 kg
 Inner Box 12 packs/box Volume:
 Outer Carton 72 packs/carton 0.0239 cbm
Dimensions
 Blister (mm) 84(W) x 190(H) x 15(D)
 Inner Box (mm) 315(L) x 104(W) x 90(H)
 Outer Carton (cm) 33.0(L) x 31.5(W) x 23.0(H)



R03P-BP4G
1.5V AAA
 Packaging 4 260033 156327
 Blister 4 pcs/pack Gross Weight: 12.0 kg
 Inner Box 12 packs/box Volume:
 Outer Carton 288 packs/carton 0.0237cbm
Dimensions
 Blister (mm) 84(W) x 114(H) x 11(D)
 Inner Box (mm) 119(L) x 75(W) x 86(H)
 Outer Carton (cm) 32.5(L) x 26.0(W) x 28.0(H)



R03P-BP8G
1.5V AAA
 Packaging 4 260033 156426
 Blister 8 pcs/pack Gross Weight: 6.6 kg
 Inner Box 12 packs/box Volume:
 Outer Carton 72 packs/carton 0.0132 cbm
Dimensions
 Blister (mm) 84(W) x 165(H) x 11(D)
 Inner Box (mm) 200(L) x 84(W) x 90(H)
 Outer Carton (cm) 30.0(L) x 22.0(W) x 20.0(H)



6F22-BP1G
9V
 Packaging 4 260033 156341
 Blister 1 pcs/pack **Gross Weight:** 11.4 kg
 Inner Box 12 packs/box **Volume:** 0.0310 cbm
 Outer Carton 240 packs/carton
Dimensions
 Blister (mm) 84(W) x 114(H) x 18(D)
 Inner Box (mm) 123(L) x 117(W) x 86(H)
 Outer Carton (cm) 45.0(L) x 27.0(W) x 25.5(H)



3R12-BP1G
4.5V
 Packaging 4 260033 156372
 Blister 1 pcs/pack **Gross Weight:** 15.4 kg
 Inner Box 6 packs/box **Volume:** 0.0290cbm
 Outer Carton 144 packs/carton
Dimensions
 Blister (mm) 84(W) x 114(H) x 23(D)
 Inner Box (mm) 160(L) x 75(W) x 86(H)
 Outer Carton (cm) 33.5(L) x 31.5(W) x 27.5(H)



2R10-BP1G
3V
 Packaging 4 260033 150943
 Blister 1 pcs/pack **Gross Weight:** 11.0 kg
 Inner Box 12 packs/box **Volume:** 0.0533 cbm
 Outer Carton 240 packs/carton
Dimensions
 Blister (mm) 84(W) x 124(H) x 14(D)
 Inner Box (mm) 156(L) x 115(W) x 125(H)
 Outer Carton (cm) 59.5(L) x 28.0(W) x 32.0(H)



R20P-SP2G
1.5V D
 Packaging 4 260033 156433
 Shrink 2 pcs/pack **Gross Weight:** 17.5 kg
 Inner Box 6 packs/box **Volume:** 0.0169 cbm
 Outer Carton 96 packs/carton
Dimensions
 Shrink (mm) 66(W) x 61(H) x 33(D)
 Inner Box (mm) 137(L) x 103(W) x 68(H)
 Outer Carton (cm) 28.5(L) x 22.0(W) x 27.0(H)



R14P-SP2G
1.5V C
 Packaging 4 260033 156440
 Shrink 2 pcs/pack **Gross Weight:** 13.2 kg
 Inner Box 6 packs/box **Volume:** 0.0129 cbm
 Outer Carton 144 packs/carton
Dimensions
 Shrink (mm) 52(W) x 50(H) x 26(D)
 Inner Box (mm) 104(L) x 78(W) x 50(H)
 Outer Carton (cm) 25.5(L) x 23.0(W) x 22.0(H)



R6P-SP2G
1.5V AA
 Packaging 4 260033 156464
 Shrink 2 pcs/pack **Gross Weight:** 15.5 kg
 Inner Box 30 packs/box **Volume:** 0.0127cbm
 Outer Carton 480 packs/carton
Dimensions
 Shrink (mm) 28(W) x 50(H) x 14(D)
 Inner Box (mm) 113(L) x 72(W) x 50(H)
 Outer Carton (cm) 30.5(L) x 22.0(W) x 19.0(H)



R6P-SP4G
1.5V AA
 Packaging 4 260033 156457
 Shrink 4 pcs/pack **Gross Weight:** 14.7 kg
 Inner Box 15 packs/box **Volume:** 0.0127cbm
 Outer Carton 240 packs/carton
Dimensions
 Shrink (mm) 56(W) x 50(H) x 14(D)
 Inner Box (mm) 174(L) x 72(W) x 50(H)
 Outer Carton (cm) 30.5(L) x 22.0(W) x 19.0(H)



R03P-SP2G
1.5V AAA
 Packaging 4 260033 156488
 Shrink 2 pcs/pack **Gross Weight:** 9.5 kg
 Inner Box 30 packs/box **Volume:** 0.0083 cbm
 Outer Carton 600 packs/carton
Dimensions
 Shrink (mm) 40(W) x 44.5(H) x 10(D)
 Inner Box (mm) 83(L) x 52(W) x 45(H)
 Outer Carton (cm) 28.5(L) x 20.0(W) x 14.5(H)



R03P-SP4G
1.5V AAA
 Packaging 4 260033 156471
 Shrink 4 pcs/pack **Gross Weight:** 10.0 kg
 Inner Box 15 packs/box **Volume:** 0.0083 cbm
 Outer Carton 300 packs/carton
Dimensions
 Shrink (mm) 40(W) x 44.5(H) x 10(D)
 Inner Box (mm) 125(L) x 52(W) x 45(H)
 Outer Carton (cm) 28.5(L) x 20.0(W) x 14.5(H)



6F22-SP1G
9V
 Packaging 4 260033 156495
 Shrink 1 pcs/pack **Gross Weight:** 19.0 kg
 Inner Box 12 packs/box **Volume:** 0.0144 cbm
 Outer Carton 480 packs/carton
Dimensions
 Shrink (mm) 25.5(W) x 48.5(H) x 17.5 (D)
 Inner Box (mm) 105(L) x 52(W) x 50(H)
 Outer Carton (cm) 29.0(L) x 22.5(W) x 22.0(H)



3R12-SP1G

4.5V



Packaging		Gross Weight:
Shrink	1 pcs/pack	16.6 kg
Inner Box	12 packs/box	Volume:
Outer Carton	144 packs/carton	0.0188 cbm
Dimensions		
Shrink (mm)	62(W) x 65.5 (H) x 22 (D)	
Inner Box (mm)	188(L) x 90(W) x 65(H)	
Outer Carton (cm)	39.0(L) x 21.0(W) x 23.0(H)	



4R25-SP1G

6V



Packaging		Gross Weight:
Shrink	1 pcs/pack	6.7 kg
Inner Box	6 packs/box	Volume:
Outer Carton	12 packs/carton	0.0090 cbm
Dimensions		
Shrink (mm)	68.5(W) x 68.5(H) x 115 (D)	
Inner Box (mm)	205(L) x 135(W) x 120(H)	
Outer Carton (cm)	29.0(L) x 22.0(W) x 14.0(H)	



FPG-GB40



Packaging	4 x R14P+24 x R6+	Gross Weight:
	12 x R03P+	13.0 kg
	1 x SL3013(Blue 3LR44)	Volume:
Outer Carton	18 boxes/carton	0.0223 cbm

Box (mm)	132(B) x 126(T) x 54(H)
Outer Carton (cm)	40.0 (L) x 28.0(W) x 19.5(H)

Shrink Wrap Packaging and Display Boxes

Handy Packaging!

Our shrink wrap packaging and display boxes help keep your batteries where you need them, with minimum loss.

- Convenient, portable and durable
- Self-standing, sturdy display boxes
- Many sizes and shapes available
- Securely hold several batteries
- Professional, branded card inserts and designs for effective messaging



R6P-SP8G

1.5V AA



Packaging		Gross Weight:
Shrink	8 pcs/pack	14.7 kg
Inner Box	20 packs/box	Volume:
Outer Carton	6 boxes/carton	0.0147 cbm
Dimensions		
Inner Box (mm)	150(L) x 118(W) x 110(H)	
Outer Carton (cm)	34.5(L) x 25.0(W) x 17.0(H)	

R6P-SP12G

1.5V AA



Packaging		Gross Weight:
Shrink	12 pcs/pack	16.5 kg
Inner Box	5 packs/box	Volume:
Outer Carton	80 boxes/carton	0.0127 cbm
Dimensions		
Inner Box (mm)	175(L) x 150(W) x 110(H)	
Outer Carton (cm)	31.5(L) x 19.0(W) x 24.0(H)	

R03P-SP8G

1.5V AAA



Packaging		Gross Weight:
Shrink	8 pcs/pack	15.3 kg
Inner Box	40 packs/box	Volume:
Outer Carton	6 boxes/carton	0.0141 cbm
Dimensions		
Inner Box (mm)	170(L) x 110(W) x 100(H)	
Outer Carton (cm)	31.5(L) x 23.5(W) x 19.0(H)	



Photo Lithium Batteries

Camelion Photo batteries are ideal for a wide range of analog cameras.



CR123A-BP1

3V



Packaging

Blister	1 pcs/pack	Gross Weight:	5.5 kg
Inner Box	10 packs/box	Volume:	0.0243 cbm
Outer Carton	200 packs/carton		

Dimensions

Blister (mm)	84(W) x 114(H) x 17.5(D)
Inner Box (mm)	118(L) x 95(W) x 85(H)
Outer Carton (cm)	45.0(L) x 25.0(W) x 21.5(H)



CR2-BP1

3V



Packaging

Blister	1 pcs/pack	Gross Weight:	4.5 kg
Inner Box	10 packs/box	Volume:	0.0215 cbm
Outer Carton	200 packs/carton		

Dimensions

Blister (mm)	84(W) x 114(H) x 16.5(D)
Inner Box (mm)	118(L) x 85(W) x 85(H)
Outer Carton (cm)	45.0(L) x 25.0(W) x 19.0(H)



CR-P2-BP1

6V



Packaging

Blister	1 pcs/pack	Gross Weight:	10.0 kg
Inner Box	10 packs/box	Volume:	0.0265 cbm
Outer Carton	200 packs/carton		

Dimensions

Blister (mm)	84(W) x 114(H) x 20.5(D)
Inner Box (mm)	118(L) x 105(W) x 85(H)
Outer Carton (cm)	45.0(L) x 25.0(W) x 23.5(H)



2CR5-BP1

6V



Packaging

Blister	1 pcs/pack	Gross Weight:	10.0 kg
Inner Box	10 packs/box	Volume:	0.0265 cbm
Outer Carton	200 packs/carton		

Dimensions

Blister (mm)	84(W) x 114(H) x 18(D)
Inner Box (mm)	118(L) x 105(W) x 85(H)
Outer Carton (cm)	45.0(L) x 25.0(W) x 23.5(H)

Electronic Button Cells

Camelion Electronic Button Cells provide stable energy for small electronic devices and are available in lithium, alkaline, silver oxide and zinc air chemistries, depending upon voltage and size requirements of your equipment. They are suitable for car keys, calculators, laser pointers, hearing aids and many other electronic gadgets.



Electronics Lithium 3V



ITEM	EAN	PACKAGING WxHxD(mm)	INNER BOX LxWxH(mm)	SHIPPING CARTON LxWxH(cm)	G.W.(KG)	VOLUME(CBM)
CR1216-BP1	4260033152831	56 x 92 x 3 1 PC / BLISTER	98 x 37 x 58 10 PACKS	45.5 x 31.5 x 31.5 1800 PACKS	9.5	0.0451
CR1220-BP1	4260033152824				8.0	
CR1225-BP1	4260033152817				8.0	
CR1616-BP1	4260033152800				8.0	
CR1620-BP1	4260033152794				8.5	
CR1632-BP1	4260033152923				10.4	
CR2016-BP1	4260033152787				9.5	
CR2025-BP1	4260033152770				11.0	
CR2032-BP1	4260033152763				12.0	
CR2320-BP1	4260033152756				11.5	
CR2325-BP1	4260033152848				12.0	
CR2330-BP1	4260033152749				13.0	
CR2430-BP1	4260033152732				13.5	
CR2450-BP1	4260033152725				17.5	
CR2477-BP1	4260216455353				17.72	
CR927-BP1	4260216452475				14.0	
CR1216-BP5	4260033152718	55x 190 x 3 5 PCS / BLISTER	195 x 90 x 58 30 PACKS	29.0 x 22.0 x 26.0 360 PACKS	4.5	0.0165
CR1220-BP5	4260033152701				4.5	
CR1225-BP5	4260033152695				5.0	
CR1616-BP5	4260033152688				5.5	
CR1620-BP5	4260033152671				5.5	
CR1632-BP5	4260216455797				6.5	
CR2016-BP5	4260033152664				8.0	
CR2025-BP5	4260033152657				9.0	
CR2032-BP5	4260033152640				5.5	
CR2430-BP5	4260216455803				12.2	
CR2450-BP5	4260216455810	16.7				
CRVP01-BP6	4260216456145	125x114x6.5 6 PCS / BLISTER	138 x 85 x 127 24 PACKS	29.5 x 27.5 x 28.0 288 PACKS	8.0	0.0227



Electronics Alkaline

1.5V

0% Hg



ITEM(0%Hg)	EAN	PACKAGING WxHxD(mm)	INNER BOX LxWxH(mm)	SHIPPING CARTON LxWxH(cm)	G.W. (KG)	VOLUME (CBM)
AG1-BP2(0%Hg)	4260216454783	56 x 92 x 5 2 PC / BLISTER	95 x 63 x 58 20 PACKS	39.5 x 30.5 x 31.5 1800 PACKS	7.0	0.0379
AG2-BP2(0%Hg)	4260216454790				7.8	
AG3-BP2(0%Hg)	4260216454806				8.0	
AG4-BP2(0%Hg)	4260216454622				7.0	
AG5-BP2(0%Hg)	4260216454813	56 x 92 x 7 2 PC / BLISTER	98 x 73 x 58 20 PACKS	45.5 x 31.5 x 31.5 1800 PACKS	9.0	0.0451
AG6-BP2(0%Hg)	4260216454820	56 x 92 x 5 2 PC / BLISTER	95 x 63 x 58 20 PACKS	39.5 x 30.5 x 31.5 1800 PACKS	8.0	0.0379
AG7-BP2(0%Hg)	4260216454837				8.5	
AG8-BP2(0%Hg)	4260216454844				9.0	
AG9-BP2(0%Hg)	4260216454851				9.0	
AG10-BP2(0%Hg)	4260216454608				10.0	
AG11-BP2(0%Hg)	4260216454868				7.0	
AG12-BP2(0%Hg)	4260216454875	56 x 92 x 7 2 PC / BLISTER	98 x 73 x 58 20 PACKS	45.5 x 31.5 x 31.5 1800 PACKS	11.0	0.0451
AG13-BP2(0%Hg)	4260216454615	13.0				
625A-BP1(0%Hg)	4260216454882	56 x 92 x 7 1 PC / BLISTER	146 x 98 x 58 40 PACKS	45.5 x 31.5 x 31.5 1800 PACKS	18.0	0.0451
AG0-BP10(0%Hg)	4260216454899	50x 160 x 5 10 PCS / BLISTER	170 x 40 x 52 20 PACKS	50.0 x 20.0 x 20.0 360 PACKS	4.0	0.0198
AG1-BP10(0%Hg)	4260216454905				4.0	
AG2-BP10(0%Hg)	4260216454912				4.5	
AG3-BP10(0%Hg)	4260216454929				5.0	
AG4-BP10(0%Hg)	4260216454400				4.0	
AG5-BP10(0%Hg)	4260216454936				6.5	
AG6-BP10(0%Hg)	4260216454943				5.0	
AG7-BP10(0%Hg)	4260216454950				5.5	
AG8-BP10(0%Hg)	4260216454967				6.0	
AG9-BP10(0%Hg)	4260216454974				6.0	
AG10-BP10(0%Hg)	4260216454981				7.0	
AG11-BP10(0%Hg)	4260216454998				4.0	
AG12-BP10(0%Hg)	4260216455001				8.7	
AG13-BP10(0%Hg)	4260216455018				10.0	

0% Hg



Industrial Classifications

AG0	LR521	G0			379
AG1	LR621	G1	LR60	164	364
AG2	LR726	G2	LR59	196	396
AG3	LR41	G3	LR41	192	392
AG4	LR626	G4	LR66	177	377
AG5	LR754	G5	LR48	193	393
AG6	LR921	G6	LR69	171	371
AG7	LR926	G7	LR57	195	395
AG8	LR1120	G8	LR55	191	391
AG9	LR936	G9	LR45	194	394
AG10	LR1130	G10	LR54	189	389
AG11	LR721	G11	LR58	162	362
AG12	LR43	G12	LR43	186	386
AG13	LR44	G13	LR44	A76	357

Remote Control Batteries

6V/12V



ITEM(0% Hg)	EAN	Voltage (V)	PACKAGING WxHxD(mm)	INNER BOX LxWxH(mm)	SHIPPING CARTON LxWxH(cm)	G. W. (KG)	VOLUME (CBM)	
A11-BP1(0%Hg)	4260216455049	6V	56 x 92 x 10 1 PC / BLISTER	125 x 95 x 58 20 PACKS	39.5 x 30.5 x 31.5 900 PACKS	7.6	0.0380	
A23-BP1(0%Hg)	4260216455056	12V				8.6		
A27-BP1(0%Hg)	4260216455063	12V				8.0		
LR32A-BP1(0%Hg)	4260216455070	9V				6.0		
A23-BP5(0%Hg)	4260216455087	12V				18.0		0.0273
A27-BP5(0%Hg)	4260216455094	12V				12.0		



4LR44-BP1C(0%Hg)

6V



Packaging
Blister 1 pcs/pack
Inner Box 20 packs/box
Outer Carton 900 packs/carton

Gross Weight: 15.0 kg
Volume: 0.0451 cbm

Dimensions
Blister (mm) 56(W)x 92(H) x (D)
Inner Box (mm) 145(L)x 95(W) x 58(H)
Outer Carton (cm) 45.5(L)x 31.5(W) x 31.5(H)



4LR44-BP5(0%Hg)

6V



Packaging
Blister 5 pcs/pack
Inner Box 6 packs/box
Outer Carton 192 packs/carton

Gross Weight: 13.2 kg
Volume: 0.0150 cbm

Dimensions
Blister (mm) 50(W) x 160(H) x (D)
Inner Box (mm) 170(L) x 78(W) x 52(H)
Outer Carton (cm) 33.5(L) x 19.0(W) x 23.5(H)

Industrial Classifications

SG0	SR521	G0	SR63	379
SG1	SR621	G1	SR60	364
SG2	SR726	G2	SR59	396
SG3	SR41	G3	SR41	392
SG4	SR626	G4	SR66	377
SG5	SR754	G5	SR48	393
SG6	SR921	G6	SR69	371
SG7	SR926	G7	SR57	395
SG8	SR1120	G8	SR55	391
SG9	SR936	G9	SR45	394
SG10	SR1130	G10	SR54	389
SG11	SR721	G11	SR58	362
SG12	SR43	G12	SR43	386
SG13	SR44	G13	SR44	357

Electronics Silver Oxide 1.55V

0% Hg



ITEM(0% Hg)	EAN	PACKAGING WxHxD(mm)	INNER BOX LxWxH(mm)	SHIPPING CARTON LxWxH(cm)	G. W. (KG)	VOLUME (CBM)
SR41-BP1(0%Hg)	4260216455117	55x 92 x 5 1 PC / BLISTER	145 x 95 x 58 40 PACKS	45.5 x 31.5 x 31.5 1800 PACKS	8.5	0.0451
SR43-BP1(0%Hg)	4260216455124				10.5	
SR44-BP1(0%Hg)	4260216455131				11.5	
SR54-BP1(0%Hg)	4260216455148				9.5	
SR57-BP1(0%Hg)	4260216455155				8.5	
SR58-BP1(0%Hg)	4260216455162				8	
SR59-BP1(0%Hg)	4260216455179				8	
SR60-BP1(0%Hg)	4260216455186				8	
SR63-BP1(0%Hg)	4260216455193				7.5	
SR66-BP1(0%Hg)	4260216455209				8	
SR69-BP1(0%Hg)	4260216455216	9.5				
SR41-BP5(0%Hg)	4260216455223	55x 190 x 5 5 PCS / BLISTER	195 x 90 x 58 20 PACKS	37.0 x 21.7 x 29.5 360 PACKS	4.5	0.0237
SR43-BP5(0%Hg)	4260216455230				6.5	
SR44-BP5(0%Hg)	4260216455247				7.5	
SR54-BP5(0%Hg)	4260216455254				5.5	
SR57-BP5(0%Hg)	4260216455261				4.5	
SR58-BP5(0%Hg)	4260216455278				4	
SR59-BP5(0%Hg)	4260216455285				4	
SR60-BP5(0%Hg)	4260216455292				4	
SR63-BP5(0%Hg)	4260216455308				3.5	
SR66-BP5(0%Hg)	4260216455315				4	
SR69-BP5(0%Hg)	4260216455322	5.5				

4SR44-BP1C(0% Hg)

6.2V



4 260216 455032

Packaging

Blister 1 pcs/pack
Inner Box 20 packs/box
Outer Carton 900 packs/carton

Gross Weight: 15.0 kg
Volume: 0.0451 cbm

Dimensions

Blister (mm) 55(W)x 92(H) x 5(D)
Inner Box (mm) 145(L)x 95(W) x 58(H)
Outer Carton (cm) 45.5(L)x 31.5(W) x 31.5(H)

0% Hg



Zinc Air 1.4V

Camelion Hearing Aid batteries are light and reliable. They are conveniently packaged to make them easy to use.



ITEM	EAN	WxHxD (mm)	PACKAGING	WxHxD (mm)	INNER BOX	WxHxD (mm)	INNER CARTON	WxHxD (cm)	SHIPPING CARTON	G. W. (KG)	VOLUME (CBM)
A13-BP6(0%Hg)	4260216454417	48 x 90 x 6.5	6PCS/Blister	92 x42 x 50	10 Packs	245 x 120 x 130	100 Packs	62 x 26 x 15	500 Packs	6.5	0.0242
A10-BP6(0%Hg)	4260216454486	48 x 90 x 4.5	6PCS/Blister	92 x32 x 50	10 Packs	195 x 120 x 130	100 Packs	62 x 21 x 15	500 Packs	6.0	0.0196
A675-BP6(0%Hg)	4260216454493	48 x 90 x 6.5	6PCS/Blister	92 x42 x 50	10 Packs	245 x 120 x 130	100 Packs	62 x 26 x 15	500 Packs	9.5	0.0242
A312-BP6(0%Hg)	4260216454509	48 x 90 x 4.5	6PCS/Blister	92 x32 x 50	10 Packs	195 x 120 x 130	100 Packs	62 x 21 x 15	500 Packs	6.5	0.0196

Battery Adapter



For Rechargeable & Non-Rechargeable Batteries



AA Battery+Adapter

D or C Size



Warning:

When using two or more adapters together, avoid mixing new and used batteries, batteries with different charge levels or different types and brands. Don't mix adapters with actual D batteries in the device. Please insert the AA batteries into the adapter correctly. Remove battery after use, or when not in use. Store adapter separately from battery. Do not recharge battery while in the adapter.

Battery Case

Main Features

- Durable plastic case holds up to 4 AA/AAA batteries.
- Keep your batteries together and safe.

Directions

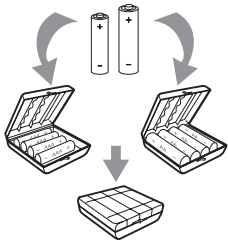

Battery Tester



BT-0503

Tests AA, AAA, C, D, 9V and some models of button cell

MAIN FEATURES

- Quickly determines if battery needs charging or replacing
- On the spot testing – just insert and check LED
- Compact & light

• Insert battery: Observe polarity

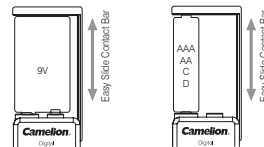

• Check LED indicator: If LED fluctuates press slightly

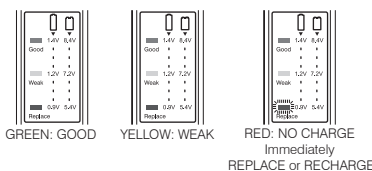

BT-0503



Packaging



















Blister	1 pcs/pack
Inner Box	60 packs/box
Outer Carton	240 packs/carton

Gross Weight:	8.7 kg
Volume:	0.0388 cbm

Dimensions

Blister (mm)	65(W)x 154(H) x 16(D)
Inner Box (cm)	44(L)x 11.5(W) x 16.5(H)
Outer Carton (cm)	45(L)x 34.5(W) x 25(H)

Battery Selection Chart

<p>Lithium P7 Batteries</p> 	
<p>Digi Alkaline Batteries</p> 	
<p>Plus Alkaline Batteries</p> 	
<p>Super Heavy Duty Batteries</p> 	
<p>Photo Lithium Batteries</p> 	
<p>9V Lithium Battery</p> 	
<p>Micro Batteries: Lithium</p> 	
<p>Micro Batteries: Alkaline</p> 	
<p>Hearing Aid Zinc Air</p> 	

Please Note:

These are suggested recommendations only.
 For the most accurate information please refer to your device manufacturer's manual.
 Camelion is not responsible for accidents resulting from the use of this information

Specifications

	Lithium P7		Digi Alkaline		Plus Alkaline							Super Heavy Duty							
	FR6	FR03	LR6	LR03	LR20	LR14	LR6	LR03	LR61	6LF22**	3LR12	R6	R03	R20	R14	6F22**	3R12*	4R25**	R10
Nominal Voltage(V)	1.5	1.5	1.5	1.5	1.5	1.5	1.5	1.5	1.5	9	4.5	1.5	1.5	1.5	1.5	9	4.5	6	1.5
Average Capacity(mAh)	2800	1100	2800	1100	18000	8500	2800	1100	600	190**	2700*	950	460	5600	2400	450	1700	7000	500

20+-2°C, Rated capacity at 25 mA continuous drain, to 0.8V
 * 20+-2°C, Rated capacity at 25 mA continuous drain, to 2.7V
 ** 20+-2°C, Rated capacity at 25 mA continuous drain, to 4.8V

Rechargeable

AlwaysReady™

Ni-MH Always Ready Rechargeable Batteries

The new Camelion AlwaysReady battery is ready to be used right from the package. **It holds the charge for up to a year.** And they can be recharged again and again, saving you money. Are you ready? Try AlwaysReady batteries today!

MAX ——— Maximum capacity, ideal for professional use



NH-AA2500ARBP4

1.2V AA	
4 260216 453045	
Packaging	
Blister	4 pcs/pack
Inner Box	12 packs/box
Outer Carton	96 packs/carton
Dimensions	
Blister (mm)	90(W) x 117(H) x 15(D)
Inner Box (mm)	134(L) x 104(W) x 97(H)
Outer Carton (cm)	29.0(L) x 21.5(W) x 23.0(H)
Gross Weight:	12.0 kg
Volume:	0.0144 cbm



NH-AA2500ARBP2

1.2V AA	
4 260216 453038	
Packaging	
Blister	2 pcs/pack
Inner Box	12 packs/box
Outer Carton	192 packs/carton
Dimensions	
Blister (mm)	90(W) x 117(H) x 15(D)
Inner Box (mm)	134(L) x 104(W) x 97(H)
Outer Carton (cm)	41.0(L) x 29.0(W) x 23.0(H)
Gross Weight:	13.1 kg
Volume:	0.0274 cbm



PREMIUM ——— Suitable for all high drain devices



NH-AA2300ARBP4

1.2V AA	
4 260033 154040	
Packaging	
Blister	4 pcs/pack
Inner Box	12 packs/box
Outer Carton	96 packs/carton
Dimensions	
Blister (mm)	90(W) x 117(H) x 15(D)
Inner Box (mm)	134(L) x 104(W) x 97(H)
Outer Carton (cm)	29.0(L) x 21.5(W) x 23.0(H)
Gross Weight:	11.8 kg
Volume:	0.0144 cbm



NH-AA2300ARBP2

1.2V AA	
4 260033 152336	
Packaging	
Blister	2 pcs/pack
Inner Box	12 packs/box
Outer Carton	192 packs/carton
Dimensions	
Blister (mm)	90(W) x 117(H) x 15(D)
Inner Box (mm)	134(L) x 104(W) x 97(H)
Outer Carton (cm)	41.0(L) x 29.0(W) x 23.0(H)
Gross Weight:	12.9 kg
Volume:	0.0274 cbm



NH-AA2100ARBP4

1.2V AA	
4 260033 152282	
Packaging	
Blister	4 pcs/pack
Inner Box	12 packs/box
Outer Carton	96 packs/carton
Dimensions	
Blister (mm)	90(W) x 117(H) x 15(D)
Inner Box (mm)	134(L) x 104(W) x 97(H)
Outer Carton (cm)	29.0(L) x 21.5(W) x 23.0(H)
Gross Weight:	11.7 kg
Volume:	0.0143 cbm



NH-AA2100ARBP2

1.2V AA	
4 260033 152275	
Packaging	
Blister	2 pcs/pack
Inner Box	12 packs/box
Outer Carton	192 packs/carton
Dimensions	
Blister (mm)	90(W) x 117(H) x 15(D)
Inner Box (mm)	134(L) x 104(W) x 97(H)
Outer Carton (cm)	41.0(L) x 29.0(W) x 23.0(H)
Gross Weight:	12.7 kg
Volume:	0.0273 cbm





NH-AAA800ARBP4

1.2V AAA



Packaging 4 260033 152312
 Blister 4 pcs/pack Gross Weight: 9.2 kg
 Inner Box 12 packs/box Volume:
 Outer Carton 144 packs/carton 0.0168 cbm

Dimensions

Blister (mm) 90(W) x 117(H) x 11(D)
 Inner Box (mm) 125(L) x 84(W) x 97(H)
 Outer Carton (cm) 31.0(L) x 27.0(W) x 20.0(H)



NH-AAA800ARBP2

1.2V AAA



Packaging 4 260033 152305
 Blister 2 pcs/pack Gross Weight: 8.4 kg
 Inner Box 12 packs/box Volume:
 Outer Carton 240 packs/carton 0.0269 cbm

Dimensions

Blister (mm) 90(W) x 117(H) x 11(D)
 Inner Box (mm) 125(L) x 84(W) x 97(H)
 Outer Carton (cm) 51.0(L) x 27.0(W) x 19.5(H)



NH-9V200ARBP1

9V



Packaging 4 260033 1155221
 Blister 1 pcs/pack Gross Weight: 12.0 kg
 Inner Box 12 packs/box Volume:
 Outer Carton 240 packs/carton 0.0385 cbm

Dimensions

Blister (mm) 90(W) x 117(H) x 18(D)
 Inner Box (mm) 135(L) x 125(W) x 97(H)
 Outer Carton (cm) 51.0(L) x 29.0(W) x 26.0(H)

LONG LIFE ——— Maximum rechargeable life cycle up to 1500 cycles



NH-AA800ARBP2

1.2V AA



Packaging 4 260216 4453236
 Blister 2 pcs/pack Gross Weight: 12.4 kg
 Inner Box 12 packs/box Volume:
 Outer Carton 192 packs/carton 0.0274 cbm

Dimensions

Blister (mm) 90(W) x 117(H) x 15(D)
 Inner Box (mm) 134(L) x 104(W) x 97(H)
 Outer Carton (cm) 41.0(L) x 29.0(W) x 23.0(H)



NH-AA600ARBP4

1.2V AA



Packaging 4 260216 4455667
 Blister 4 pcs/pack Gross Weight: 11.4 kg
 Inner Box 12 packs/box Volume:
 Outer Carton 96 packs/carton 0.0144 cbm

Dimensions

Blister (mm) 90(W) x 117(H) x 15(D)
 Inner Box (mm) 134(L) x 104(W) x 97(H)
 Outer Carton (cm) 29.0(L) x 21.5(W) x 23.0(H)



NH-AAA600ARBP4

1.2V AAA



Packaging 4 260216 4455674
 Blister 4 pcs/pack Gross Weight: 8.6 kg
 Inner Box 12 packs/box Volume:
 Outer Carton 144 packs/carton 0.0168 cbm

Dimensions

Blister (mm) 90(W) x 117(H) x 11(D)
 Inner Box (mm) 125(L) x 84(W) x 97(H)
 Outer Carton (cm) 31.0(L) x 27.0(W) x 20.0(H)



Ni-MH Rechargeable Batteries

Camelion Ni-MH Rechargeable batteries offer high capacity performance, up to 1000 recharge cycles, and because they are used again and again they help reduce environmental waste. High drain devices such as music players and digital cameras are supported, therefore, you can hear more songs and take more photos.



NH-D7000BP2

1.2V D

4 260033 151520

Packaging	2 pcs/pack	Gross Weight:	19.0 kg
Blister	6 packs/box	Volume:	0.0234 cbm
Inner Box			
Outer Carton	60 packs/carton		

Dimensions

Blister (mm)	90(W) x 117(H) x 34(D)
Inner Box (mm)	160(L) x 112(W) x 97(H)
Outer Carton (cm)	34.0(L) x 27.5(W) x 25.0(H)



NH-D2500BP2

1.2V D

4 260033 151537

Packaging	2 pcs/pack	Gross Weight:	11.2 kg
Blister	6 packs/box	Volume:	0.0234 cbm
Inner Box			
Outer Carton	60 packs/carton		

Dimensions

Blister (mm)	90(W) x 117(H) x 34(D)
Inner Box (mm)	160(L) x 112(W) x 97(H)
Outer Carton (cm)	34.0(L) x 27.5(W) x 25.0(H)



NH-C3500BP2

1.2V C

4 260033 151544

Packaging	2 pcs/pack	Gross Weight:	16.8 kg
Blister	6 packs/box	Volume:	0.0248 cbm
Inner Box			
Outer Carton	96 packs/carton		

Dimensions

Blister (mm)	90(W) x 117(H) x 27(D)
Inner Box (mm)	138(L) x 90(W) x 97(H)
Outer Carton (cm)	41.0(L) x 29.5(W) x 20.5(H)



NH-C2500BP2

1.2V C

4 260033 151551

Packaging	2 pcs/pack	Gross Weight:	16.0 kg
Blister	6 packs/box	Volume:	0.0248 cbm
Inner Box			
Outer Carton	96 packs/carton		

Dimensions

Blister (mm)	90(W) x 117(H) x 27(D)
Inner Box (mm)	138(L) x 90(W) x 97(H)
Outer Carton (cm)	41.0(L) x 29.5(W) x 20.5(H)



NH-AA2700BC4

1.2V AA

4 260033 151933

Packaging	4 pcs/pack	Gross Weight:	13.4 kg
Blister	12 packs/box	Volume:	0.0144 cbm
Inner Box			
Outer Carton	96 packs/carton		

Dimensions

Blister (mm)	90(W) x 117(H) x 15(D)
Inner Box (mm)	134(L) x 104(W) x 97(H)
Outer Carton (cm)	29.0(L) x 21.5(W) x 23.0(H)



NH-AA2700BC2

1.2V AA

4 260033 151926

Packaging	2 pcs/pack	Gross Weight:	14.0 kg
Blister	12 packs/box	Volume:	0.0274 cbm
Inner Box			
Outer Carton	192 packs/carton		

Dimensions

Blister (mm)	90(W) x 117(H) x 15(D)
Inner Box (mm)	134(L) x 104(W) x 97(H)
Outer Carton (cm)	41.0(L) x 29.0(W) x 23.0(H)

NH-D10000BP2

1.2V D

4 260033 151865

Packaging	2 pcs/pack	Gross Weight:	17.0 kg
Blister	6 packs/box	Volume:	0.0244 cbm
Inner Box			
Outer Carton	48 packs/carton		

Dimensions

Blister (mm)	90(W) x 117(H) x 34(D)
Inner Box (mm)	165(L) x 135(W) x 105(H)
Outer Carton (cm)	43.5(L) x 35.0(W) x 16.0(H)



NH-AA2500BC4

1.2V AA



Packaging 4 260033 151834
 Blister 4 pcs/pack Gross Weight: 13.0 kg
 Inner Box 12 packs/box Volume:
 Outer Carton 96 packs/carton 0.0144 cbm

Dimensions

Blister (mm) 90(W) x 117(H) x 15(D)
 Inner Box (mm) 134(L) x 104(W) x 97(H)
 Outer Carton (cm) 29.0(L) x 21.5(W) x 23.0(H)



NH-AA2500BC2

1.2V AA



Packaging 4 260033 151827
 Blister 2 pcs/pack Gross Weight: 14.3 kg
 Inner Box 12 packs/box Volume:
 Outer Carton 192 packs/carton 0.0274 cbm

Dimensions

Blister (mm) 90(W) x 117(H) x 15(D)
 Inner Box (mm) 134(L) x 104(W) x 97(H)
 Outer Carton (cm) 41.0(L) x 29.0(W) x 23.0(H)



NH-AA2300BP4

1.2V AA



Packaging 4 260033 151742
 Blister 4 pcs/pack Gross Weight: 12.6 kg
 Inner Box 12 packs/box Volume:
 Outer Carton 96 packs/carton 0.0144 cbm

Dimensions

Blister (mm) 90(W) x 117(H) x 15(D)
 Inner Box (mm) 134(L) x 104(W) x 97(H)
 Outer Carton (cm) 29.0(L) x 21.5(W) x 23.0(H)



NH-AA2300BP2

1.2V AA



Packaging 4 260033 151735
 Blister 2 pcs/pack Gross Weight: 13.9 kg
 Inner Box 12 packs/box Volume:
 Outer Carton 192 packs/carton 0.0274 cbm

Dimensions

Blister (mm) 90(W) x 117(H) x 15(D)
 Inner Box (mm) 134(L) x 104(W) x 97(H)
 Outer Carton (cm) 41.0(L) x 29.0(W) x 23.0(H)



NH-AA2000BP2

1.2V AA



Packaging 4 260033 151582
 Blister 2 pcs/pack Gross Weight: 13.1 kg
 Inner Box 12 packs/box Volume:
 Outer Carton 192 packs/carton 0.0274 cbm

Dimensions

Blister (mm) 90(W) x 117(H) x 15(D)
 Inner Box (mm) 134(L) x 104(W) x 97(H)
 Outer Carton (cm) 41.0(L) x 29.0(W) x 23.0(H)



NH-AA1800BP4

1.2V AA



Packaging 4 260033 151612
 Blister 4 pcs/pack Gross Weight: 11.8 kg
 Inner Box 12 packs/box Volume:
 Outer Carton 96 packs/carton 0.0144 cbm

Dimensions

Blister (mm) 90(W) x 117(H) x 15(D)
 Inner Box (mm) 134(L) x 104(W) x 97(H)
 Outer Carton (cm) 29.0(L) x 21.5(W) x 23.0(H)



NH-AA1800BP2

1.2V AA



Packaging 4 260033 151605
 Blister 2 pcs/pack
 Inner Box 12 packs/box
 Outer Carton 192 packs/carton
 Gross Weight: 12.7 kg
 Volume: 0.0274 cbm

Dimensions

Blister (mm) 90(W) x 117(H) x 15(D)
 Inner Box (mm) 134(L) x 104(W) x 97(H)
 Outer Carton (cm) 41.0(L) x 29.0(W) x 23.0(H)



NH-AA1500BP2

1.2V AA



Packaging 4 260033 151629
 Blister 2 pcs/pack
 Inner Box 12 packs/box
 Outer Carton 192 packs/carton
 Gross Weight: 11.2 kg
 Volume: 0.0274 cbm

Dimensions

Blister (mm) 90(W) x 117(H) x 15(D)
 Inner Box (mm) 134(L) x 104(W) x 97(H)
 Outer Carton (cm) 41.0(L) x 29.0(W) x 23.0(H)



NH-AAA1100BP4

1.2V AAA



Packaging 4 260033 151957
 Blister 4 pcs/pack
 Inner Box 12 packs/box
 Outer Carton 144 packs/carton
 Gross Weight: 9.8 kg
 Volume: 0.0168 cbm

Dimensions

Blister (mm) 90(W) x 117(H) x 11(D)
 Inner Box (mm) 125(L) x 84(W) x 97(H)
 Outer Carton (cm) 31.0(L) x 27.0(W) x 20.0(H)



NH-AAA1100BP2

1.2V AAA



Packaging 4 260033 151940
 Blister 2 pcs/pack
 Inner Box 12 packs/box
 Outer Carton 240 packs/carton
 Gross Weight: 9.7 kg
 Volume: 0.0269 cbm

Dimensions

Blister (mm) 90(W) x 117(H) x 11(D)
 Inner Box (mm) 125(L) x 84(W) x 97(H)
 Outer Carton (cm) 51.0(L) x 27.0(W) x 19.5(H)



NH-AAA1000BP4

1.2V AAA



Packaging 4 260033 151889
 Blister 4 pcs/pack
 Inner Box 12 packs/box
 Outer Carton 144 packs/carton
 Gross Weight: 8.7 kg
 Volume: 0.0168 cbm

Dimensions

Blister (mm) 90(W) x 117(H) x 11(D)
 Inner Box (mm) 125(L) x 84(W) x 97(H)
 Outer Carton (cm) 31.0(L) x 27.0(W) x 20.0(H)



NH-AAA1000BP2

1.2V AAA



Packaging 4 260033 151872
 Blister 2 pcs/pack
 Inner Box 12 packs/box
 Outer Carton 240 packs/carton
 Gross Weight: 8.7 kg
 Volume: 0.0269 cbm

Dimensions

Blister (mm) 90(W) x 117(H) x 11(D)
 Inner Box (mm) 125(L) x 84(W) x 97(H)
 Outer Carton (cm) 51.0(L) x 27.0(W) x 19.5(H)



NH-AAA900BP4

1.2V AAA



Packaging 4 260033 151766
 Blister 4 pcs/pack
 Inner Box 12 packs/box
 Outer Carton 144 packs/carton
 Gross Weight: 8.7 kg
 Volume: 0.0168 cbm

Dimensions

Blister (mm) 90(W) x 117(H) x 11(D)
 Inner Box (mm) 125(L) x 84(W) x 97(H)
 Outer Carton (cm) 31.0(L) x 27.0(W) x 20.0(H)



NH-AAA900BP2

1.2V AAA



Packaging 4 260033 151759
 Blister 2 pcs/pack
 Inner Box 12 packs/box
 Outer Carton 240 packs/carton
 Gross Weight: 8.7 kg
 Volume: 0.0269 cbm

Dimensions

Blister (mm) 90(W) x 117(H) x 11(D)
 Inner Box (mm) 125(L) x 84(W) x 97(H)
 Outer Carton (cm) 51.0(L) x 27.0(W) x 19.5(H)



NH-AAA800BP4

1.2V AAA



Packaging
Blister 4 pcs/pack
Inner Box 12 packs/box
Outer Carton 144 packs/carton

Gross Weight: 7.8 kg
Volume: 0.0168 cbm

Dimensions

Blister (mm) 90(W) x 117(H) x 11(D)
Inner Box (mm) 125(L) x 84(W) x 97(H)
Outer Carton (cm) 31.0(L) x 27.0(W) x 20.0(H)



NH-AAA800BP2

1.2V AAA



Packaging
Blister 2 pcs/pack
Inner Box 12 packs/box
Outer Carton 240 packs/carton

Gross Weight: 7.7 kg
Volume: 0.0269 cbm

Dimensions

Blister (mm) 90(W) x 117(H) x 11(D)
Inner Box (mm) 125(L) x 84(W) x 97(H)
Outer Carton (cm) 51.0(L) x 27.0(W) x 19.5(H)



NH-AAA600BP4

1.2V AAA



Packaging
Blister 4 pcs/pack
Inner Box 12 packs/box
Outer Carton 144 packs/carton

Gross Weight: 7.8 kg
Volume: 0.0168 cbm

Dimensions

Blister (mm) 90(W) x 117(H) x 11(D)
Inner Box (mm) 125(L) x 84(W) x 97(H)
Outer Carton (cm) 31.0(L) x 27.0(W) x 20.0(H)



NH-AAA600BP2

1.2V AAA



Packaging
Blister 2 pcs/pack
Inner Box 12 packs/box
Outer Carton 240 packs/carton

Gross Weight: 7.7 kg
Volume: 0.0269 cbm

Dimensions

Blister (mm) 90(W) x 117(H) x 11(D)
Inner Box (mm) 125(L) x 84(W) x 97(H)
Outer Carton (cm) 51.0(L) x 27.0(W) x 19.5(H)



NH-9V250BP1

9V Voltage: 8.4V



Packaging
Blister 1 pcs/pack
Inner Box 12 packs/box
Outer Carton 240 packs/carton

Gross Weight: 12.3 kg
Volume: 0.0385 cbm

Dimensions

Blister (mm) 90(W) x 117(H) x 18(D)
Inner Box (mm) 135(L) x 125(W) x 97(H)
Outer Carton (cm) 51.0(L) x 29.0(W) x 26.0(H)



NH-9V200BP1

9V Voltage: 8.4V



Packaging
Blister 1 pcs/pack
Inner Box 12 packs/box
Outer Carton 240 packs/carton

Gross Weight: 11.6 kg
Volume: 0.0385 cbm

Dimensions

Blister (mm) 90(W) x 117(H) x 18(D)
Inner Box (mm) 135(L) x 125(W) x 97(H)
Outer Carton (cm) 51.0(L) x 29.0(W) x 26.0(H)

Battery Chargers



> Ultra Fast Chargers

Offer the ultimate in speed charging. In as little as one hour one can use the same batteries again, saving time and money.

Camelion®

BC-0907

Charges:

1-4 × AA

1-4 × AAA

Ni-MH



AC Adapter



Car Adapter



SPECIFICATIONS

AC To DC Adapter

Input: 100-240V ~ 50/60Hz

Output : 12V =

Car Plug

Output : 12V =

Charger

Charging Currents

4x(1.4V = 2200 mA) AA Size

4x(1.4V = 800 mA) AAA Size

MAIN FEATURES

- **4 Independent Charging Channels**
- **6 Level Charge Protection**
 - ΔV Cut-Off
 - Timer Control Protection (1.5 hours)
 - Over Temperature Protection
 - Reverse Polarity Protection
 - Over Current and Short Circuit Protection
 - Defective and Non-rechargeable Battery Detection
- **Low Current Leakage** Minimizes loss of capacity and maintains battery charge by controlling current leakage.
- **Trickle Charge** maintains battery charge.
- **World Voltage Switch Adapter**
- **Battery Refresh** reduces memory effect and enables full discharge for long battery life.
- **Car Plug Adapter**
- **Pulse Charging Technology** for fast, efficient charging.
- **Easy To Read LCD Display** shows Charging Progress, Defective Battery, Battery Refresh Features.



CHARGING TIMES

Type of Battery	Charging Times (Appr.)
Ni-MH AA 2700 mAh	80min
Ni-MH AA 2000 mAh	60min
Ni-MH AA 1500 mAh	50min
Ni-MH AAA800 mAh	70min

AVAILABLE COLORS

 Silver

BARCODE

BC-0907



4 260033 157706

PACKAGING



Blister	
Plug:	TUV
Weight(g)	336
Dimensions (W) x (H) x (D) (mm)	125 x 205 x 67
Inner Carton	
Packs / Inner ctn	8
Net Weight(kg)	2.7
Gross Weight(kg)	3.25
Dimensions (L)x (W) x (H) (cm)	53 x 27 x 19
Outer Carton	
Packs / Carton	16
Net Weight(kg)	5.4
Gross Weight(kg)	7
Dimensions (L)x (W) x (H) (cm)	54.5 x 28.5 x 40.5
Volume(M ³)	0.0629

> Super Fast Chargers

It charges most batteries in 1 to 4 hours. They also offer multiple levels of safety protection and many convenient features, such as LED displays and worldwide use plugs.

BC-1007

Charges:

1-4 x 

1-4 x 

Ni-MH



AC Cable



SPECIFICATIONS

Input: 100-240V ~ 50/60Hz

Output: AA 1000 mA (1-2 pcs); 500 mA (3-4 pcs)

AAA 600 mA (1-2 pcs); 300 mA (3-4 pcs)

MAIN FEATURES

- Charges 1-4 AA/AAA Ni-MH /Ni-Cd Batteries
- 6 Levels Charge Protection
 - -ΔV Cut Off
 - Over Temperature Protection
 - Timer Control Protection 3.5 hours (1-2 cells) or 7 hours (3-4 cells)
 - Reverse Polarity Protection
 - Over-current and Short Circuit Protection
 - Defective and Non-rechargeable Battery Detection

- Low Battery Current Leakage
- Worldwide Use AC
100-240V~50/60Hz
- LED Indicators

Red	Charging
Red LED Flashing	Defective / Non-rechargeable Battery/ Short circuit
Green	Fully charged/Trickle

CHARGING TIMES

Type of Battery	Charging Times (Appr.)	
	1-2 Cells	3-4 Cells
Ni-MH AA 2700 mAh	3 h	6 h
Ni-MH AA 2000 mAh	2.5 h	4.5 h
Ni-MH AA 1500 mAh	2 h	3.5 h
Ni-MH AAA 800 mAh	100 min	3 h

AVAILABLE COLORS

 White

BARCODE

BC-1007





PACKAGING



Blister	
Plug:	TUV
Weight(g)	206.5
Dimensions (W) x (H) x (D) (mm)	125 x 205 x 87
Inner Carton	
Packs / Inner ctn	16
Net Weight(kg)	2.3
Gross Weight(kg)	3.8
Dimensions (L)x (W) x (H) (cm)	46 x 25.5 x 27
Outer Carton	
Packs / Carton	32
Net Weight(kg)	6.45
Gross Weight(kg)	8
Dimensions (L)x (W) x (H) (cm)	53 x 47.5 x 29
Volume(M ³)	0.0730

BC-0903

Charges:

2 or 4 x  AA
2 or 4 x  AAA

Ni-MH



AC Adapter



USB



Car Adapter



SPECIFICATIONS

AC To DC Adapter

Input: 100-240V ~ 50/60Hz

Output : 12V $\overline{\overline{=}}$

Car plug

Output : 12V $\overline{\overline{=}}$

USB

Output : 5V $\overline{\overline{=}}$

Charging Currents

12V DC Input

2 x (2.8V $\overline{\overline{=}}$ 900 mA) AA Size

2 x (2.8V $\overline{\overline{=}}$ 500 mA) AAA Size

5V DC Input

2 x (2.8V $\overline{\overline{=}}$ 500 mA) AA Size

2 x (2.8V $\overline{\overline{=}}$ 300 mA) AAA Size

MAIN FEATURES

- 2 Independent Charging Channels
- 6 Levels Charge Protection
 - Δ V Cut-Off
 - Timer Control Protection
 - Over Temperature Protection
 - Reverse Polarity Protection
 - Over Current and Short Circuit Protection
 - Defective and Non-rechargeable Battery Detection

- Low Battery Leakage Current
- Trickle Charge
- Car Plug Adapter and USB Port
- LED Indicators

Red	Charging
Flashing	Defective / Non-rechargeable battery/ Short circuit
Green	Fully charged/trickle

CHARGING TIMES

Type of Battery	Charging Times (Appr.)	
	Input 12V	Input 5V
Ni-MH AA 2700 mAh	3.0 h	6.0 h
Ni-MH AA 2000 mAh	2.7 h	4.8 h
Ni-MH AA 1500 mAh	2.0 h	3.6 h
Ni-MH AAA 800 mAh	1.9 h	3.2 h

AVAILABLE COLORS

 Silver

BARCODE

BC-0903-TUV-4H27-SL(D)



PACKAGING



Blister	
Plug:	TUV
Weight(g)	230
Dimensions (W) x (H) x (D) (mm)	125 x 205 x 67
Inner Carton	
Packs / Inner ctn	8
Net Weight(kg)	1.85
Gross Weight(kg)	2.4
Dimensions (L)x (W) x (H) (cm)	49 x 22.5 x 19
Outer Carton	
Packs / Carton	16
Net Weight(kg)	3.7
Gross Weight(kg)	8.5
Dimensions (L)x (W) x (H) (cm)	49.5 x 47 x 21
Volume(M ³)	0.0491

> Fast Chargers

Charge most batteries in 4 to 8 hours. Packed with features, they are handy around the home, at the office and even when traveling.

BC-1002A

Charges:

2 or 4 × 

2 or 4 × 

Ni-MH



AC Cable



SPECIFICATIONS

Input: 100-240V ~ 50/60Hz

Output: 2 x (2.8V \approx 300mA) AA Size

2 x (2.8V \approx 150mA) AAA Size

MAIN FEATURES

- 2 Independent Charging Channels
- Timer Control (8 hours)
- Over Temperature Protection
- Worldwide Use
- Reverse Polarity Protection
- LED Indicators

ON	Charging
OFF	Fully charged

CHARGING TIMES

Type of Battery	Charging Times (Appr.)
Ni-MH AA 2500 mAh	8 h
Ni-MH AA 2000 mAh	8 h
Ni-MH AA 1500 mAh	6 h
Ni-MH AAA 800 mAh	8 h

AVAILABLE COLORS

 silver

BARCODE

BC-1002A



PACKAGING



Blister	
Plug:	TUV
Weight(g)	118
Dimensions (W) x (H) x (D) (mm)	125 x 205 x 85
Inner Carton	
Packs / Inner ctn	16
Net Weight(kg)	1.89
Gross Weight(kg)	3.42
Dimensions (L)x (W) x (H) (cm)	46 x 24.5 x 27
Outer Carton	
Packs / Carton	32
Net Weight(kg)	3.8
Gross Weight(kg)	7.53
Dimensions (L)x (W) x (H) (cm)	51 x 47.5 x 29
Volume(M ³)	0.0703

BC-1012

Charges:

- 1- 4 × AA
- 1- 4 × AAA

Ni-MH



SPECIFICATIONS

Input: 100-240V ~ 50/60Hz

Output: 1.4V $\overline{\text{---}}$

AA : 400 mA (1~2 Pcs) ; 260 mA (3 Pcs) ; 200 mA (4 Pcs)

AAA : 200 mA (1~2 Pcs) ; 130 mA (3 Pcs) ; 100 mA (4 Pcs)

MAIN FEATURES

- **Charges up to 4 AA/AAA Ni-MH/Ni-Cd Batteries**
- **Multi-band LCD Monitor** for easy to read status of the charger
- **4 Independent Charging Channels** Four charging slots support any AA/AAA battery combination.
- **Reverse Polarity Protection** A special shell structure prevents incorrect battery insertion, helping avoid damage to the battery and charger.
- **Pulse Charging Technology** Uses a precisely regulated current to maximize the charging efficiency, control battery temperature and increase battery life.
- **Micro Control Unit (MCU)** The MCU enables intelligent charging by automatically identifying non-rechargeable batteries, offering multiple levels of protection including negative delta V(- Δ V), voltage protection, safety charging cut-offs.
- **Over Current Protection** Charger maintains a constant charging current during the charging cycle.
- **Short Circuit Protection** The MCU detects attempts to charge shorted batteries or directly short the output channels, in which case the LCD indicator flashes.
- **Timer Control** The charger automatically detects the correct charging time, cuts off the charger automatically(1-2 batteries 6 hours), (3 batteries 9 hours), (4 batteries 12 hours).

CHARGING TIMES

Type of Battery	Charging Times (Appr.)		
	1-2 Akkus	3 Akkus	4 Akkus
Ni-MH AA 2500 mAh	6 h	9 h	12 h
Ni-MH AA 2000 mAh	6 h	9 h	12 h
Ni-MH AAA 1000 mAh	6 h	9 h	12 h
Ni-MH AAA 800 mAh	5 h	8.5 h	11 h

AVAILABLE COLORS

white

BARCODE

BC-1012-2H23AR/2H800AR-DB



4 260216 453199

PACKAGING



Blister	
Plug:	TUV
Weight(g)	118.2
Dimensions (W) x (H) x (D) (mm)	125 x 205x 75
Inner Carton	
Packs / Inner ctn	8
Net Weight(kg)	0.95
Gross Weight(kg)	1.3
Dimensions (L)x (W) x (H) (cm)	49.5 x 23.5 x 14
Outer Carton	
Packs / Carton	32
Net Weight(kg)	3.78
Gross Weight(kg)	5.5
Dimensions (L)x (W) x (H) (cm)	50.5 x 48.5 x 30
Volume(M ³)	0.0735

> Overnight Chargers

These Standard battery chargers are ideal for travel, conventional household or office use. Some are also powered by USB ports.

BC-1001A

Charges:

1-2 x AA

1-2 x AAA

1 x 9V

Ni-MH



SPECIFICATIONS

Input: 100-240V ~ 50/60Hz

Output: 2 x (1.4V = 200 mA) AA/AAA Size

1 x (9V = 25 mA) 9V Size

MAIN FEATURES

- 3 Independent Charging Channels
- 12 Hours Timer Control
- Reverse Polarity Protection
- Slim and Portable
- Built-in Switching Adaptor for Worldwide Use
- LED Indicators

Red	Charging
Off	Fully charged

CHARGING TIMES

Type of Battery	Charging Times (Appr.)
Ni-MH AA 2700 mAh	12 h
Ni-MH AA 2000 mAh	12 h
Ni-MH AA 1500 mAh	10.5 h
Ni-MH AAA 800 mAh	5 h
Ni-MH 9V 200 mAh	9.5 h

AVAILABLE COLORS

 Titanium

BARCODE

BC-1001A



PACKAGING



Blister	
Plug:	TUV
Weight(g)	62
Dimensions (W) x (H) x (D) (mm)	87 x 172 x 50
Inner Carton	
Packs / Inner ctn	32
Net Weight(kg)	1.98
Gross Weight(kg)	2.42
Dimensions (L)x (W) x (H) (cm)	39.5 x 37.5 x 18
Outer Carton	
Packs / Carton	64
Net Weight(kg)	4.0
Gross Weight(kg)	7.5
Dimensions (L)x (W) x (H) (cm)	41 x 39 x 39
Volume(M ³)	0.0624

BC-0904S

Charges:

2 or 4 x AA

2 or 4 x AAA

1-2 x 9V

Ni-MH



SPECIFICATIONS

Input: 230V ~ 50Hz
 Output: 2 x (2.8V = 160 mA) AA size
 2 x (2.8V = 80 mA) AAA size
 2 x (9V = 25 mA) 9V size

MAIN FEATURES

- 2 independent Charging Channels
- Low Charge Current for Longer Battery Life
- Reverse Polarity Protection
- LED Indicators

Red	Charging or charge complete
-----	-----------------------------

CHARGING TIMES

Type of Battery	Charging Times (Appr.)
Ni-MH AA 2000 mAh	17 h
Ni-MH AA 1500 mAh	13 h
Ni-MH AAA 800 mAh	14 h
Ni-MH 9V 200 mAh	9.5 h

AVAILABLE COLORS

 titanium

BARCODE



PACKAGING



Blister	
Plug:	TUV
Weight(g)	274
Dimensions (W) x (H) x (D) (mm)	210 x 130 x 84
Inner Carton	
Packs / Inner ctn	4
Net Weight(kg)	1.1
Gross Weight(kg)	1.3
Dimensions (L)x (W) x (H) (cm)	49.5 x 9 x 21.5
Outer Carton	
Packs / Carton	16
Net Weight(kg)	4.4
Gross Weight(kg)	7.5
Dimensions (L)x (W) x (H) (cm)	51 x 39 x 23.5
Volume(M³)	0.0467

BC-0901

Charges:

1-2 x 
 1-2 x 

Ni-MH



SPECIFICATIONS

Input: 100-240V ~ 50/60Hz 3W Max.
 Output: 2 x (1.4V = 150mA) AA/AAA size

MAIN FEATURES

- 2 Independent Channels
- Reverse Polarity Protection

- LED Indicators

Red	Charging or charge complete
-----	-----------------------------

CHARGING TIMES

Type of Battery	Charging Times (Appr.)
Ni-MH AA 2000 mAh	19 h
Ni-MH AA 1800 mAh	17 h
Ni-MH AAA 800 mAh	8 h

AVAILABLE COLORS

 Silver

BARCODE



PACKAGING



Blister	
Plug:	TUV
Weight(g)	155
Dimensions (W) x (H) x (D) (mm)	125 x 205 x 80
Inner Carton	
Packs / Inner ctn	16
Net Weight(kg)	2.48
Gross Weight(kg)	2.73
Dimensions (L)x (W) x (H) (cm)	39.5 x 23.5 x 12.5
Outer Carton	
Packs / Carton	32
Net Weight(kg)	4.96
Gross Weight(kg)	7.2
Dimensions (L)x (W) x (H) (cm)	48.5 x 41 x 27
Volume(M ³)	0.0537

> Universal Chargers

These can recharge many types of batteries and are perfect for high battery usage households. They are reliable and safe and can even test your batteries to see if its time for a recharge.

CM9398GS

Charges:

1- 4 AA / AAA / D / C or 1-2 9V
Ni-MH Batteries



SPECIFICATIONS

Input: 230V ~ 50Hz

Output: 4 x (1.4V \approx 250mA) D/C/AA/AAA Size
2 x (9V \approx 13mA) 9V Size

MAIN FEATURES

- 4-channel for AAA, AA, C, D ,and 2-channel for 9V batteries.
- The build-in battery change in tester.
- The timer can be selected, based on different capacity.
- Trickle charge function.
- Overcharge Protection Function.

CHARGING TIMES

Type of Battery	Charging Times (Appr.)
Ni-MH D 2500 mAh	24 h
Ni-MH C 3500 mAh	24 h
Ni-MH AA 2500 mAh	24 h
Ni-MH AAA 900 mAh	6 h
Ni-MH 9V 200 mAh	20 h

AVAILABLE COLORS

 Black

BARCODE



PACKAGING



Blister	
Weight(g)	680
Dimensions (W) x (H) x (D) (mm)	330 x 175 x 60
Inner Carton	
Packs / Inner ctn	10
Gross Weight(kg)	7.32
Dimensions (L)x (W) x (H) (cm)	59 x 23.5 x 19.5
Outer Carton	
Packs / Carton	20
Net Weight(kg)	13.7
Gross Weight(kg)	16.0
Dimensions (L)x (W) x (H) (cm)	62 x 36 x 46
Volume(M ³)	0.10

CM3298

Charges:

1 - 4 C / D + 1 - 2 9V
 1 - 6 AA / AAA + 1 - 2 9V
 Ni-MH Batteries



SPECIFICATIONS

Input: AC 100 ~ 240V 50Hz/60Hz 30W
 Charging Current: 4 x C, D / DC 1.2V approx. 1,000mA
 6 x AAA / DC 1.2V approx. 500mA
 6 x AA / DC 1.2V approx. 1,000mA
 2 x DC 9V approx. 70mA
 USB 5V: approx. 500mA max.

MAIN FEATURES

- **8 Independent Charging Channels**
- **LCD Display** Shows the charging status of each individual Battery
- **6 Level Charge Protection**
 - Δ V Cut-Off
 - Timer Control Protection (10 hours)
 - Over Temperature Protection
 - Reverse Polarity Protection
 - Over Current and Short Circuit Protection
 - Defective and Non-rechargeable battery Detection
- **USB Port**
Enables you to charge external devices such as MP3 players or mobile phones
- **Trickle Charge**
- **Discharge Function**
9V battery can not be discharged
- **Battery Refresh Function**
- **World Voltage Switch Adapter**
- **LED Indicators**

Display	LED	Explanation
		The LED continuously glows green: Full charged
		The LED blinks alternately red and green: The batteries are being discharged for max. 10 minutes. (Refresh Function)
		The LED continuously glows red: Charging: The batteries are being charged
		Loading error: The LED blinks red: The inserted batteries are not positioned correctly in the charging slot or are defective.
		Check / Precharge: The LED blinks green: precharge / Check the batteries

CHARGING TIMES

Type of Battery	Charging Times (Appr.)
Ni-MH AA 2500 mAh	3.5 h
Ni-MH AAA 900 mAh	2.5 h
Ni-MH C 4000 mAh	5.5 h
Ni-MH D 4500 mAh	6.2 h
Ni-MH 9V 200 mAh	4.0 h

AVAILABLE COLORS

Silver

BARCODE



PACKAGING



Box	
Plug:	TUV
Weight(g)	660
Dimensions (W) x (H) x (D) (mm)	241.5 x 60 x 215
Outer Carton	
Packs / Carton	10
Net Weight(kg)	6.6
Gross Weight(kg)	7.3
Dimensions (L) x (W) x (H) (cm)	32 x 44.5 x 24
Volume(M ³)	0.0341

LBC-312

Charges:

Most 1.2V 3.7V or 7.4V Batteries*

Li-ion

Ni-MH



Includes:



AC Cable



SPECIFICATIONS

Charger

Input: 100-240V ~ 50/60Hz 12W Max

Charging current:

Lithium batteries: 3.6/3.7V 0.8A (Max)
7.2/7.4V 0.6A (Max)

Ni-MH/Ni-Cd: 2 x 1.4V = 0.7A (Max)

USB output: 5V = 0.5A

MAIN FEATURES

- **Supports Many Devices** Compatible with almost all 3.7V and 7.4V Li-ion, 1.2V Ni-MH and Ni-Cd batteries for such devices as digital cameras, Camcorders, mobile phones, MP3 /MP4 players, game players and more.
- **Automatic Voltage/Polarity Selection** Microprocessor core identifies battery type and +/- polarity, making it easy for you to use.
- **Safe** Faulty battery detection; 5 hours safety timer for Ni-MH/Cd and 10 hours safety timer for Li-ion.
- **Convenient Design**
- **Portable** Lightweight design and worldwide voltage input and adapter plugs for easy traveling.
- **USB output port** for iPhone, iPod, Andriod Smartphone, MP3, MP4 GPS devices and more.

LED Indicator

CONDITIONS	CHARGING (green)	POWER (red)
No power or faulty power supply	Off	Off
Power on	Off	On
Battery charging	Flashing	On
Fully charged	On	On
Faulty battery or charging process stopped by 5/10h safety timer	Flashing	Flashing

CHARGING TIMES

Battery Capacity	Charging Times
Ni-MH AA 2700 mAh	4.5 h
Ni-MH AA 2000 mAh	4.0 h
Ni-MH AA 1500 mAh	2.5 h
Ni-MH AAA 800 mAh	90 min

AVAILABLE COLORS

Black

BARCODE

LBC-312



4 260216 452994

PACKAGING



Blister	
Plug:	TUV
Weight(g)	179
Dimensions (W) x (H) x (D) (mm)	185 x 128 x 70
Inner Carton	
Packs / Inner ctn	10
Net Weight(kg)	1.79
Gross Weight(kg)	2.14
Dimensions (L)x (W) x (H) (cm)	56.5 x 20.6 x 13.5
Outer Carton	
Packs / Carton	40
Net Weight(kg)	7.16
Gross Weight(kg)	10.6
Dimensions (L)x (W) x (H) (cm)	58 x 42.7 x 29
Volume(M ³)	0.0719

Battery Charging Table

Directions:

The following table lists out charging times for specific Camelion chargers and batteries.

For example, to find the charging time for the BC-0907 charger using a Nickel Metal Hydride AA2500mah battery, first locate the BC-0907 column. Then locate the AA2500mah row. Finally, the point of intersection indicates the value, which is 80min.

Camelion Model	BC-0907	BC-1007		BC-0903		BC-0901	BC-1002A	BC-1001A
	DC in 12V, 1.5A	1-2 cells	3-4 cells	DC in 12V,1A	DC in 5V,1A			
Timer Control	1.5h	NA	NA	3.0h	6.0h	NA	8h	Voltage Cut Off
Ni-MH Batteries								
NH-D2500	NA	3h	NA	NA	NA	NA	NA	NA
NH-C2500	NA	3h	NA	NA	NA	NA	NA	NA
NH-AA2700	80min	3h	6h	T/C 3.0h	T/C 5.9h	23.0h	T/C 8h	T/C 12h
NH-AA2600	80min	3h	5.5h	T/C 3.0h	T/C 5.6h	22.0h	T/C 8h	T/C 12h
NH-AA2500	80min	2.5h	5.5h	T/C 3.0h	5.5h	22.0h	T/C 8h	T/C 12h
NH-AA2300	70min	2.5h	5.5h	3.0h	5.5h	21.0h	T/C 8h	T/C 12h
NH-AA2200	70min	2h	5h	2.9h	5.3h	20.0h	T/C 8h	T/C 12h
NH-AA2000	60min	2h	4.5h	2.7h	4.8h	19.0h	T/C 8h	T/C 12h
NH-AA1800	60min	2h	4.5h	2.4h	4.3h	17.0h	T/C 8h	T/C 12h
NH-AA1500	50min	2h	3.5h	2.0h	3.6h	14.0h	6h	10.5h
NH-AAA1100	90min	100min	4h	2.3h	3.8h	9.0h	T/C 8h	6h
NH-AAA1000	80min	100min	3.5h	2.0h	3.4h	9.0h	T/C 8h	5.5h
NH-AAA900	80min	70min	3.5h	1.9h	3.2h	8.0h	T/C 8h	5h
NH-AAA800	70min	NA	3h	1.9h	3.2h	8.0h	T/C 8h	5h
NH-AAA600	60min	NA	2.5h	1.4h	2.4h	5.0h	5h	3.5h
NH-9V250	NA	NA	NA	NA	NA	NA	NA	11h
NH-9V200	NA	NA	NA	NA	NA	NA	NA	9.5h

Camelion Model	BC-1012			BC-0904S	CM-9398GS	CM3298	LBC-312
	1-2 cells	3 cells	4 cells				
Timer Control	6.0h	9.0h	12h	NA	3 / 6 / 9 / 24h	10h	5h
Ni-MH Batteries							
NH-D2500	NA	NA	NA	NA	14h	3h	NA
NH-C2500	NA	NA	NA	NA	14h	3h	NA
NH-AA2700	T/C 6h	T/C 9h	T/C 12h	22h	14h	3h	4.5h
NH-AA2600	T/C 6h	T/C 9h	T/C 12h	20h	13h	3h	4h
NH-AA2500	T/C 6h	T/C 9h	T/C 12h	20h	13h	3h	4h
NH-AA2300	T/C 6h	T/C 9h	T/C 12h	19h	12h	2.5h	4h
NH-AA2200	T/C 6h	T/C 9h	T/C 12h	19h	12h	2.5h	3.5h
NH-AA2000	T/C 6h	T/C 9h	T/C 12h	17h	10.5h	2.5h	3.5h
NH-AA1800	6h	T/C 9h	T/C 12h	16h	10h	2h	3h
NH-AA1500	4.5h	7h	10.5h	13h	8.5h	2h	2.5h
NH-AAA1100	T/C 6h	T/C 9h	T/C 12h	17h	4.5h	2.5h	100min
NH-AAA1000	T/C 6h	T/C 9h	T/C 12h	16h	4.5h	2h	100min
NH-AAA900	5h	T/C 9h	12h	15h	3.5h	2h	90min
NH-AAA800	5h	8.5h	11h	14h	3.5h	2h	90min
NH-AAA600	3.5h	5.5h	7h	10.5h	3h	1.5h	1h
NH-9V250	NA	NA	NA	11h	11h	4.5h	NA
NH-9V200	NA	NA	NA	9.5h	9.5h	3.5h	NA

Notes:

NA - Not Applicable.

T/C: Charger has timer control. This is the cut off time, whether the battery is fully charged or not..

All the data is based on Camelion latest lab tests. Charging times may vary based upon temperature, product age, voltage and other conditions. This data sheet is for customer reference purposes only and to help customers choose the appropriate product. Contents do not constitute a warranty.

For information on specific Camelion products please visit our website at www.camelionbattery.com or contact us directly at info@camelionbattery.com.

Power Supplies



> Power Banks

Camelion Power Banks offers you fast, easy and reliable power source for your mobile devices. Integrated with top quality battery cells, we ensure you a product of long life and fully compliant with international safety standards

Camelion®

PS671



PS671-DB



Accessory:
USB Cable
(L:30cm)



LED Status (● ON ○ OFF)	Capacity
● ● ● ●	76%-100%
○ ● ● ●	51%-75%
○ ○ ● ●	26%-50%
○ ○ ○ ●	<25%

Main Features

- 3D printed surface design
- Dual USB output ports
- Compatible with most mobile devices
- Short circuit, over discharge, overcharge and over current protections

Specifications

Battery Capacity: 6000mAh Li-polymer battery
Power Input: Micro USB 5V $\bar{\bar{}}$ 1.5A
Power Output: 5V $\bar{\bar{}}$ 2.1A(1+1A)

Packaging

Blister	Weight(g)	180
	Dimensions (W) x (H) x (D)(mm)	135 x 230 x 36
Inner Carton	Packs / Inner ctn	/
	Net Weight(kg)	/
	Gross Weight(kg)	/
	Dimensions (L)x (W) x (H) (cm)	/
Outer Carton	Packs / Carton	48
	Net Weight(kg)	/
	Gross Weight(kg)	/
	Dimensions (L)x (W) x (H) (cm)	55 x 44.5 x 25.5
	Volume(cbm)	0.0625

PS674



PS674-DB



Accessory:
USB Cable
(L:30cm)



LED Status (● ON ○ OFF)	Capacity
● ● ● ●	76%-100%
○ ● ● ●	51%-75%
○ ○ ● ●	26%-50%
○ ○ ○ ●	<25%

Main Features

- 3D printed surface design
- 2.1A output
- Compatible with most mobile devices
- Short circuit, over discharge, overcharge and over current protections

Specifications

Battery Capacity: 10000mAh Li-polymer battery
Power Input: Micro USB 5V $\bar{\bar{}}$ 2A
Power Output: 5V $\bar{\bar{}}$ 2.1A

Packaging

Blister	Weight(g)	260
	Dimensions (W) x (H) x (D)(mm)	135 x 230 x 39
Inner Carton	Packs / Inner ctn	/
	Net Weight(kg)	/
	Gross Weight(kg)	/
	Dimensions (L)x (W) x (H) (cm)	/
Outer Carton	Packs / Carton	48
	Net Weight(kg)	12.48
	Gross Weight(kg)	13.28
	Dimensions (L)x (W) x (H) (cm)	55 x 46.5 x 25.5
	Volume(cbm)	0.0653

PS660



PS660-DB



LED Status (● ON ○ OFF)	Capacity
● ● ● ●	80%-100%
○ ● ● ●	40%-80%
○ ○ ● ●	20%-40%
○ ○ ○ ●	<20%

Main Features

- Compatible with most mobile devices
- Auto on/off capability
- Pre-charged & Ready to use
- LED power indicator
- Over-charge, Over-discharge, Over-current, Short circuit protection

Specifications

Battery Capacity: 4000mAh Li-polymer battery
Power Input: Micro USB 5V $\bar{\bar{}}$ 1A
Power Output: 5V $\bar{\bar{}}$ 2A

Packaging

Blister	Weight(g)	100
	Dimensions (W) x (H) x (D)(mm)	133x220x20
Inner Carton	Packs / Inner ctn	/
	Net Weight(kg)	/
	Gross Weight(kg)	/
	Dimensions (L)x (W) x (H) (cm)	/
Outer Carton	Packs / Carton	48
	Net Weight(kg)	4.8
	Gross Weight(kg)	5.3
	Dimensions (L)x (W) x (H) (cm)	42.5 x 39.5 x 24.5
	Volume(cbm)	0.0412

PS661



Main Features

- Compatible with most mobile devices
- Auto on/off capability
- Pre-charged & Ready to use
- LED power indicator
- Over-charge, Over-discharge, Over-current, Short circuit protection
- Dual USB output

Specifications

Battery Capacity: 10400mAh Lithium-ion 18650
Power Input: Micro USB 5V \pm 2A
Power Output: 5V \pm 3.4A(2.4+1A)



PS661-DB



Accessory:
USB Cable
(L:30cm)



LED Status (● ON ○ OFF)	Capacity
● ● ● ●	80%-100%
○ ● ● ●	40%-80%
○ ○ ● ●	20%-40%
○ ○ ○ ●	<20%

Packaging

Blister	Weight(g)	/
	Dimensions (W) x (H) x (D)(mm)	135 x 230 x 35
Inner Carton	Packs / Inner ctn	/
	Net Weight(kg)	/
	Gross Weight(kg)	/
	Dimensions (L)x (W) x (H) (cm)	/
Outer Carton	Packs / Carton	48
	Net Weight(kg)	13
	Gross Weight(kg)	14
	Dimensions (L)x (W) x (H) (cm)	55 x 44 x 25.5
	Volume(cbm)	0.0617

PS638



Main Features

- Compatible with most mobile devices
- Pre-charged & Ready to use
- LED power indicator
- Over charge & Over discharge & Over current & Short circuit protections

Specifications

Battery Capacity: 4000mAh Li-polymer battery
Power Input: Micro USB 5V \pm 2A
Power Output: 5V \pm 1A

Pouch optional



PS638-PE-DB



Accessory:
USB Cable
(L:30cm)



LED Status (● ON ○ OFF)	Capacity
● ● ● ●	80%-100%
○ ● ● ●	40%-80%
○ ○ ● ●	20%-40%
○ ○ ○ ●	<20%

Packaging

Blister	Weight(g)	204
	Dimensions (W) x (H) x (D)(mm)	135 x 230 x 35
Inner Carton	Packs / Inner ctn	/
	Net Weight(kg)	/
	Gross Weight(kg)	/
	Dimensions (L)x (W) x (H) (cm)	/
Outer Carton	Packs / Carton	48
	Net Weight(kg)	9.7
	Gross Weight(kg)	11.1
	Dimensions (L)x (W) x (H) (cm)	55 x 44 x 25.5
	Volume(cbm)	0.0617

PS639



Main Features

- Compatible with most mobile devices
- Dual USB output
- Pre-charged & Ready to use
- LED power indicator
- Over charge & Over discharge & Over current & Short circuit protections

Specifications

Battery Capacity: 10000mAh Li-polymer battery
Power Input: Micro USB 5V \pm 2A
Power Output: 5V \pm 3.4A(2.4A+1A)



PS639-DB



Accessory:
USB Cable
(L:30cm)



LED Status (● ON ○ OFF)	Capacity
● ● ● ●	80%-100%
○ ● ● ●	40%-80%
○ ○ ● ●	20%-40%
○ ○ ○ ●	<20%

Packaging

Blister	Weight(g)	316
	Dimensions (W) x (H) x (D)(mm)	135 x 230 x 35
Inner Carton	Packs / Inner ctn	/
	Net Weight(kg)	/
	Gross Weight(kg)	/
	Dimensions (L)x (W) x (H) (cm)	/
Outer Carton	Packs / Carton	40
	Net Weight(kg)	12.6
	Gross Weight(kg)	14
	Dimensions (L)x (W) x (H) (cm)	55 x 37 x 25.5
	Volume(cbm)	0.0519

USB Power Adapters

Camelion USB Power Adapters offers you fast, reliable and efficient charging at home, office or during your travels. It comes in different sizes and all works with universal voltage, providing you the convenience of charging your mobile devices wherever you go.

Camelion®

AD568

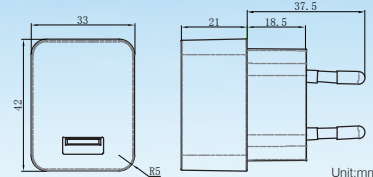

AD568-DB



Main Features

- 1A direct power source for mobile devices
- Use any cable with charger
- Over current, overheating and short circuit protections
- Universal voltage

Specifications

Input: 100-240V~50/60Hz 150mA Max
Output: 5V 1A

Packaging

Blister	Plug:	TUV	UL
	Weight(g)	77	68
Dimensions (W) x (H) x (D)(mm)		107x171x64	107 x 171 x 64
Inner Carton	Packs / Inner ctn	12	12
	Net Weight(kg)	0.78	0.67
	Gross Weight(kg)	0.95	0.84
	Dimensions (L)x (W) x (H) (cm)	42.4 x 20.1 x 11.4	42.4 x 20.1 x 11.4
Outer Carton	Packs / Carton	48	48
	Net Weight(kg)	3.13	2.69
	Gross Weight(kg)	4.53	3.98
	Dimensions (L)x (W) x (H) (cm)	43.5 x 41.8 x 24.8	43.5 x 41.8 x 24.8
	Volume(cbm)	0.0451	0.0635

AD569

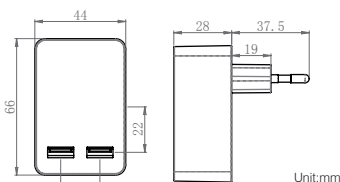

AD569-DB



Main Features

- 3.4A output USB port for fastest possible charging
- Dual USB output
- Direct power source for tablets and mobile devices
- Use any cable with charger
- Over current, overheating and short circuit protections
- Universal voltage

Specifications

Input: 100-240V~50/60Hz 430mA Max
Output: 5V 3.4A (2.4A+1A)

Packaging

Blister	Plug:	TUV	UL
	Weight(g)	123	114
Dimensions (W) x (H) x (D)(mm)		107 x 171 x 73	107 x 171 x 73
Inner Carton	Packs / Inner ctn	12	12
	Net Weight(kg)	1.48	1.38
	Gross Weight(kg)	1.65	1.55
	Dimensions (L)x (W) x (H) (cm)	47.5 x 21 x 11.4	47.5 x 21 x 11.4
Outer Carton	Packs / Carton	48	48
	Net Weight(kg)	5.9	5.5
	Gross Weight(kg)	7.8	7.4
	Dimensions (L)x (W) x (H) (cm)	49 x 43.5 x 24.8	49 x 43.5 x 24.8
	Volume(cbm)	0.0529	0.0697

AD570

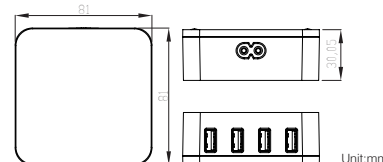

AD570-DB



Main Features

- 6.8A output USB port for fastest possible charge
- Four USB output to charge 4 devices simultaneously
- Over current, overheating and short circuit protections
- Universal voltage

Specifications

Input:100-240V~50/60Hz 1A Max
Output: 5V 6.8A (2.4A+2.4A+1A+1A)

Packaging

Blister	Plug:	UL/UK/TUV/SAA
	Weight(g)	244
Dimensions (W) x (H) x (D)(mm)		139 x 221 x 83
Inner Carton	Packs / Inner ctn	18
	Net Weight(kg)	/
	Gross Weight(kg)	/
	Dimensions (L)x (W) x (H) (cm)	40.5 x 36 x 22.5
Outer Carton	Packs / Carton	36
	Net Weight(kg)	8.8
	Gross Weight(kg)	9.8
	Dimensions (L)x (W) x (H) (cm)	42.3 x 37.8 x 47
	Volume(cbm)	0.0752

DD801

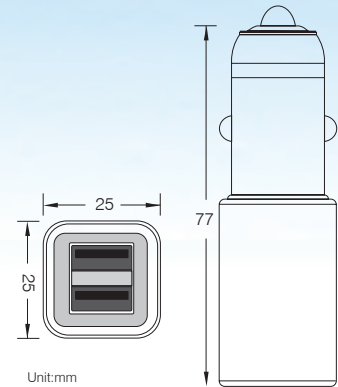

Main Features

- **Car Charger with Dual USB Port** Up to 5V, 2100mA direct power sources for iPad, iPod units, iPhone, mobile phones, PSP, Blackberry, Digital cameras and other music players and devices. Just plug it in to your car cigarette or plug into electric socket, power up and start to play.
- **Short Circuit Protection** Damage to the charger and mobile device is prevented in case of a short circuit.

Specifications

Input: 12 - 24V $\overline{\text{---}}$

Output: 5V $\overline{\text{---}}$ 2.1A using 1USB port
5V $\overline{\text{---}}$ 1A using 2USB ports

Packaging

Blister	Weight(g)	66
	Dimensions (W) x (H) x (D)(mm)	133 x 220 x 69
Inner Carton	Packs / Inner ctn	18
	Dimensions (L)x (W) x (H) (cm)	41.5 x 30 x 23.5
Outer Carton	Packs / Carton	36
	Net Weight(kg)	2.4
	Gross Weight(kg)	3.9
	Dimensions (L)x (W) x (H) (cm)	48.5 x 31.5 x 43.5
	Volume(cbm)	0.0665

DD802

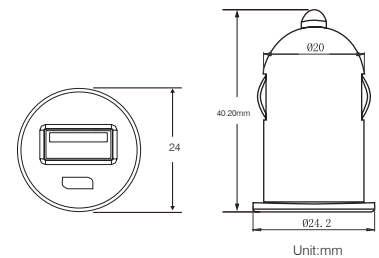

Main Features

- **USB Port For In-Car Power** Just plug it in and play.
- **5V 1A Power Output** Supports a wide range of mobile devices, such as iPhone®, PSP®, and other portable devices.
- **Short Circuit Protection** Reduces the risk of damage to your unit and the adapter in case of a short circuit.

Specifications

Input: 12 - 24V

Power Output: 5V $\overline{\text{---}}$ 1A

Packaging

Blister	Weight(g)	56.3
	Dimensions (W) x (H) x (D)(mm)	112 x 184 x 57
Inner Carton	Packs / Inner ctn	24
	Dimensions (L)x (W) x (H) (cm)	23.1 x 19.1 x 12.4
Outer Carton	Packs / Carton	48
	Net Weight(kg)	2.7
	Gross Weight(kg)	3.9
	Dimensions (L)x (W) x (H) (cm)	39.6 x 24.5 x 40
	Volume(cbm)	0.0388

DD812

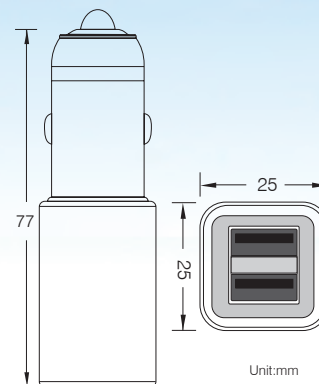

Main Features

- 3.4A USB ports for possible fast charging
- Dual-USB port enable to charge 2 devices at the same time
- Power for tablet, smartphone and other mobile devices
- Over charge and short circuit protections

Specifications

Input: 12V - 24V
Output: 5V 3.4A (2.4A + 1A)

Packaging

Blister	Weight(g)	66
	Dimensions (W) x (H) x (D)(mm)	133 x 220 x 69
Inner Carton	Packs / Inner ctn	18
	Dimensions (L)x (W) x (H) (cm)	41.5 x 30 x 23.5
Outer Carton	Packs / Carton	36
	Net Weight(kg)	2.4
	Gross Weight(kg)	3.9
	Dimensions (L)x (W) x (H) (cm)	48.5 x 31.5 x 43.5
	Volume(cbm)	0.0665

DD823

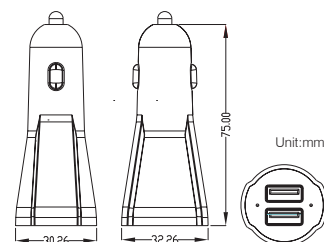

Main Features

- Compatible with most mobile devices
- Dual-USB port design
- Max 2.4 fast charging
- Short circuit protections

Specifications

Input: 12V - 24V
Output: 5V 2.4A+2.4A

Packaging

Blister	Weight(g)	65
	Dimensions (W) x (H) x (D)(mm)	133 x 220 x 35
Inner Carton	Packs / Inner ctn	18
	Dimensions (L)x (W) x (H) (cm)	41.5 x 23.5 x 23.5
Outer Carton	Packs / Carton	36
	Net Weight(kg)	2.4
	Gross Weight(kg)	3.9
	Dimensions (L)x (W) x (H) (cm)	48.5 x 42.5 x 25
	Volume(cbm)	0.0516

Device Chart

BEST YES NO

		Power Banks						USB Power Adapters						
USB Enable Devices		PS660	PS661	PS638	PS639	PS671	PS674	AD568	AD569	AD570	DD801	DD802	DD812	DD823
Mobile & Professional	iPhone 4/4S/5	✓	✓	✓	✓	✓	✓	✓	✓	✓	✓	✓	✓	✓
	iPod®	✓	✓	✓	✓	✓	✓	✓	✓	✓	✓	✓	✓	✓
	iPad®	✓	✓	✓	✓	✓	✓	✓	✓	✓	✓	✓	✓	✓
	Sumsung	✓	✓	✓	✓	✓	✓	✓	✓	✓	✓	✓	✓	✓
	Sony	✓	✓	✓	✓	✓	✓	✓	✓	✓	✓	✓	✓	✓
	HTC	✓	✓	✓	✓	✓	✓	✓	✓	✓	✓	✓	✓	✓
	Blackberry®	✓	✓	✓	✓	✓	✓	✓	✓	✓	✓	✓	✓	✓
	Nokia	✓	✓	✓	✓	✓	✓	✓	✓	✓	✓	✓	✓	✓
	LG	✓	✓	✓	✓	✓	✓	✓	✓	✓	✓	✓	✓	✓
	Sharp	✓	✓	✓	✓	✓	✓	✓	✓	✓	✓	✓	✓	✓
	Motorola	✓	✓	✓	✓	✓	✓	✓	✓	✓	✓	✓	✓	✓
	Smart Phone	✓	✓	✓	✓	✓	✓	✓	✓	✓	✓	✓	✓	✓
	Portable Gaming Devices	✓	✓	✓	✓	✓	✓	✓	✓	✓	✓	✓	✓	✓
	Tablet	✓	✓	✓	✓	✓	✓	✓	✓	✓	✓	✓	✓	✓
Others	MP3/MP4/MP5	✓	✓	✓	✓	✓	✓	✓	✓	✓	✓	✓	✓	✓
	Loudspeaker	✓	✓	✓	✓	✓	✓	✓	✓	✓	✓	✓	✓	✓
	AM/FMRadio	✓	✓	✓	✓	✓	✓	✓	✓	✓	✓	✓	✓	✓
	Digital Camera	✓	✓	✓	✓	✓	✓	✓	✓	✓	✓	✓	✓	✓
	GPS	✓	✓	✓	✓	✓	✓	✓	✓	✓	✓	✓	✓	✓
	USB battery charger	✗	✗	✗	✗	✗	✗	✓	✓	✓	✓	✓	✓	✓
	Electronic shaver	✓	✓	✓	✓	✓	✓	✓	✓	✓	✓	✓	✓	✓

- Remark:**
1. The capacity of the iPad battery must be not less than 5%.
 2. Apply for USB 2.0 or lower version only.
 3. Camelion accepts no responsibility for any accidents resulting from use of this information.

Flashlights & Lanterns

TRAVLite™ Flashlights

ideal Lighting for Out of Doors



LED Pocket Flashlight

- Ultra shock resistant up to 3 meters drop height
- Continuous lighting up to 20 hrs*
- LED light source
- Water resistant (IPX4)**
- Slim portable design

Best for:

Traveling, hiking, camping, fishing and athletics

*Camelion 2015 lab tests, LED brightness will attenuate when battery power is weak.

**An IPX4 designation means it will withstand against rain and jets of water, but it not suitable nor guaranteed to survive for swimming or immerse under water.

*** An IPX7 designation means it can withstand accidental immersion in water within the depth of one meter for up to 30 minutes.



LED Rubber Flashlight

- **Heavy Duty Rubberized Case**
- **Shockproof** up to 2 meters drop
- **Water Resistant** (up to IPX7***)
- **Shatterproof Optical Lens**
- **Non Slip Grip** oil/grease resistant grip with push button switch and end strap
- **Never replace LEDs** 100,000 hr lifetime
- **Brightness Intensifying Optical Cavity Design**

Model#	Specifications						
	LEDs	LED Type	Luminous Flux	Battery Mode	Body Material	Available Colors	Water Resistant (Y/N)
HP7011	1	0.5W LED	45 lm	3 x AAA	Rubber	<div style="display: flex; gap: 5px;"> Red Green </div>	Y
PT1L2D	1	Superbright LED	45 lm	2 x D	Rubber	<div style="display: flex; gap: 5px;"> Red Blue </div>	Y
PT1L2AA	1	Superbright LED	45 lm	2 x AA	Rubber	<div style="display: flex; gap: 5px;"> Red Blue </div>	Y



HP7011

Up to
20 Hrs
Continuous use

CE



HP7011-3R03BP



4 260216 450136



HP7011D24



4 260216 452659

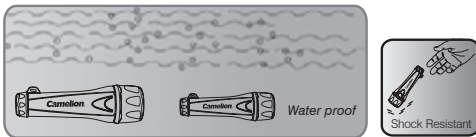

PT1L2D

Up to
140 Hrs
Continuous use

CE



PT1L2D-2R20PBP



4 260216 456381



PT1L2AA

Up to
20 Hrs
Continuous use

CE



PT1L2AA-2R6PBP



4 260216 456374



Packaging Details													
Item#	Packaging Type	Included Batteries	Blister/Box Details					Outer Carton Details					
			Dimensions (mm)			Net Weight (g)	Packs/ Carton	Dimensions (cm)			Volume (M ³)	Gross Weight (Kg)	Net Weight (kg)
			L Length	W Width	D Depth			L Length	W Width	H Height			
HP7011-3R03BP	Blister Pack	3R03P	190	110	40	96.5	48	51.5	21.5	26.5	0.0294	6.4	4.7
HP7011D24	Display Box	—	303	206	110	1496	4	46	34	25	0.0391	7.1	6.0
PT1L2D-2R20PBP	Blister Pack	2 x 2R20P	305	175	70	446	24	50.5	45	33	0.0750	11.7	10.7
PT1L2AA-2R6PBP	Blister Pack	2 x R6P	248	120	50	161	48	49.5	36	33	0.0588	8.7	7.7



LED Lantern

- **Effective Lighting** 360° lighting with light diffuser.
- **LED Technology** The high lumen LED provides outstanding illumination, high energy efficiency, and up to 30,000 hours lifetime.
- **Standby Yellow LED** to save energy costs.
- **Handy** Easy grip, adjustable handle with hook.
- **Durable Construction** Slim with non-topple base.
- **2 Lighting Modes** Night Light and Full Beam lighting modes for different situations.
- **Rubber boot**ed push switch



SL1011



4 260216 452444

Specifications

Product Picture	Name	Model #	LEDs	LED Type	Lumens	Battery Mode	Body Material	Available Colors	Water Resistant
	LED Lantern	SL1011	1	1W LED	70lm	3 x D	Plastic	Green	✗

Packaging Details

Pack. Picture	Name	Item#	Packaging Type	Included Batteries	Blister/Box Details				Outer Carton Details						
					Dimensions (mm)			Net Weight (g)	Packs/ Carton	Dimensions (cm)			Volume (M ³)	Gross Weight (Kg)	Net Weight (kg)
					L Length	W Width	D Depth			L Length	W Width	D Depth			
	LED Lantern	SL1011	Box	—	125	125	205	600	12	43.4	27.2	40.5	0.0478	8.6	7.2

SuperBright™ Flashlights

LED Flashlights for Home or Outdoor Use



Multi-head LED Classic Flashlights

- **Cloverleaf Reflector System** for maximum focus and intensity
- **Energy Saving LEDs** up to 5 times brighter, 8 times more efficient than regular krypton bulbs*
- **Long Service Life** Up to 180 hours continuous lighting*
- **Never Replace LEDs** 100,000h LED lifetime
- **Handy Grip** with hooks, anti-roll design

*Camelion 2009 Lab Tests. Performance subject to battery, temperature and ambient lighting conditions.

Best for:

- Indoor and/or outdoor use
- Handy for camping, travel, fishing
- Household use, walking the dog



6 LED



FL6L2D2R20P



Product Picture	Name	Model #	LEDs	LED Type	Lumens	Battery Mode	Specifications		
							Body Material	Available Colors	Water Resistant
	Multi-Head LED Classic Flashlights	FL6L2D	6	Superbright LED	12lm	2 x D	Plastic		✓

Pack. Picture	Name	Item#	Packaging Type	Included Batteries	Packaging Details										
					Blister/Box Details				Outer Carton Details						
					Dimensions (mm)			Net Weight (g)	Packs/ Carton	Dimensions (cm)			Volume (M ³)	Gross Weight (Kg)	Net Weight (kg)
L Length	W Width	D Depth			L Length	W Width	D Depth								
	Multi-Head LED Classic Flashlights	FL6L2D2R20P	Blister Pack	2 x R20P	264	144	40	285	24	55.5	42.5	18.5	0.0436	8.3	7.4

SuperBright™ Searchlamps

LED Search lamps for Home or Outdoor Use



Multi-head LED Searchlamps

- **Powerful** Lights distances up to 150 meters*
- **Cloverleaf Reflector System** for maximum focus and intensity
- **Energy Saving LEDs** up to 5 times brighter, 8 times more efficient than regular krypton bulbs*
- **Long Service Life** Up to 500 hours continuous lighting*
- **Never Replace LEDs** 100,000h LED lifetime
- **Handy Grip** with hooks, anti-roll design

*Camelion 2009 Lab Tests. Performance subject to battery (alkaline), temperature and ambient lighting conditions.

Best for:

- Indoor and/or outdoor use
- Military, security, campus, factory, emergency kits
- Vehicle use, garages, auto service use
- Handy for camping, travel, fishing

Product Picture	Name	Model #	Specifications						
			LEDs	LED Type	Lumens	Battery Mode	Body Material	Available Colors	Water Resistant
	Multi-Head LED Search lamps	FL-16LED	16	Super Bright LED	32lm	4 x D/ 1 x 4R25	Plastic	Yellow	✓
	Multi-Head LED Search lamps	FL-9LED	9	Super Bright LED	18lm	4 x AA	Plastic	Yellow	✓

FL-16LED

 **16LED**

Up to
500 Hrs
Continuous use



CE

FL-16LED-4R20PCB



FL-9LED

 **9LED**



Up to
150 Hrs
Continuous use



CE

FL-9LED-4R6P



			Packaging Details												
Pack. Picture	Name	Item#	Packaging Type	Included Batteries	Blister/Box Details				Outer Carton Details						
					Dimensions (mm)			Net Weight (g)	Packs/ Carton	Dimensions (cm)			Volume (M ³)	Gross Weight (Kg)	Net Weight (kg)
					L Length	W Width	D Depth			L Length	W Width	D Depth			
	Multi-Head LED Search lamps	FL-16LED-4R20PCB	Box	—	250	123	135	708	12	52	39	30	0.0608	10.6	9.6
	Multi-Head LED Search lamps	FL-9LED-4R6P	Shrink pack	4 x R6P	100	146	110	278	36	59	54	24	0.0765	12.0	10

SuperBright™ Flashlights

Budget Flashlights for Everyday Use









Classic Flashlights

- Super bright and replaceable LED bulb
- 35 lumens of light
- Long battery service life
- Many Color Options

Best for:

- Indoor & outdoor usage
- Household use

			Specifications					
Product Picture	Name	Model #	Bulb Type	Lumens	Battery Mode	Body Material	Available Colors	Water Resistant
	Classic Flashlights	FL1L2D	LED	35lm	2 x D	Plastic	 Red Yellow Blue Black	✗
	Classic Flashlights	FL1L2C	LED	35lm	2 x C	Plastic	 Red Yellow Blue Black	✗
	Classic Flashlights	FL1L2AA	LED	35lm	2 x AA	Plastic	 Red Yellow Blue Black	✗

FL1L2D

 **1 LED**



FL1L2D2R20P



FL1L2DD12

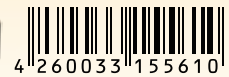

FL1L2C

 **1 LED**



FL1L2C2R14P



FL1L2AA

 **1 LED**







FL1L2AA2R6P



FL1L2AAD24



Packaging Details

Pack. Picture	Name	Item#	Packaging Type	Included Batteries	Blister/Box Details			Outer Carton Details							
					Dimensions (mm)			Net Weight (g)	Packs/ Carton	Dimensions (cm)			Volume (M ³)	Gross Weight (Kg)	Net Weight (kg)
					L Length	W Width	D Depth			L Length	W Width	D Depth			
	Classic Flashlights	FL1L2DB2R20P	Blister Pack	2 x R20P	292	158	64	312	24	46	31.5	31	0.0449	9.0	7.5
		FL1L2DD12	Display box	—	250	188	195	1332	4	51.5	40	21.5	0.0443	7.0	5.3
	Classic Flashlights	FL1L2CB2R14P	Blister Pack	2 x R14P	240	131	50	170	24	47	26	20	0.0244	4.1	5.0
	Classic Flashlights	FL1L2AAB2R6P	Blister Pack	2 x R6P	211	99	38	84	60	40	30	23	0.0276	6.0	5.3
		FL1L2AAD24	Display box	—	230	154	150	1116	8	48	33	32.5	0.0515	10.5	8.9

Super Bright LED



Super Bright

- Rubberized durable case
- Long Continuous Lighting up to 14hrs*
- Super Bright in-build LED

Best for:
Traveling, hiking, camping, fishing and athletics

Model#	Specifications						
	LEDs	LED Type	Luminous Flux	Battery Mode	Body Material	Available Colors	Water Resistant (Y/N)
SL3013	1	white color LED	5lm	3 x LR44	Plastic	<div style="display: flex; flex-direction: column; gap: 5px;"> <div> Yellow</div> <div> Red</div> <div> Green</div> <div> Blue</div> </div>	N

SL3013



LED

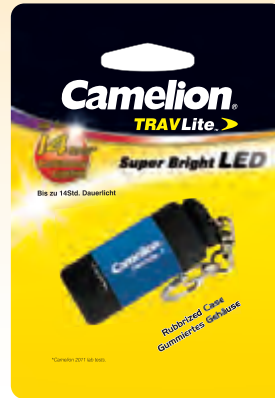
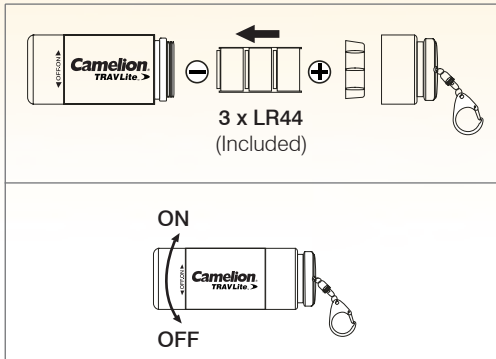

SL3013-3LR44BP



SL3013-3LR44-PB36



Packaging Details

Item#	Packaging Type	Included Batteries	Blister/Box Details					Outer Carton Details					
			Dimensions (mm)			Net Weight (g)	Packs/ Carton	Dimensions (cm)			Volume (M ³)	Gross Weight (Kg)	Net Weight (kg)
			L Length	W Width	D Depth			L Length	W Width	H Height			
SL3013-3LR44BP	Blister Pack	3xLR44	167	155	103	26	192	32.5	31.5	45.5	0.0466	7.7	5.0
SL3013-3LR44-PB36	Display Box	3xLR44	395	165	225	850	12	41.5	24.5	34.5	0.0347	11.0	10.2

Penlight Flashlights

An Elegant Gift and a Handy Tool



- Powerful Spot Beam
- Durable Aircraft Aluminum
- Strong Pocket Clip
- Push Button Switch



Best for:

- Useful tool for doctors
- Elegant, fashionable gift
- Great for hard to reach recesses and gaps



			Specifications					
Product Picture	Name	Model #	Type of Bulb	Voltage/Ampere	Battery Mode	Body Material	Available Colors	Water Resistant
	Penlight Flashlight	DL2AAAS	Vakuum	2.2V/250mA	2AAA	Aircraft aluminum	<input type="checkbox"/> Silver	<input checked="" type="checkbox"/>

			Packaging Details												
Pack. Picture	Name	Item#	Packaging Type	Included Batteries	Blister/Box Details				Outer Carton Details						
					Dimensions (mm)			Net Weight (g)	Packs/ Carton	Dimensions (cm)			Volume (M ³)	Gross Weight (Kg)	Net Weight (kg)
					L Length	W Width	D Depth			L Length	W Width	D Depth			
	Penlight Flashlight	DL2AAAS	Blister Pack	2 x R03P	200	155	115	56	100	48.5	39.0	25.0	0.0479	5.6	7.0

Flashlights Replacement Bulbs

LED

Replace Krypton and LED Bulbs Energy Saving

Lifetime Up to 10,000 Hours

3V 4.5V 6V

2x Batteries 3x Batteries 4x Batteries



3V

4.5V

6V

Specifications

Model No.	Lamp Type	Voltage (V)	Current (mA)	Power (W)	Luminous Flux (lm)	Color Temperature (K)	Base Type	Average Life (hrs)	Battery Type
BL304 WN	LED Flashlight Bulb	3.0	130	0.4	30	6000-8000 (Cool White)	P 13.5S	10,000	2x(AA/AAA/D/C)
BL406 WN	LED Flashlight Bulb	4.5	130	0.6	38	6000-8000 (Cool White)	P 13.5S	10,000	3x(AA/AAA/D/C) 3LR12,3R12
BL608 WN	LED Flashlight Bulb	6.0	130	0.8	42	6000-8000 (Cool White)	P 13.5S	10,000	4x(AA/AAA/D/C), 4R25

Packaging Details

Pack. Picture	Name	Item #	Packaging Type	Blister/Box Details			Net Weight (g)	Packs/ Carton	Outer Carton Details			Volume (M ³)	Gross Weight (Kg)	Net Weight (kg)
				Dimensions (mm)					Dimensions (cm)					
				L Length	W Width	D Depth			L Length	W Width	D Depth			
	LED Replacement Bulbs	BL304WN-BP1	Blister Pack	92	55	14	6	480	30.5	30	24.8	0.0227	4.4	2.4
		BL406WN-BP1		92	55	14	6	480	30.5	30	24.8	0.0227	4.4	2.4
		BL608WN-BP1		92	55	14	6	480	30.5	30	24.8	0.0227	4.4	2.4

CT-Series LED Flashlights







High grade aluminium flashlight with maximum illumination

- High Performance Chip Module SMD Technology
- Unbreakable Anodized Aluminium Alloy
- Ultra-High Luminosity

Best for:

- Security, police, military, emergency response
- Ideal for work, outdoor and general purpose activities

Product Picture	Name	Model #	Specifications						
			LEDs	LED Type	Lumens	Battery Mode	Body Material	Available Colors	Water Resistant
	3 Watt Flashlight with S.O.S. Function	CT4002	1	High-power-chip SMD Technology	120lm	3 x AAA	Aluminium	Black	✗
	9 LED Flashlight	CT4004	9	LED Technology	120lm	3 x AAA	Aluminium	Black Silver	✗
	30 LED Flashlight	CT4005	30	LED Technology	120lm	2 x D	Aluminium	Black	✗
	3 Watt Flashlight	CT4010	1	High-power-chip SMD Technology	130lm	3 x AAA	Aluminium	Silver	✗

CT4002



3 Watt LED



CT4004



9 LED



CT4005



30 LED



CT4010



3 Watt LED



Packaging Details

Pack. Picture	Name	Item#	Packaging Type	Included Batteries	Blister/Box Details			Net Weight (g)	Packs/ Carton	Outer Carton Details					
					Dimensions (mm)					Dimensions (cm)			Volume (M ³)	Gross Weight (Kg)	Net Weight (kg)
					L Length	W Width	D Depth			L Length	W Width	D Depth			
	3 Watt Flashlight with S.O.S. Function	CT4002	Double blister	3 x LR03	244	123	40	191.6	120	51	38	56	0.1085	20	19
	9 LED Flashlight	CT4004	Double blister	3 x R03P	244	123	40	149.9	120	51	38	56	0.1085	20	19
	30 LED Flashlight	CT4005	Double blister	—	345	180	60	397.3	40	74	45	30.5	0.1016	17	16
	3 Watt Flashlight	CT4010	Double blister	3 x LR03	242	121	35	153.8	120	51	38	56	0.1085	20	19

CT-Series LED Flashlights

Best Lighting for Outdoors



LED Lantern

Key Features	Solar Lantern	1 Watt Table Lantern
Lighting Mode	100 % / 50 %	100 % / 50 % /Flashing
Long Life Use	3 h	17 h
Key Applications	Outdoors, Camping, Travel	

- **Effective Lighting**
- **LED Technology provides outstanding Illumination and high efficiency**
- **Handy Easy grip, adjustable handle with hook**
- **Rubber booted push switch**

3 Watt Headlight

- **High Performance Chip Module SMD Technology**
- **Low Power Consumption**
- **Ultra-High Luminosity**
- **3 different LED mode**

Best for:

Camping, Outdoors, Caving

Product Picture	Name	Model #	Specifications						
			LEDs	LED Type	Lumens	Battery Mode	Body Material	Available Colors	Water Resistant
	36 LED Solar Lantern	Solar Lantern	36	LED Technology	up to 100lm	4 x D / inbuild rechargeable battery	Rubberized Aluminium	■ Black	✗
	1 Watt LED Table Lantern	CT4008	1	High-power-chip SMD Technology	70lm	4 x AA	Rubberized Aluminium	■ Black	✗
	3 Watt LED Headlight	CT4007	1	High-power-chip SMD Technology	130lm	3 x AAA	Plastic	■ Black	✗

Solar Lantern

36 LED

CE



Solar Lantern



4 260030 255474

CT4008

1 Watt Table Lantern

CE



CT4008



4 260030 255771

CT4007

3 Watt Headlight

CE





CT4007



4 260030 255764

Packaging Details

Pack. Picture	Name	Item#	Packaging Type	Included Batteries	Blister/Box Details			Outer Carton Details							
					Dimensions (mm)			Packs/ Carton	Dimensions (cm)			Volume (M ³)	Gross Weight (Kg)	Net Weight (kg)	
					L Length	W Width	D Depth		L Length	W Width	D Depth				
	36 LED Solar Lantern	Solar Lantern	Hardbox	—	265	140	140	681.7	24	57.5	43.5	37.5	0.0938	23	20
	1 Watt LED Table Lantern	CT4008	Double blister	—	242	123	50	164.7	100	57	54.5	36	0.1119	21.5	18.5
	3 Watt LED Headlight	CT4007	Double blister	3 x LR03	245	125	100	150.5	100	52	38	58.5	0.1156	15.5	13.5

Work Light + Multi Light 2 in 1

Ideal Lighting for Workplace



Work Light + Multi Light 2 in 1

- Outstanding illumination provided by 3W COB LED
- Strong magnet button and 360 degrees swivel hook
- Durable rubberized ABS casing for better comfort

Best for:

Professionals, home and office use.

Model#	LED Type	Luminous Flux	Battery Mode	Body Material	Available Colors	Water Resistant (Y/N)
SL5240N	3W COB LED	220lm	3 x AA	Plastic	 Black+Orange	N
SL7280N	3W COB LED	200lm	3 x AAA	Plastic	 Black+Orange	N

Work Light



SL5240N
3W COB LED



Multi Light 2 in 1



SL7280N
3W COB LED



Item#	Packaging Type	Included Batteries	Packaging Details										
			Blister/Box Details				Outer Carton Details						
			Dimensions (mm)			Net Weight (g)	Packs/ Carton	Dimensions (cm)			Volume (M ³)	Gross Weight (Kg)	Net Weight (kg)
L Length	W Width	D Depth	L Length	W Width	H Height								
SL5240N-3R6PD12	Display Box	3xR6P	202	227	210	1750	4	49	24	46	0.0541	9.0	7.0
SL7280N-3R03PD12	Display Box	3xR03P	143	232	108	1250	8	62.5	34	22.5	0.0479	11.5	10.5

Ideal Lighting for Workplace

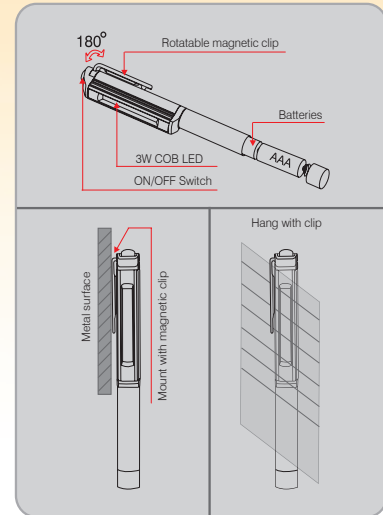

LED Inspection Light

- Powerful 3W COB lighting
- Durable CNC-machined aluminum alloy body
- Rotatable magnetic clip
- None replace needed LED of up to 50,000 hours lifespan



T11-3R03PD12



Specifications

Model#	LEDs	LED Type	Luminous Flux	Battery Mode	Body Material	Available Colors	Water Resistant (Y/N)
T11	1	3W COB LED	200lm	3 x AAA	Plastic	<div style="display: flex; gap: 5px;"> <div style="width: 10px; height: 10px; background-color: blue; border: 1px solid black;"></div> Blue <div style="width: 10px; height: 10px; background-color: red; border: 1px solid black;"></div> Red <div style="width: 10px; height: 10px; background-color: silver; border: 1px solid black;"></div> Silver </div>	N

Packaging Details

Item#	Packaging Type	Included Batteries	Blister/Box Details					Outer Carton Details						
			Dimensions (mm)			Net Weight (g)	Packs/ Carton	Dimensions (cm)			Volume (M ³)	Gross Weight (Kg)	Net Weight (kg)	
			L Length	W Width	D Depth			L Length	W Width	H Height				
T11-3R03PD12	Display Box	3x R03P	202	125	40	94	48	58	36.5	22.5	0.0477	5.5	4.5	

Domestic Lighting

Ideal Lighting for Household

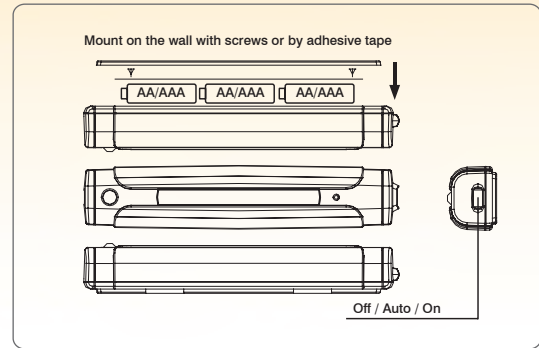
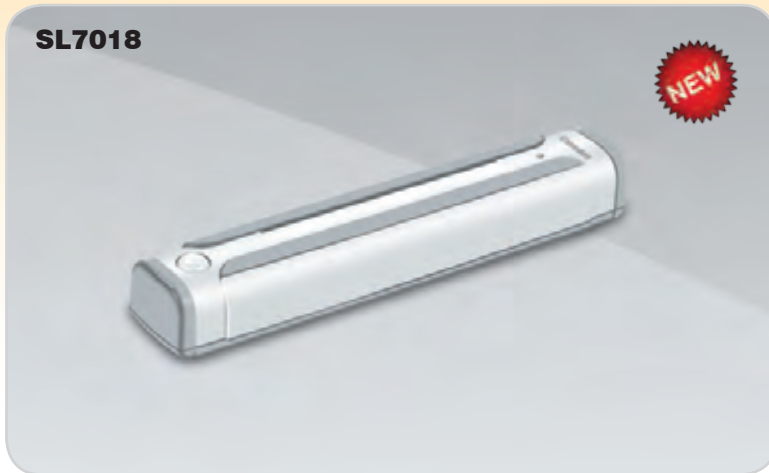

Sensor Light

- Wide Sensory Angles
- Long sensory distance
- Choice of installation by adhesive tape or screws
- Detachable body from the mounted base

Best for:

Bedrooms, hallways, Staircase, washroom, closets and drawers

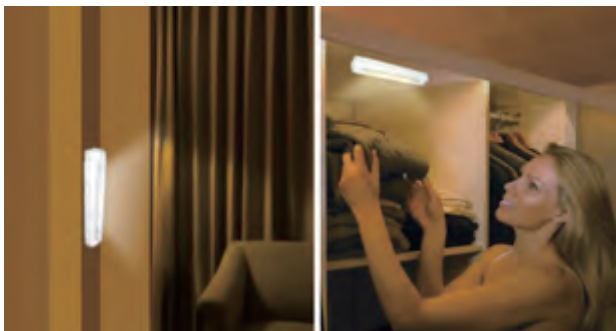

Specifications

Model#	Bulb Type	Luminous Flux	Battery Mode	Body Material	Available Colors	Water Resistant (Y/N)
SL7018	Super Bright LED	15lm	3 x AA	Plastic	<input type="checkbox"/> White	N

Packaging Details

Item#	Packaging Type	Included Batteries	Blister/Box Details				Outer Carton Details						
			Dimensions (mm)			Net Weight (g)	Packs/ Carton	Dimensions (cm)			Volume (M ³)	Gross Weight (Kg)	Net Weight (kg)
			L Length	W Width	D Depth			L Length	W Width	H Height			
SL7018-3R6TB	Blister Pack	3 x R6P	190	110	48	139	48	52.5	44.5	21.5	0.0502	7.9	6.7

Promotional Accessories



Sales Promotional Material

Maximum Impact, Minimum Space, Optimal Sales

When you want your Camelion products to have maximum impact you need optimal POP promotional material.

For the latest sales accessories and premiums please contact us at info@camelion.com

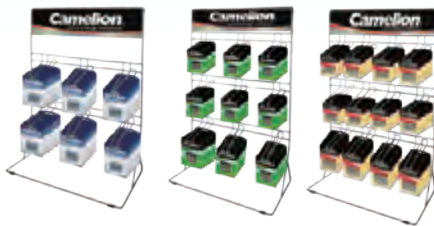

WCD-02

WCD-03

WCD-05

Metal Counter Display

- WCD-02: 33 x 43 x 22cm (6 hooks)
- WCD-03: 33 x 58 x 22cm (9 hooks)
- WCD-05: 44 x 66 x 20cm (12 hook)
- Sturdy steel construction for long use
- Easy to see, easy to reach
- Light weight for easy portability
- Available in Metal Black



WCD-06

Metal Counter Display

- 10 Racks 20 hooks L = 12,5cm
- Simple and lightweight design
- Dimensions: W x H x D: 30x158x35cm

Qty for Each Hook:

- AAA Size: 10packs
- AA Size: 7packs
- 9V Size: 6packs
- C Size: 5packs
- D Size: 4packs



Metal Counter Display

MFD-02

- Use metal racks to expand each peg
- Professional slim and elegant design
- Rugged steel construction for long life
- Easy assembly by interlocking joints, no screws or hammers (Instructions included)
- W x H x D: 46 x 70 x 26cm



Metal Floor Display

MFD-03

- Up to 300-400 peg holes (ideally holds 20-30 large / medium size packages)
- Use metal racks to expand each peg
- Professional slim and elegant design
- Rugged steel construction for long life
- Easy assembly by interlocking joints, no screws or hammers (Instructions included)
- W x H x D: 80x180x61cm



Metal Floor Display

MFD-06

Rugged steel construction for long life

With this display you present your Camelion products appealing and clear. The lightly curved floor display focusses attention directly to the product assortment, and moreover emphasizes the Camelion brand - a major boost for a positive purchase decision.

B x H x T: 107 x 177 x 33cm

Display Box

DR-16



DR16 Promotion Display "4+4"

- Plus Alkaline floor display for value pack "4+4" (AA I AAA)
- Hight (total) 1,17m + palett
- Width 0,55m
- Depth 0,38m
- Material Cardboard
- Surface shiny
- 9x grids = 9 storage compartments
- 72 x LR6 „4+4“ (6 storage compartments)
12 blister per storage compartments
- 48 x LR03 „4+4“ (3 storage compartments)
120 blister total



Plus Alkaline LR6 BP8 „4+4“
Art. Nr. 110 44806
EAN 4260216451096
carton 72 / innerbox 12



Plus Alkaline LR03 BP8 „4+4“
Art. Nr. 110 44803
EAN 4260216451102
carton 72 / innerbox 12



DR16 Promotion Display "8+4 free"

- Plus Alkaline floor display for promotion blister "8+4 free" (AA I AAA)
- Hight (total) 1,17m + palett
- Width 0,55m
- Depth 0,38m
- Material Cardboard
- Surface shiny
- 12x grids = 12 storage compartments
- 48x LR6 „8+4 free“ (8 storage compartments)
6 blister per storage compartment
- 36 x LR03 „8+4 free“ (4 storage compartments)
84 blister total



Plus Alkaline LR6 BP8+4
Art. Nr. 110 84006
EAN 4260216453915
carton 48 / innerbox 6



Plus Alkaline LR03 BP8+4
Art. Nr. 110 84003
EAN 4260216453922
carton 72 / innerbox 6



DR16 Promotion Display "24"

- Plus Alkaline floor display for plastic box "24" (AA I AAA)
- Hight (total) 1,17m + palett
- Width 0,55m
- Depth 0,38m
- Material Cardboard
- Surface shiny
- 32x grids = 32 storage compartments
- 60 x LR6 „24“ (20 storage compartments)
3 boxes per storage compartment
- 48 x LR03 „24“ (12 storage compartments)
4 boxes per storage compartment
- 108 boxes total



Plus Alkaline LR6 PB24
Art. Nr. 111 02406
EAN 4260033150455
carton 30 / innerbox 6



Plus Alkaline LR03 PB24
Art. Nr. 111 02403
EAN 4260033150462
carton 30 / innerbox 6



Aisle Display Box

DR-05

The new display rack is designed to make items easier to reach and retrieve. You can order different kinds of batteries according to your sales. It is easy for transportation and set up in the store and supermarket. It also uses some new branding elements like Mr Camelion.

- Use of informative images
- Clear Branding
- Light, durable materials
- Easy to place and retrieve items
- Clear Messages
- W x H x D: 36,5x137x44cm



Desktop Acrylic Display Stand

ADS-01

- Compact Size suitable on the shelf or near the cashier
- 15 Flexible hooks for different series of products (hook: L=5cm)
- Dimensions (W x H x D): 345x 480x135mm(*8 Depth) 75°
- Elegant design : Economical and versatile
- Durable and light : Made by acrylic material

Six Options:





DR-11

DR-12

Battery Aisle Display Box

- Battery shaped floorstand trigger and strengthen brand recognition
- Brand space maximized through strong printed graphics
- Strong structural integrity for easy moving
- Ideal for most retail markets placement
 - DR11: W x H x D: 60 x 158 x 31 cm
 - DR12: W x H x D: 42 x 70.5 x 21 cm



SPK-01

SPK-02

The AlwaysReady and Digi Alkaline Speaker

The AlwaysReady and Digi Alkaline Speaker deliver impressive volume and clarity, it is small enough to fit in your pocket and uses a standard headphone jack to connect to your music device, ideally effortless amplify your favorite tunes via any iPhone, iPod, MP3/4 player, Smartphone, or laptop.



Caps

C-01

Comfortable golf caps with all-size fits design, in trendy corporate colors.



Wristband

WB-01



Non Woven Fiber

HB-03



Non Woven Bag

HB-04

- Material: fiber
- W x H x D: 38x34x10cm



Plastic

HB-05

- W x H x D: 30x38x6cm



Promotional Tote Bag

HB-06

- Material: fiber
- W x H x D: 38x34x12cm



Balloon Pop Up

AIRB-01



Promotion Bag

(Transparent)

PTB-01

- W x H : 13x20cm



Ball Pen

PAN-03B

PAN-03R



Gel Pen with Rubber Coated

PAN-02



Memo Post It

• W x H: 41.5 x 58 cm

PB-03

PB-04



AlwaysReady Poster

POSTER-AR

• W x H: 41.5x58cm



Notebook

PM-07G

- Spiral bound
- Durable plastic front and back
- Includes 6 Page color product brochure
- W x H: 17x19cm



AlwaysReady Leaflet

LFLT-AR

- LEFLT-AlwaysReady
- W x H: 14x21cm



Posters

Our sales literature and marketing materials are created to bring out the benefits of Camelion products.

- Professionally produced and designed
- Simple and powerful messages
- Useful information
- Designed with the end-user in mind
- W x H: 39x57cm



Supermarket Banner

Model: SMB-LI/SMB-DA/SMB-PA/SMB-AR/SMB-NH

- This banner is suitable for Supermarkets, retail stores, malls, etc. It is excellent advertisement for Camelion Brand.
- W x H: 45 x 60 cm



Floor Sticker

Model: FG-LI/FG-DA/FG-PA/FG-AR/FG-NH

- The floor sticker is abrasion resistance and durable. Can be used in the lobby, supermarket's aisles, shopping malls, or any public place.
- W x H: 150 x 110 cm, 110 x 80 cm, 80 x 60 cm



X BannerStand

Available :
Charger and Battery banners
• W x H: 80 x 180 cm



Step Stickers

- This announcement can be used in the steps of supermarkets, shopping malls and many other places.
- W x H: 200 x 16 cm

Let Us Offer You More Energy Solutions Today

Camelion has provided consumer friendly solutions for customers worldwide for over 20 years. Our customers have been consistently satisfied with our quality, prices and attention to detail. We offer a broad range of energy solutions. Try us out today.

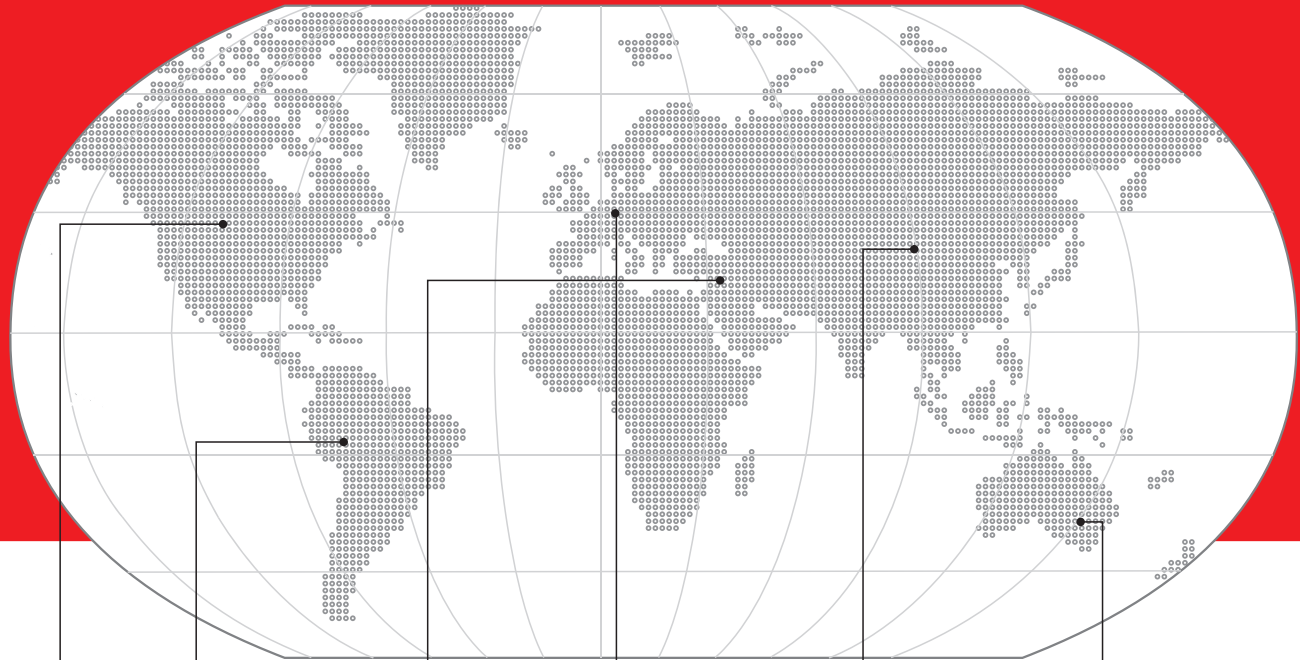

North America
• Canada
• U. S. A

- Caribbean/
Latin America**
- Argentina
 - Brazil
 - Bolivia
 - Chile
 - Colombia
 - Costa Rica
 - Cuba
 - Dominica
 - Ecuador
 - EL Salvador
 - Guatemala
 - Haiti
 - Mexico
 - Nicaragua
 - Panama
 - Paraguay
 - Peru
 - Puerto Rico
 - Trinidad and Tobago
 - Uruguay
 - Venezuela

- Middle East
/Africa**
- Algeria
 - Benin
 - Egypt
 - Iran
 - Israel
 - Kuwait
 - Lebanon
 - Sierra Leone
 - Saudi Arabia
 - Syria
 - S. Africa
 - Tunisia
 - U.A.E.
 - Uganda

- Europe**
- Austria
 - Albania
 - Andorra
 - Belarus
 - Belgium
 - Bosnia
 - Bulgaria
 - Czech Republic
 - Croatia
 - Cyprus
 - Denmark
 - Estonia
 - Finland
 - France
 - Germany
 - Georgia
 - Greece
 - Hungary
 - Iceland
 - Ireland
 - Italy
 - Latvia
 - Lithuania
 - Luxembourg
 - Macedonia
 - Malta
 - Netherland
 - Norway
 - Portugal
 - Poland
 - Romania
 - Russia
 - Serbia
 - Slovakia
 - Slovenia
 - Spain
 - Sweden
 - Switzerland
 - Turkey
 - United Kingdom
 - Ukraine

- Asia**
- Afghanistan
 - Armenia
 - Azerbaijan
 - Bangladesh
 - Cambodia
 - China
 - Hong Kong
 - Indonesia
 - India
 - Iraq
 - Japan
 - Jordan
 - Korea
 - Kazakhstan
 - Lao
 - Malaysia
 - Pakistan
 - Philippines
 - Sri Lanka
 - Taiwan
 - Thailand
 - Turkmenistan
 - Vietnam
 - Yemen

- Oceania**
- Australia
 - Fiji
 - New Zealand

EUROPE HEAD OFFICE / WAREHOUSE

Camelion Batterien GmbH.
Bergiusstr. 53-59.D - 12057 Berlin,
Germany

For more information visit www.camelion.com

Copyright ©2017 Batterien GmbH, All rights reserved.