

Product Catalogue 2018 | 2019



Camelion®
...for more energy

BATTERY • RECHARGEABLE • CHARGER • POWERBANK • FLASHLIGHT

www.camelion.com



BATTERY • RECHARGEABLE • CHARGER • POWERBANK • FLASHLIGHT

CONTENT

Primary Batteries

Lithium	6
9V Lithium	6
Digi Alkaline	7
Plus Alkaline	8
Super Heavy Duty (Blue)	14
Super Heavy Duty (Green)	15
Photo Lithium	18

Electronic Button Cells

Electronics Lithium	19
Electronics Alkaline	20
Remote Control Batteries	21
Electronics Silver Oxide	22
Zinc Air	22
Battery Accessoires	23
Battery Selection Chart	24

Rechargeable Batteries

AlwaysReady	26
Ni-MH	28
Lithium-ion Rechargeable Batteries	31

Battery Chargers

Ultra Fast Chargers

BC-0907	33
---------	----

Super Fast Chargers

BC-0905A	34
BC-1010B	35

Fast Chargers

BC-1002A	36
BC-1012	37

Overnight Chargers

BC-1001A	38
BC-0904S	39
BC-0901	40

Universal Chargers

CM9398GS	41
CM3298	42
CM9388	43
LBC-312	44
LBC-313-1	45

Lithium-ion Charger

LBC-305	46
CM500	47

Battery Charging Table

48

Power Supplies

Power Banks

PS675, PS679 **51**

USB Power Adapters

AD568, AD569 **52**

USB Car Chargers

DD801, DD802 **53**

DD823 **54**

3in1 USB Charging Kit

AD568+DD811+CDC015 **54**

Device Chart **55**

Battery Powered Flashlights

SuperBright™ Flashlights

Multi-head LED Classic
FL6L2D **57**

Classic Flashlight
FL1L2D, FL1L2C, FL1L2AA **58**

Multi-head LED Search Lamp
FL-16LED, FL-9LED **60**

LED Search Lamp
CM25L **60**

Super Bright LED
SL3013 **62**

TRAVLite™ Flashlights

LED Pocket Flashlight
HP7011 **64**

LED Rubber Flashlight
PT1L2D, PT1L2AA **64**

Professional Products

Penlight
DL2AAAS **66**

Inspection Light
T11 **67**

CT-Series LED Flashlights

High grade aluminium flashlight with maximum illumination
CT4004, CT4005, CT4010 **68**

LED Lantern
Solar Lantern, CT4008 **70**

3 Watt Headlight
CT4007 **70**

Work Lights

SL5240N **72**

Multi Light 2 in 1
SL7280N **72**

3W COB LED
S31 **74**

2-IN-1 Spotlight
S32 **75**

Professional Work Light
S20, S21, S22 **76**

Domestic Lighting

Sensor Light
SL7018 **78**

Flashlight Replacement Bulbs

LED bulbs **79**

Promotional

80

Primary Batteries

Lithium P⁷ Batteries



Camelion Lithium P7™ batteries offer a unique combination of lightness and high energy density. As Camelion's most powerful primary battery, the P7 batteries, offer unbeatable performance for your high drain devices such as digital cameras, music players and games. It can be stored up to 10 years.

EMPORIO URTEIL	
Camelion Lithium AA	
GUT	81,7 %
22 AA-Batterien im Vergleichstest: Heft 11/2008	



FR6-BP2

1.5V AA



Packaging		
Blister	2 pcs/pack	Gross Weight: 9.3 kg
Inner Box	12 packs/box	Volume: 0.0251 cbm
Outer Carton	216 packs/carton	

Dimensions	
Blister (mm)	84(W) x 114(H) x 15(D)
Inner Box (mm)	131(L) x 98(W) x 86(H)
Outer Carton (cm)	41.5(L) x 27.5(W) x 22.0(H)



FR03-BP2

1.5V AAA



Packaging		
Blister	2 pcs/pack	Gross Weight: 8.0 kg
Inner Box	12 packs/box	Volume: 0.0237 cbm
Outer Carton	288 packs/carton	

Dimensions	
Blister (mm)	84(W) x 114(H) x 11(D)
Inner Box (mm)	119(L) x 75(W) x 86(H)
Outer Carton (cm)	32.5(L) x 26.0(W) x 28.0(H)

9V Lithium Battery

The new Lithium 9V Battery from Camelion is a high capacity battery designed to provide long lasting life and stable operating voltage.

- Up to 5x Longer Lasting*
- Low Self Discharge
- Anti leakage crimp design
- Temperature Range -20°C to +55°C
- Non-rechargeable
- 10 Year Shelf Life
- High And Stable Operating Voltage

*compare with alkaline batteries. Camelion 2010 Lab Tests.



ER9V-SP1

9V



Packaging		
Shrink	1 pcs/pack	Gross Weight: 14.5 kg
Inner Box	20 packs/box	Volume: 0.0083 cbm
Outer Carton	200 packs/carton	

Dimensions	
Shrink (mm)	25.5(W) x 48.5(H) x 17.5 (D)
Inner Box (mm)	145(L) x 74(W) x 54(H)
Outer Carton (cm)	39.0(L) x 17.5(W) x 13.5(H)



ER9V-BP1

9V



Packaging		
Blister	1 pcs/pack	Gross Weight: 8.3 kg
Inner Box	12 packs/box	Volume: 0.0246 cbm
Outer Carton	192 packs/carton	

Dimensions	
Blister (mm)	84(W) x 114(H) x 18(D)
Inner Box (mm)	123(L) x 117(W) x 86(H)
Outer Carton (cm)	36.2(L) x 26.3(W) x 25.8(H)

Digi Alkaline Batteries

Camelion Digi Alkaline batteries are the right solution for many electronic devices including digital cameras, music players, and boom boxes. Using a new technology they offer long lasting power for high drain devices.

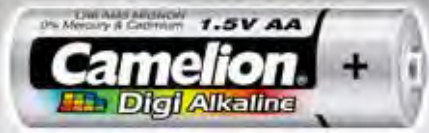

LR20-BP2DG

1.5V D



Packaging		Gross Weight:
Blister	2 pcs/pack	15.0 kg
Inner Box	6 packs/box	Volume:
Outer Carton	48 packs/carton	0.0157 cbm

Dimensions

Blister (mm)	84(W) x 114(H) x 34(D)
Inner Box (mm)	160(L) x 110(W) x 92(H)
Outer Carton (cm)	33.5(L) x 19.5(W) x 24.0(H)



LR14-BP2DG

1.5V C



Packaging		Gross Weight:
Blister	2 pcs/pack	14.3 kg
Inner Box	6 packs/box	Volume:
Outer Carton	96 packs/carton	0.0227 cbm

Dimensions

Blister (mm)	84(W) x 114(H) x 27(D)
Inner Box (mm)	140(L) x 90(W) x 92(H)
Outer Carton (cm)	37.5(L) x 29.5(W) x 20.5(H)



LR6-BP4DG

1.5V AA



Packaging		Gross Weight:
Blister	4 pcs/pack	15.4 kg
Inner Box	12 packs/box	Volume:
Outer Carton	144 packs/carton	0.0166 cbm

Dimensions

Blister (mm)	84(W) x 114(H) x 15(D)
Inner Box (mm)	131(L) x 98(W) x 86(H)
Outer Carton (cm)	27.5(L) x 28.0(W) x 21.5(H)



LR6-BP2DG

1.5V AA



Packaging		Gross Weight:
Blister	2 pcs/pack	12.6 kg
Inner Box	12 packs/box	Volume:
Outer Carton	216 packs/carton	0.0251 cbm

Dimensions

Blister (mm)	84(W) x 114(H) x 15(D)
Inner Box (mm)	131(L) x 98(W) x 86(H)
Outer Carton (cm)	41.5(L) x 27.5(W) x 22.0(H)



LR03-BP4DG

1.5V AAA



Packaging		Gross Weight:
Blister	4 pcs/pack	15.9 kg
Inner Box	12 packs/box	Volume:
Outer Carton	288 packs/carton	0.0237 cbm

Dimensions

Blister (mm)	84(W) x 114(H) x 11(D)
Inner Box (mm)	119(L) x 75(W) x 86(H)
Outer Carton (cm)	32.5(L) x 26.0(W) x 28.0(H)



LR03-BP2DG

1.5V AAA



Packaging		Gross Weight:
Blister	2 pcs/pack	9.1 kg
Inner Box	12 packs/box	Volume:
Outer Carton	288 packs/carton	0.0237 cbm

Dimensions

Blister (mm)	84(W) x 114(H) x 11(D)
Inner Box (mm)	119(L) x 75(W) x 86(H)
Outer Carton (cm)	32.5(L) x 26.0(W) x 28.0(H)



6LR61-BP1DG

9V



Packaging		Gross Weight:
Blister	1 pcs/pack	11.2 kg
Inner Box	12 packs/box	Volume:
Outer Carton	192 packs/carton	0.0246 cbm

Dimensions

Blister (mm)	84(W) x 114(H) x 18(D)
Inner Box (mm)	123(L) x 117(W) x 86(H)
Outer Carton (cm)	36.2(L) x 26.3(W) x 25.8(H)

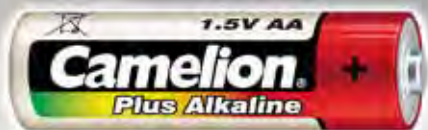

Plus Alkaline Batteries

Camelion Plus Alkaline batteries offer reliable power for high drain devices. They deliver stable and long lasting current couple to a long shelf life to support high drain devices such as CD players, toys, PDAs, and electronic games.



LR20-BP2 

1.5V D 4 260033 150004

Packaging		Gross Weight:
Blister	2 pcs/pack	15.0 kg
Inner Box	6 packs/box	Volume:
Outer Carton	48 packs/carton	0.0157 cbm

Dimensions

Blister (mm)	84(W) x 114(H) x 34(D)
Inner Box (mm)	160(L) x 110(W) x 92(H)
Outer Carton (cm)	33.5(L) x 19.5(W) x 24.0(H)



LR14-BP2 

1.5V C 4 260033 150011

Packaging		Gross Weight:
Blister	2 pcs/pack	15.6 kg
Inner Box	6 packs/box	Volume:
Outer Carton	96 packs/carton	0.0227 cbm

Dimensions

Blister (mm)	84(W) x 114(H) x 27(D)
Inner Box (mm)	140(L) x 90(W) x 92(H)
Outer Carton (cm)	37.5(L) x 29.5(W) x 20.5(H)



LR6-BP4 

1.5V AA 4 260033 150028

Packaging		Gross Weight:
Blister	4 pcs/pack	15.5 kg
Inner Box	12 packs/box	Volume:
Outer Carton	144 packs/carton	0.0166 cbm

Dimensions

Blister (mm)	84(W) x 114(H) x 15(D)
Inner Box (mm)	131(L) x 98(W) x 86(H)
Outer Carton (cm)	27.5(L) x 28.0(W) x 21.5(H)



LR6-BP2 

1.5V AA 4 260033 150035

Packaging		Gross Weight:
Blister	2 pcs/pack	12.6 kg
Inner Box	12 packs/box	Volume:
Outer Carton	216 packs/carton	0.0251 cbm

Dimensions

Blister (mm)	84(W) x 114(H) x 15(D)
Inner Box (mm)	131(L) x 98(W) x 86(H)
Outer Carton (cm)	41.5(L) x 27.5(W) x 22.0(H)



4 + 4LR6 

1.5V AA 4 260216 451096

Packaging		Gross Weight:
Blister	8 pcs/pack	15.5 kg
Inner Box	12 packs/box	Volume:
Outer Carton	72 packs/carton	0.0199 cbm

Dimensions

Blister (mm)	168(W) x 114(H) x 15(D)
Inner Box (mm)	175(L) x 140(W) x 10.8(H)
Outer Carton (cm)	43.5(L) x 19.0(W) x 24.0(H)



LR6-HP12 

1.5V AA 4 260033 150424

Packaging		Gross Weight:
Blister	12 pcs/pack	14.1 kg
Outer Carton	48 packs/carton	Volume:
		0.0098 cbm

Dimensions

Blister (mm)	170(W) x 99(H) x 15(D)
Outer Carton (cm)	35.5(L) x 22.0(W) x 12.5(H)



LR6-BP10 

1.5V AA 4 260033 150097

Packaging		Gross Weight:
Blister	10 pcs/pack	18.8 kg
Inner Box	12 packs/box	Volume:
Outer Carton	72 packs/carton	0.0239 cbm

Dimensions

Blister (mm)	84(W) x 190(H) x 15(D)
Inner Box (mm)	315(L) x 104(W) x 90(H)
Outer Carton (cm)	33.0(L) x 31.5(W) x 23.0(H)



LR03-BP2 

1.5V AAA 4 260033 150059

Packaging		Gross Weight:
Blister	2 pcs/pack	9.1 kg
Inner Box	12 packs/box	Volume:
Outer Carton	288 packs/carton	0.0237 cbm

Dimensions

Blister (mm)	84(W) x 114(H) x 11(D)
Inner Box (mm)	119(L) x 75(W) x 86(H)
Outer Carton (cm)	32.5(L) x 26.0(W) x 28.0(H)



LR03-BP4
1.5V AAA
 4 260033 150042

Packaging		
Blister	4 pcs/pack	Gross Weight: 8.3 kg
Inner Box	12 packs/box	Volume: 0.0120 cbm
Outer Carton	144 packs/carton	

Dimensions

Blister (mm)	84(W) x 114(H) x 11(D)
Inner Box (mm)	119(L) x 75(W) x 86(H)
Outer Carton (cm)	27.5(L) x 25.5(W) x 17.0(H)



4+4LR03
1.5V AAA
 4 260216 451102

Packaging		
Blister	8 pcs/pack	Gross Weight: 8.9 kg
Inner Box	12 packs/box	Volume: 0.0150 cbm
Outer Carton	72 packs/carton	

Dimensions

Blister (mm)	168(W) x 114(H) x 11(D)
Inner Box (mm)	175(L) x 130(W) x 85(H)
Outer Carton (cm)	41.5(L) x 19.0(W) x 19.0(H)



LR03-BP10
1.5V AAA
 4 260033 150103

Packaging		
Blister	10 pcs/pack	Gross Weight: 9.4 kg
Inner Box	12 packs/box	Volume: 0.0152 cbm
Outer Carton	72 packs/carton	

Dimensions

Blister (mm)	84(W) x 165(H) x 11(D)
Inner Box (mm)	243(L) x 85(W) x 90(H)
Outer Carton (cm)	30.0(L) x 26.0(W) x 19.5(H)



6LR61-BP1
9V
 4 260033 150066

Packaging		
Blister	1 pcs/pack	Gross Weight: 11.2 kg
Inner Box	12 packs/box	Volume: 0.0246 cbm
Outer Carton	192 packs/carton	

Dimensions

Blister (mm)	84(W) x 114(H) x 18(D)
Inner Box (mm)	123(L) x 117(W) x 86(H)
Outer Carton (cm)	36.2(L) x 26.3(W) x 25.8(H)



LR1-BP2
1.5V N
 4 260033 150080

Packaging		
Blister	2 pcs/pack	Gross Weight: 6.3 kg
Inner Box	6 packs/box	Volume: 0.0181 cbm
Outer Carton	192 packs/carton	

Dimensions

Blister (mm)	84(W) x 114(H) x 12(D)
Inner Box (mm)	116(L) x 45(W) x 86(H)
Outer Carton (cm)	36.2(L) x 25.0(W) x 20.0(H)



LR1-BP5
1.5V N
 4 260216 455780

Packaging		
Blister	5 pcs/pack	Gross Weight: 10.8 kg
Inner Box	12 packs/box	Volume: 0.0150 cbm
Outer Carton	192 packs/carton	

Dimensions

Blister (mm)	50(W) x 160(H) x (D)
Inner Box (mm)	170(L) x 78(W) x 52(H)
Outer Carton (cm)	33.5(L) x 19.0(W) x 23.5(H)



LR61-BP2
1.5V AAAA
 4 260033 150295

Packaging		
Blister	2 pcs/pack	Gross Weight: 6.2 kg
Inner Box	12 packs/box	Volume: 0.0251 cbm
Outer Carton	288 packs/carton	

Dimensions

Blister (mm)	84(W) x 114(H) x 11(D)
Inner Box (mm)	128(L) x 75(W) x 86(H)
Outer Carton (cm)	32.5(L) x 27.6(W) x 28.0(H)



3LR12-BP1
4.5V
 4 260033 150073

Packaging		
Blister	1 pcs/pack	Gross Weight: 16.9 kg
Inner Box	6 packs/box	Volume: 0.0295 cbm
Outer Carton	144 packs/carton	

Dimensions

Blister (mm)	84(W) x 114(H) x 23(D)
Inner Box (mm)	160(L) x 75(W) x 86(H)
Outer Carton (cm)	36.0(L) x 33.5(W) x 24.5(H)



LR6 bulk
1.5V AA

Packaging		
Inner Box	60 pcs/box	Gross Weight: 17.8 kg
Outer Carton	720 pcs/carton	Volume: 0.0096 cbm

Dimensions

Single (mm)	14(W) x 50(H) x 14(D)
Inner Box (mm)	174(L) x 72(W) x 50(H)
Outer Carton (cm)	23.5(L) x 21.5(W) x 19.0(H)



LR03 bulk
1.5V AAA

Packaging		
Inner Box	60 pcs/box	Gross Weight: 14.7 kg
Outer Carton	1200 pcs/carton	Volume: 0.0084 cbm

Dimensions

Single (mm)	10(W) x 44.5(H) x 10(D)
Inner Box (mm)	83(L) x 52(W) x 45(H)
Outer Carton (cm)	29.0(L) x 19.0(W) x 15.0(H)



LR6-SP40HFB

1.5V AA



Packaging
Shrink 40 pcs/pack
Outer Carton 12 packs/carton
Gross Weight: 11.7 kg
Volume: 0.0075 cbm

Dimensions
Shrink (mm) 145(L) x 60(W) x 50(H)
Outer Carton (cm) 30.5(L) x 17.5(W) x 14.0(H)



LR03-SP40HFB

1.5V AAA



Packaging
Shrink 40 pcs/pack
Outer Carton 16 packs/carton
Gross Weight: 10.8 kg
Volume: 0.0051 cbm

Dimensions
Shrink (mm) 106(L) x 44(W) x 46(H)
Outer Carton (cm) 23.0(L) x 20.0(W) x 11.0(H)



LR6-SP2

1.5V AA



Packaging
Shrink 2 pcs/pack
Inner Box 20 packs/box
Outer Carton 360 packs/carton
Gross Weight: 17.9 kg
Volume: 0.0100 cbm

Dimensions
Shrink (mm) 28(W) x 50(H) x 14(D)
Inner Box (mm) 113(L) x 72(W) x 50(H)
Outer Carton (cm) 31.5(L) x 23.5(W) x 13.5(H)



LR6-SP4

1.5V AA



Packaging
Shrink 4 pcs/pack
Inner Box 15 packs/box
Outer Carton 180 packs/carton
Gross Weight: 17.8 kg
Volume: 0.0096 cbm

Dimensions
Shrink (mm) 56(W) x 50(H) x 14(D)
Inner Box (mm) 174(L) x 72(W) x 50(H)
Outer Carton (cm) 23.5(L) x 21.5(W) x 19.0(H)



LR03-SP2

1.5V AAA



Packaging
Shrink 2 pcs/pack
Inner Box 20 packs/box
Outer Carton 600 packs/carton
Gross Weight: 14.8 kg
Volume: 0.0083 cbm

Dimensions
Shrink (mm) 20(W) x 44.5(H) x 10(D)
Inner Box (mm) 83(L) x 52(W) x 45(H)
Outer Carton (cm) 29.0(L) x 19.0(W) x 15.0(H)



LR03-SP4

1.5V AAA



Packaging
Shrink 4 pcs/pack
Inner Box 15 packs/box
Outer Carton 300 packs/carton
Gross Weight: 14.7 kg
Volume: 0.0084 cbm

Dimensions
Shrink (mm) 40(W) x 44.5(H) x 10(D)
Inner Box (mm) 125(L) x 52(W) x 45(H)
Outer Carton (cm) 29.0(L) x 20.0(W) x 14.5(H)



LR14-SP2

1.5V C



Packaging
Shrink 2 pcs/pack
Inner Box 6 packs/box
Outer Carton 120 packs/carton
Gross Weight: 16.6 kg
Volume: 0.0123 cbm

Dimensions
Shrink (mm) 52(W) x 50(H) x 26(D)
Inner Box (mm) 107(L) x 81(W) x 56(H)
Outer Carton (cm) 29.5(L) x 22.5(W) x 18.5(H)



LR20-SP2

1.5V D



Packaging
Shrink 2 pcs/pack
Inner Box 6 packs/box
Outer Carton 60 packs/carton
Gross Weight: 16.7 kg
Volume: 0.0122 cbm

Dimensions
Shrink (mm) 66(W) x 61(H) x 33(D)
Inner Box (mm) 137(L) x 103(W) x 68(H)
Outer Carton (cm) 35.5(L) x 15.0(W) x 23.0(H)



6LR61-SP1

9V



Packaging
Shrink 1 pcs/pack
Inner Box 12 packs/box
Outer Carton 240 packs/carton
Gross Weight: 11.4 kg
Volume: 0.0083 cbm

Dimensions
Shrink (mm) 25.5(W) x 48.5(H) x 17.5 (D)
Inner Box (mm) 105(L) x 52(W) x 50(H)
Outer Carton (cm) 29.0(L) x 23.0(W) x 12.5(H)



3LR12-SP1

4.5V



Packaging
Shrink 1 pcs/pack
Inner Box 12 packs/box
Outer Carton 192 packs/carton
Gross Weight: 16.6 kg
Volume: 0.0233 cbm

Dimensions
Shrink (mm) 62(W) x 65.5 (H) x 22 (D)
Inner Box (mm) 188(L) x 90(W) x 65(H)
Outer Carton (cm) 38.5(L) x 20.5(W) x 29.5(H)



LR6-PB24
1.5V AA
 4 260033 150455

Packaging
 Box 24 pcs/pack
 Outer Carton 30 packs/carton
Gross Weight: 18.3 kg
Volume: 0.0178 cbm

Dimensions
Plastic box (mm) 98(L) x 75(W) x 50(H)
Outer Carton (cm) 42.5(L) x 22(W) x 19(H)



LR03-PB24
1.5V AAA
 4 260033 150462

Packaging
 Box 24 pcs/pack
 Outer Carton 30 packs/carton
Gross Weight: 9.0 kg
Volume: 0.0107 cbm

Dimensions
Plastic box (mm) 80(L) x 60(W) x 45(H)
Outer Carton (cm) 34.5(L) x 18.5(W) x 17.0(H)



LR6-PB20
1.5V AA
 4 260216 453106

Packaging
 Box 20 pcs/pack
 Outer Carton 30 packs/carton
Gross Weight: 15.0 kg
Volume: 0.0150 cbm

Dimensions
Plastic box (mm) 82(L) x 75(W) x 50(H)
Outer Carton (cm) 43.0(L) x 19.2(W) x 19.0(H)



LR03-PB20
1.5V AAA
 4 260216 453113

Packaging
 Box 20 pcs/pack
 Outer Carton 30 packs/carton
Gross Weight: 7.8 kg
Volume: 0.0074 cbm

Dimensions
Plastic box (mm) 66(L) x 64(W) x 44(H)
Outer Carton (cm) 34.5(L) x 15.5(W) x 17.5(H)



6LR61-PB6
9V
 4 260033 150479

Packaging
 Box 6 pcs/pack
 Inner Box 6 packs/box
 Outer Carton 24 packs/carton
Gross Weight: 7.8 kg
Volume: 0.0105 cbm

Dimensions
Plastic box (mm) 71(L) x 68(W) x 49(H)
Inner Box (mm) 210(L) x 148(W) x 60(H)
Outer Carton (cm) 31.0(L) x 22.5(W) x 15.0(H)



LR03-PBH24
1.5V AAA
 4 260033 155108

Packaging
 Box 24 pcs/pack
 Inner Box 12 packs/box
 Outer Carton 24 packs/carton
Gross Weight: 8.8 kg
Volume: 0.0067 cbm

Dimensions
Plastic box (mm) 96(L) x 70(W) x 26(H)
Inner Box (mm) 21.5(L) x 200(W) x 55(H)
Outer Carton (cm) 23.0(L) x 21.5(W) x 13.5(H)



LR6-PBH24
1.5V AA
 4 260033 155092

Packaging
 Box 24 pcs/pack
 Inner Box 12 packs/box
 Outer Carton 24 packs/carton
Gross Weight: 16.3 kg
Volume: 0.0116 cbm

Dimensions
Plastic box (mm) 108(L) x 92(W) x 32(H)
Inner Box (mm) 285(L) x 220(W) x 70(H)
Outer Carton (cm) 30.0(L) x 23.5(W) x 16.5(H)



CM-FA-01
 4 260033 155160

Packaging 10 x LR6 + 8 x LR03+
 2 x 6LF22 + 4xC Size Adaptors+
 4 x D Size Adaptors+BT-0503
 Outer Carton 10 boxes/carton
Gross Weight: 8.0 kg
Volume: 0.0195 cbm

Dimensions
Plastic box (mm) 255(L) x 173(W) x 37(H)
Outer Carton (cm) 35.5(L) x 20.0(W) x 27.5(H)

Shrink Wrap Packaging and Display Boxes

Handy Packaging!

Our shrink wrap packaging and display boxes help keep your batteries where you need them, with minimum fuss.

- Convenient, portable and durable
- Self-standing, sturdy display boxes
- Many sizes and shapes available
- Securely hold several batteries
- Professional, branded card inserts and designs for effective messaging



LR6-SP10-DA

1.5V AA



4 260033 157249

Packaging

Blister 10 pcs/pack
Inner Box 24 packs/box
Outer Carton 2 boxes/carton

Gross Weight: 14.0 kg
Volume: 0.0087 cbm

Dimensions

Inner Box (mm) 150(L) x 190(W) x 108(H)
Outer Carton (cm) 32.0(L) x 20.5(W) x 12.5(H)



LR03-SP10-DA

1.5V AAA



4 260033 157256

Packaging

Blister 10 pcs/pack
Inner Box 20 packs/box
Outer Carton 4 boxes/carton

Gross Weight: 12.0 kg
Volume: 0.0075 cbm

Dimensions

Inner Box (mm) 110(L) x 120(W) x 96(H)
Outer Carton (cm) 26.0(L) x 24.0(W) x 11.0(H)



LR6-SP10+2-DA

1.5V AA



4 260216 455643

Packaging

Blister 12 pcs/pack
Inner Box 20 packs/box
Outer Carton 2 boxes/carton

Gross Weight: 11.8 kg
Volume: 0.0079 cbm

Dimensions

Inner Box (mm) 175(L) x 150(W) x 110(H)
Outer Carton (cm) 31.5(L) x 19.0(W) x 13.2(H)



LR03-SP10+2-DA

1.5V AAA



4 260216 455650

Packaging

Blister 12 pcs/pack
Inner Box 20 packs/box
Outer Carton 4 boxes/carton

Gross Weight: 11.8 kg
Volume: 0.0075 cbm

Dimensions

Inner Box (mm) 130(L) x 110(W) x 100(H)
Outer Carton (cm) 23.5(L) x 14.5(W) x 22.0(H)

Limited edition

Value pack for limited campaign



8+4LR6-BP

1.5V AA



Packaging

Shrink 12 pcs/pack
 Inner Box 6 packs/box
 Outer Carton 48 packs/carton

Gross Weight: 15.0 kg
 Volume: 0.0190 cbm

Dimensions

Shrink (mm) 125(W) x 114(H) x 29(D)
 Inner Box (mm) 132(L) x 100(W) x 137(H)
 Outer Carton (cm) 29.5(L) x 28.5(W) x 22.5(H)



8+4LR03-BP

1.5V AAA



Packaging

Shrink 12 pcs/pack
 Inner Box 6 packs/box
 Outer Carton 72 packs/carton

Gross Weight: 12.2 kg
 Volume: 0.0207 cbm

Dimensions

Shrink (mm) 125(W) x 114(H) x 21(D)
 Inner Box (mm) 132(L) x 75(W) x 125(H)
 Outer Carton (cm) 41.5(L) x 28.5(W) x 17.5(H)

DR-16 (8+4)



DR16 Promotion Display "8+4 free"

- Plus Alkaline floor display for promotion blister "8+4 free" (AA | AAA)
- Height (total) 1,17m + pallet
- Width 0,55m
- Depth 0,38m
- Material Cardboard
- Surface shiny
- 12x grids = 12 storage compartments
- 48x LR6 „8+4 free“ (8 storage compartments)
6 blister per storage compartment
- 36 x LR03 „8+4 free“ (4 storage compartments)
- 84 blister total

Super Heavy Duty Batteries

Camelion Zinc Carbon batteries are a great choice for small household electronic devices that need continuous power such as clocks, flashlights, remote controls and transistor radios. Manganese dioxide is used for the positive material and zinc/ammonium chloride for the electrolyte in a leakage proof structure. These, general purpose, batteries offer a long shelf life as well as reliability, versatility and savings.



R20P-BP2B

1.5V D



Packaging		Gross Weight:
Blister	2 pcs/pack	14.9 kg
Inner Box	6 packs/box	Volume:
Outer Carton	72 packs/carton	0.0238 cbm

Dimensions	
Blister (mm)	84(W) x 114(H) x 34(D)
Inner Box (mm)	160(L) x 110(W) x 92(H)
Outer Carton (cm)	33.5(L) x 29.0(W) x 24.5(H)



R14P-BP2B

1.5V C



Packaging		Gross Weight:
Blister	2 pcs/pack	15.6 kg
Inner Box	6 packs/box	Volume:
Outer Carton	144 packs/carton	0.0315 cbm

Dimensions	
Blister (mm)	84(W) x 114(H) x 27(D)
Inner Box (mm)	137(L) x 86(W) x 86(H)
Outer Carton (cm)	37.5(L) x 29.5(W) x 28.5(H)



R6P-BP4B

1.5V AA



Packaging		Gross Weight:
Blister	4 pcs/pack	17.5 kg
Inner Box	12 packs/box	Volume:
Outer Carton	240 packs/carton	0.0272cbm

Dimensions	
Blister (mm)	84(W) x 114(H) x 15(D)
Inner Box (mm)	131(L) x 98(W) x 86(H)
Outer Carton (cm)	45.0(L) x 27.5(W) x 22.0(H)



R03P-BP4B

1.5V AAA



Packaging		Gross Weight:
Blister	4 pcs/pack	14.6 kg
Inner Box	12 packs/box	Volume:
Outer Carton	288 packs/carton	0.0237cbm

Dimensions	
Blister (mm)	84(W) x 114(H) x 11(D)
Inner Box (mm)	119(L) x 75(W) x 86(H)
Outer Carton (cm)	32.5(L) x 26.0(W) x 28.0(H)



R6P-HP12B

1.5V AA



Packaging		Gross Weight:
Blister	12 pcs/pack	9.3 kg
Outer Carton	48 packs/carton	Volume:
		0.0098cbm

Dimensions	
Blister (mm)	170(W) x 100(H) x 15(D)
Outer Carton (cm)	23.5(L) x 25.5(W) x 20.5(H)



6F22-BP1B

9V



Packaging		Gross Weight:
Blister	1 pcs/pack	11.4 kg
Inner Box	12 packs/box	Volume:
Outer Carton	240 packs/carton	0.0310 cbm

Dimensions	
Blister (mm)	84(W) x 114(H) x 18(D)
Inner Box (mm)	123(L) x 117(W) x 86(H)
Outer Carton (cm)	45.0(L) x 27.0(W) x 25.5(H)



4R25-SP1B

6V



Packaging		Gross Weight:
Shrink	1 pcs/pack	6.7 kg
Inner Box	6 packs/box	Volume:
Outer Carton	12 packs/carton	0.0090 cbm

Dimensions	
Shrink (mm)	68.2(W) x 68.2(H) x 115 (D)
Inner Box (mm)	205(L) x 135(W) x 120(H)
Outer Carton (cm)	29.0(L) x 22.0(W) x 14.0(H)



R20P-BP2G
1.5V D
 Packaging 4 260033 156280
 Blister 2 pcs/pack Gross Weight: 14.3 kg
 Inner Box 6 packs/box Volume:
 Outer Carton 72 packs/carton 0.0238cbm
 Dimensions
 Blister (mm) 84(W) x 114(H) x 34(D)
 Inner Box (mm) 160(L) x 110(W) x 92(H)
 Outer Carton (cm) 33.5(L) x 29.0(W) x 24.5(H)



R20P-BP4G
1.5V D
 Packaging 4 260033 156358
 Blister 4 pcs/pack Gross Weight: 20.6 kg
 Inner Box 6 packs/box Volume:
 Outer Carton 54 packs/carton 0.0340cbm
 Dimensions
 Blister (mm) 84(W) x 190(H) x 34(D)
 Inner Box (mm) 290(L) x 110(W) x 90(H)
 Outer Carton (cm) 31.0(L) x 30.5(W) x 36.0(H)



R14P-BP2G
1.5V C
 Packaging 4 260033 156297
 Blister 2 pcs/pack Gross Weight: 14.9 kg
 Inner Box 6 packs/box Volume:
 Outer Carton 144 packs/carton 0.0315 cbm
 Dimensions
 Blister (mm) 84(W) x 114(H) x 27(D)
 Inner Box (mm) 137(L) x 86(W) x 86(H)
 Outer Carton (cm) 37.5(L) x 29.5(W) x 28.5(H)



R14P-BP4G
1.5V C
 Packaging 4 260033 156389
 Blister 4 pcs/pack Gross Weight: 10.4 kg
 Inner Box 6 packs/box Volume:
 Outer Carton 54 packs/carton 0.0245cbm
 Dimensions
 Blister (mm) 84(W) x 165(H) x 27(D)
 Inner Box (mm) 240(L) x 90(W) x 90(H)
 Outer Carton (cm) 32.0(L) x 25.5(W) x 30.0(H)



R14P-BP6G
1.5V C
 Packaging 4 260033 150936
 Blister 6 pcs/pack Gross Weight: 15 kg
 Inner Box 4 packs/box Volume:
 Outer Carton 48 packs/carton 0.0336 cbm
 Dimensions
 Blister (mm) 84(W) x 210(H) x 27(D)
 Inner Box (mm) 220(L) x 110(W) x 90(H)
 Outer Carton (cm) 46.5(L) x 24.5(W) x 29.5(H)



R6P-BP8G
1.5V AA
 Packaging 4 260033 156402
 Blister 8 pcs/pack Gross Weight: 9.5 kg
 Inner Box 12 packs/box Volume:
 Outer Carton 72 packs/carton 0.0198 cbm
 Dimensions
 Blister (mm) 84(W) x 165(H) x 15(D)
 Inner Box (mm) 265(L) x 100(W) x 90(H)
 Outer Carton (cm) 31.5(L) x 28.0(W) x 22.5(H)



R6P-BP4G
1.5V AA
 Packaging 4 260033 156303
 Blister 4 pcs/pack Gross Weight: 16.3 kg
 Inner Box 12 packs/box Volume:
 Outer Carton 240 packs/carton 0.0272cbm
 Dimensions
 Blister (mm) 84(W) x 114(H) x 15(D)
 Inner Box (mm) 131(L) x 98(W) x 86(H)
 Outer Carton (cm) 45.0(L) x 27.5(W) x 22.0(H)



R6P-BP10G
1.5V AA
 Packaging 4 260033 156396
 Blister 10 pcs/pack Gross Weight: 12.1 kg
 Inner Box 12 packs/box Volume:
 Outer Carton 72 packs/carton 0.0239 cbm
 Dimensions
 Blister (mm) 84(W) x 190(H) x 15(D)
 Inner Box (mm) 315(L) x 104(W) x 90(H)
 Outer Carton (cm) 33.0(L) x 31.5(W) x 23.0(H)



R03P-BP4G
1.5V AAA
 Packaging 4 260033 156327
 Blister 4 pcs/pack Gross Weight: 12.0 kg
 Inner Box 12 packs/box Volume:
 Outer Carton 288 packs/carton 0.0237cbm
 Dimensions
 Blister (mm) 84(W) x 114(H) x 11(D)
 Inner Box (mm) 119(L) x 75(W) x 86(H)
 Outer Carton (cm) 32.5(L) x 26.0(W) x 28.0(H)



R03P-BP8G
1.5V AAA
 Packaging 4 260033 156426
 Blister 8 pcs/pack Gross Weight: 6.6 kg
 Inner Box 12 packs/box Volume:
 Outer Carton 72 packs/carton 0.0132 cbm
 Dimensions
 Blister (mm) 84(W) x 165(H) x 11(D)
 Inner Box (mm) 200(L) x 84(W) x 90(H)
 Outer Carton (cm) 30.0(L) x 22.0(W) x 20.0(H)



6F22-BP1G
9V
 Packaging 4 260033 156341
 Blister 1 pcs/pack **Gross Weight:** 11.4 kg
 Inner Box 12 packs/box **Volume:** 0.0310 cbm
 Outer Carton 240 packs/carton
Dimensions
 Blister (mm) 84(W) x 114(H) x 18(D)
 Inner Box (mm) 123(L) x 117(W) x 86(H)
 Outer Carton (cm) 45.0(L) x 27.0(W) x 25.5(H)



6F22-BP2G
9V
 Packaging 4 260033 156365
 Blister 2 pcs/pack **Gross Weight:** 18.3 kg
 Inner Box 12 packs/box **Volume:** 0.0310 cbm
 Outer Carton 192 packs/carton
Dimensions
 Blister (mm) 84(W) x 114(H) x 18(D)
 Inner Box (mm) 123(L) x 117(W) x 86(H)
 Outer Carton (cm) 36.2(L) x 26.3(W) x 25.8(H)



3R12-BP1G
4.5V
 Packaging 4 260033 156372
 Blister 1 pcs/pack **Gross Weight:** 15.4 kg
 Inner Box 6 packs/box **Volume:** 0.0290 cbm
 Outer Carton 144 packs/carton
Dimensions
 Blister (mm) 84(W) x 114(H) x 23(D)
 Inner Box (mm) 160(L) x 75(W) x 86(H)
 Outer Carton (cm) 33.5(L) x 31.5(W) x 27.5(H)



2R10-BP1G
3V
 Packaging 4 260033 150943
 Blister 1 pcs/pack **Gross Weight:** 11.0 kg
 Inner Box 12 packs/box **Volume:** 0.0533 cbm
 Outer Carton 240 packs/carton
Dimensions
 Blister (mm) 84(W) x 124(H) x 14(D)
 Inner Box (mm) 156(L) x 115(W) x 125(H)
 Outer Carton (cm) 59.5(L) x 28.0(W) x 32.0(H)



R20P-SP2G
1.5V D
 Packaging 4 260033 156433
 Shrink 2 pcs/pack **Gross Weight:** 17.5 kg
 Inner Box 6 packs/box **Volume:** 0.0169 cbm
 Outer Carton 96 packs/carton
Dimensions
 Shrink (mm) 66(W) x 61(H) x 33(D)
 Inner Box (mm) 137(L) x 103(W) x 68(H)
 Outer Carton (cm) 28.5(L) x 22.0(W) x 27.0(H)



R14P-SP2G
1.5V C
 Packaging 4 260033 156440
 Shrink 2 pcs/pack **Gross Weight:** 13.2 kg
 Inner Box 6 packs/box **Volume:** 0.0129 cbm
 Outer Carton 144 packs/carton
Dimensions
 Shrink (mm) 52(W) x 50(H) x 26(D)
 Inner Box (mm) 104(L) x 78(W) x 50(H)
 Outer Carton (cm) 25.5(L) x 23.0(W) x 22.0(H)



R6P-SP2G
1.5V AA
 Packaging 4 260033 156464
 Shrink 2 pcs/pack **Gross Weight:** 15.5 kg
 Inner Box 30 packs/box **Volume:** 0.0127 cbm
 Outer Carton 480 packs/carton
Dimensions
 Shrink (mm) 28(W) x 50(H) x 14(D)
 Inner Box (mm) 113(L) x 72(W) x 50(H)
 Outer Carton (cm) 30.5(L) x 22.0(W) x 19.0(H)



R6P-SP4G
1.5V AA
 Packaging 4 260033 156457
 Shrink 4 pcs/pack **Gross Weight:** 14.7 kg
 Inner Box 15 packs/box **Volume:** 0.0127 cbm
 Outer Carton 240 packs/carton
Dimensions
 Shrink (mm) 56(W) x 50(H) x 14(D)
 Inner Box (mm) 174(L) x 72(W) x 50(H)
 Outer Carton (cm) 30.5(L) x 22.0(W) x 19.0(H)



R03P-SP2G
1.5V AAA
 Packaging 4 260033 156488
 Shrink 2 pcs/pack **Gross Weight:** 9.5 kg
 Inner Box 30 packs/box **Volume:** 0.0083 cbm
 Outer Carton 600 packs/carton
Dimensions
 Shrink (mm) 40(W) x 44.5(H) x 10(D)
 Inner Box (mm) 83(L) x 52(W) x 45(H)
 Outer Carton (cm) 28.5(L) x 20.0(W) x 14.5(H)



R03P-SP4G
1.5V AAA
 Packaging 4 260033 156471
 Shrink 4 pcs/pack **Gross Weight:** 10.0 kg
 Inner Box 15 packs/box **Volume:** 0.0083 cbm
 Outer Carton 300 packs/carton
Dimensions
 Shrink (mm) 40(W) x 44.5(H) x 10(D)
 Inner Box (mm) 125(L) x 52(W) x 45(H)
 Outer Carton (cm) 28.5(L) x 20.0(W) x 14.5(H)



6F22-SP1G

9V



Packaging
 Shrink 1 pcs/pack
 Inner Box 12 packs/box
 Outer Carton 480 packs/carton

Gross Weight: 19.0 kg
Volume: 0.0144 cbm

Dimensions
 Shrink (mm) 25.5(W) x 48.5(H) x 17.5 (D)
 Inner Box (mm) 105(L) x 52(W) x 50(H)
 Outer Carton (cm) 29.0(L) x 22.5(W) x 22.0(H)



4R25-SP1G

6V



Packaging
 Shrink 1 pcs/pack
 Inner Box 6 packs/box
 Outer Carton 12 packs/carton

Gross Weight: 6.7 kg
Volume: 0.0090 cbm

Dimensions
 Shrink (mm) 68.5(W) x 68.5(H) x 115 (D)
 Inner Box (mm) 205(L) x 135(W) x 120(H)
 Outer Carton (cm) 29.0(L) x 22.0(W) x 14.0(H)



3R12-SP1G

4.5V



Packaging
 Shrink 1 pcs/pack
 Inner Box 12 packs/box
 Outer Carton 144 packs/carton

Gross Weight: 16.6 kg
Volume: 0.0188 cbm

Dimensions
 Shrink (mm) 62(W) x 65.5 (H) x 22 (D)
 Inner Box (mm) 188(L) x 90(W) x 65(H)
 Outer Carton (cm) 39.0(L) x 21.0(W) x 23.0(H)



FPG-GB40



Packaging 4 x R14P+24 x R6+
 12 x R03P+
 1 x SL3013(Blue 3LR44)

Gross Weight: 13.0 kg
Volume: 0.0223 cbm

Box (mm) 132(B) x 126(T) x 54(H)
Outer Carton (cm) 40.0 (L) x 28.0(W) x 19.5(H)



4+2R6PG-BP

1.5V AA



Packaging
 Blister 6 pcs/pack
 Inner Box 12 packs/box
 Outer Carton 72 packs/carton

Gross Weight: 7.5 kg
Volume: 0.0160 cbm

Dimensions
 Blister (mm) 125(W) x 114(H) x 15(D)
 Inner Box (mm) 132(L) x 105(W) x 138(H)
 Outer Carton (cm) 41.5(L) x 29.5(W) x 13.5(H)



4+2R03PG-BP

1.5V AAA



Packaging
 Blister 6 pcs/pack
 Inner Box 12 packs/box
 Outer Carton 144 packs/carton

Gross Weight: 9.2 kg
Volume: 0.0207 cbm

Dimensions
 Blister (mm) 125(W) x 114(H) x 11(D)
 Inner Box (mm) 132(L) x 75(W) x 125(H)
 Outer Carton (cm) 41.5(L) x 28.5(W) x 17.5(H)



R6P-SP8G

1.5V AA



Packaging
 Shrink 8 pcs/pack
 Inner Box 20 packs/box
 Outer Carton 6 boxes/carton

Gross Weight: 14.7 kg
Volume: 0.0147 cbm

Dimensions
 Inner Box (mm) 150(L) x 118(W) x 110(H)
 Outer Carton (cm) 34.5(L) x 25.0(W) x 17.0(H)



R03P-SP8G

1.5V AAA



Packaging
 Shrink 8 pcs/pack
 Inner Box 40 packs/box
 Outer Carton 6 boxes/carton

Gross Weight: 15.3 kg
Volume: 0.0141 cbm

Dimensions
 Inner Box (mm) 170(L) x 110(W) x 100(H)
 Outer Carton (cm) 31.5(L) x 23.5(W) x 19.0(H)



R6P-SP12G

1.5V AA



Packaging
 Shrink 12 pcs/pack
 Inner Box 6 packs/box
 Outer Carton 8 boxes/carton

Gross Weight: 16.5 kg
Volume: 0.0127 cbm

Dimensions
 Inner Box (mm) 175(L) x 150(W) x 110(H)
 Outer Carton (cm) 31.5(L) x 19.0(W) x 24.0(H)



R03P-SP12G

1.5V AAA



Packaging
 Shrink 12 pcs/pack
 Inner Box 20 packs/box
 Outer Carton 8 boxes/carton

Gross Weight: 14.8 kg
Volume: 0.0143 cbm

Dimensions
 Inner Box (mm) 130(L) x 110(W) x 100(H)
 Outer Carton (cm) 27.5(L) x 23.5(W) x 22.0(H)



Photo Lithium Batteries

Camelion Photo batteries are ideal for a wide range of analog cameras.



CR123A-BP1

3V



Packaging

Blister	1 pcs/pack	Gross Weight:	5.5 kg
Inner Box	10 packs/box	Volume:	0.0243 cbm
Outer Carton	200 packs/carton		

Dimensions

Blister (mm)	84(W) x 114(H) x 17.5(D)
Inner Box (mm)	118(L) x 95(W) x 85(H)
Outer Carton (cm)	45.0(L) x 25.0(W) x 21.5(H)



CR123A-BP2

3V



Packaging

Blister	2 pcs/pack	Gross Weight:	8.6 kg
Inner Box	10 packs/box	Volume:	0.0242 cbm
Outer Carton	200 packs/carton		

Dimensions

Blister (mm)	84(W) x 114(H) x 18(D)
Inner Box (mm)	118(L) x 95(W) x 85(H)
Outer Carton (cm)	45.0(L) x 25.0(W) x 21.5(H)



CR-P2-BP1

6V



Packaging

Blister	1 pcs/pack	Gross Weight:	10.0 kg
Inner Box	10 packs/box	Volume:	0.0265 cbm
Outer Carton	200 packs/carton		

Dimensions

Blister (mm)	84(W) x 114(H) x 20.5(D)
Inner Box (mm)	118(L) x 105(W) x 85(H)
Outer Carton (cm)	45.0(L) x 25.0(W) x 23.5(H)



2CR5-BP1

6V



Packaging

Blister	1 pcs/pack	Gross Weight:	10.0 kg
Inner Box	10 packs/box	Volume:	0.0265 cbm
Outer Carton	200 packs/carton		

Dimensions

Blister (mm)	84(W) x 114(H) x 18(D)
Inner Box (mm)	118(L) x 105(W) x 85(H)
Outer Carton (cm)	45.0(L) x 25.0(W) x 23.5(H)



CR2-BP1

3V



Packaging

Blister	1 pcs/pack	Gross Weight:	4.5 kg
Inner Box	10 packs/box	Volume:	0.0215 cbm
Outer Carton	200 packs/carton		

Dimensions

Blister (mm)	84(W) x 114(H) x 16.5(D)
Inner Box (mm)	118(L) x 85(W) x 85(H)
Outer Carton (cm)	45.0(L) x 25.0(W) x 19.0(H)

Electronic Button Cells

Camelion Electronic Button Cells provide stable energy for small electronic devices and are available in lithium, alkaline, silver oxide and zinc air chemistries, depending upon voltage and size requirements of your equipment. They are suitable for car keys, calculators, laser pointers, hearing aids and many other electronic gadgets.



Electronics **Lithium** **3V**



ITEM	EAN	PACKAGING WxHxD(mm)	INNER BOX LxWxH(mm)	SHIPPING CARTON LxWxH(cm)	G.W.(KG)	VOLUME(CBM)
CR1216-BP1	4260033152831	56 x 92 x 3 1 PC / BLISTER	98 x 37 x 58 10 PACKS	45.5 x 31.5 x 31.5 1800 PACKS	9.5	0.0451
CR1220-BP1	4260033152824				8.0	
CR1225-BP1	4260033152817				8.0	
CR1616-BP1	4260033152800				8.0	
CR1620-BP1	4260033152794				8.5	
CR1632-BP1	4260033152923				10.4	
CR2016-BP1	4260033152787				9.5	
CR2025-BP1	4260033152770				11.0	
CR2032-BP1	4260033152763				12.0	
CR2320-BP1	4260033152756				11.5	
CR2325-BP1	4260033152848				12.0	
CR2330-BP1	4260033152749				13.0	
CR2430-BP1	4260033152732				13.5	
CR2450-BP1	4260033152725				17.5	
CR2477-BP1	4260216455353				17.72	
CR927-BP1	4260216452475				14.0	
CR1216-BP5	4260033152718	55x 190 x 3 5 PCS / BLISTER	195 x 90 x 58 30 PACKS	29.0 x 22.0 x 26.0 360 PACKS	4.5	0.0165
CR1220-BP5	4260033152701				4.5	
CR1225-BP5	4260033152695				5.0	
CR1616-BP5	4260033152688				5.5	
CR1620-BP5	4260033152671				5.5	
CR1632-BP5	4260216455797				6.5	
CR2016-BP5	4260033152664				8.0	
CR2025-BP5	4260033152657				9.0	
CR2032-BP5	4260033152640				5.5	
CR2430-BP5	4260216455803				12.2	
CR2450-BP5	4260216455810	16.7				
CRVP01-BP6	4260216456145	125x114x6.5 6 PCS / BLISTER	138 x 85 x 127 24 PACKS	29.5 x 27.5 x 28.0 288 PACKS	8.0	0.0227



Electronics Alkaline

1.5V

0% Hg



ITEM(0%Hg)	EAN	PACKAGING WxHxD(mm)	INNER BOX LxWxH(mm)	SHIPPING CARTON LxWxH(cm)	G. W. (KG)	VOLUME (CBM)
AG1-BP2(0%Hg)	4260216454783	56 x 92 x 5 2 PC / BLISTER	95 x 63 x 58 20 PACKS	39.5 x 30.5 x 31.5 1800 PACKS	7.0	0.0379
AG2-BP2(0%Hg)	4260216454790				7.8	
AG3-BP2(0%Hg)	4260216454806				8.0	
AG4-BP2(0%Hg)	4260216454622				7.0	
AG5-BP2(0%Hg)	4260216454813	56 x 92 x 7 2 PC / BLISTER	98 x 73 x 58 20 PACKS	45.5 x 31.5 x 31.5 1800 PACKS	9.0	0.0451
AG6-BP2(0%Hg)	4260216454820	56 x 92 x 5 2 PC / BLISTER	95 x 63 x 58 20 PACKS	39.5 x 30.5 x 31.5 1800 PACKS	8.0	0.0379
AG7-BP2(0%Hg)	4260216454837				8.5	
AG8-BP2(0%Hg)	4260216454844				9.0	
AG9-BP2(0%Hg)	4260216454851				9.0	
AG10-BP2(0%Hg)	4260216454608				10.0	
AG11-BP2(0%Hg)	4260216454868				7.0	
AG12-BP2(0%Hg)	4260216454875	56 x 92 x 7 2 PC / BLISTER	98 x 73 x 58 20 PACKS	45.5 x 31.5 x 31.5 1800 PACKS	11.0	0.0451
AG13-BP2(0%Hg)	4260216454615	13.0				
625A-BP1(0%Hg)	4260216454882	56 x 92 x 7 1 PC / BLISTER	146 x 98 x 58 40 PACKS	45.5 x 31.5 x 31.5 1800 PACKS	18.0	0.0451
AG0-BP10(0%Hg)	4260216454899	50x 160 x 5 10 PCS / BLISTER	170 x 40 x 52 20 PACKS	50.0 x 20.0 x 20.0 360 PACKS	4.0	0.0198
AG1-BP10(0%Hg)	4260216454905				4.0	
AG2-BP10(0%Hg)	4260216454912				4.5	
AG3-BP10(0%Hg)	4260216454929				5.0	
AG4-BP10(0%Hg)	4260216454400				4.0	
AG5-BP10(0%Hg)	4260216454936				6.5	
AG6-BP10(0%Hg)	4260216454943				5.0	
AG7-BP10(0%Hg)	4260216454950				5.5	
AG8-BP10(0%Hg)	4260216454967				6.0	
AG9-BP10(0%Hg)	4260216454974				6.0	
AG10-BP10(0%Hg)	4260216454981				7.0	
AG11-BP10(0%Hg)	4260216454998				4.0	
AG12-BP10(0%Hg)	4260216455001				8.7	
AG13-BP10(0%Hg)	4260216455018				10.0	

0% Hg



Industrial Classifications

AG0	LR521	G0			379
AG1	LR621	G1	LR60	164	364
AG2	LR726	G2	LR59	196	396
AG3	LR41	G3	LR41	192	392
AG4	LR626	G4	LR66	177	377
AG5	LR754	G5	LR48	193	393
AG6	LR921	G6	LR69	171	371
AG7	LR926	G7	LR57	195	395
AG8	LR1120	G8	LR55	191	391
AG9	LR936	G9	LR45	194	394
AG10	LR1130	G10	LR54	189	389
AG11	LR721	G11	LR58	162	362
AG12	LR43	G12	LR43	186	386
AG13	LR44	G13	LR44	A76	357

Remote Control Batteries

6V/12V



ITEM(0% Hg)	EAN	Voltage (V)	PACKAGING WxHxD(mm)	INNER BOX LxWxH(mm)	SHIPPING CARTON LxWxH(cm)	G. W. (KG)	VOLUME (CBM)
A11-BP1(0%Hg)	4260216455049	6V	56 x 92 x 10 1 PC / BLISTER	125 x 95 x 58 20 PACKS	39.5 x 30.5 x 31.5 900 PACKS	7.6	0.0380
A23-BP1(0%Hg)	4260216455056	12V				8.6	
A27-BP1(0%Hg)	4260216455063	12V				8.0	
LR32A-BP1(0%Hg)	4260216455070	9V				6.0	
A23-BP5(0%Hg)	4260216455087	12V	50 x 160 x 10 5 PCS / BLISTER	170 x 65 x 52 10 PACKS	42.0 x 36.0 x 18.0 360 PACKS	18.0	0.0273
A27-BP5(0%Hg)	4260216455094	12V				12.0	



4LR44-BP1C(0%Hg)

6V



Packaging
Blister 1 pcs/pack
Inner Box 20 packs/box
Outer Carton 900 packs/carton
Gross Weight: 15.0 kg
Volume: 0.0451 cbm

Dimensions
Blister (mm) 56(W)x 92(H) x (D)
Inner Box (mm) 145(L)x 95(W) x 58(H)
Outer Carton (cm) 45.5(L)x 31.5(W) x 31.5(H)



4LR44-BP5(0%Hg)

6V



Packaging
Blister 5 pcs/pack
Inner Box 6 packs/box
Outer Carton 192 packs/carton
Gross Weight: 13.2 kg
Volume: 0.0150 cbm

Dimensions
Blister (mm) 50(W) x 160(H) x (D)
Inner Box (mm) 170(L) x 78(W) x 52(H)
Outer Carton (cm) 33.5(L) x 19.0(W) x 23.5(H)



4LR43-BP1(0%Hg)

6V



Packaging
Blister 1 pcs/pack
Inner Box 20 packs/box
Outer Carton 900 packs/carton
Gross Weight: 15.0 kg
Volume: 0.0451 cbm

Dimensions
Blister (mm) 56(W)x 92(H) x (D)
Inner Box (mm) 145(L)x 95(W) x 58(H)
Outer Carton (cm) 45.5(L)x 31.5(W) x 31.5(H)

Industrial Classifications

SG0	SR521	G0	SR63	379
SG1	SR621	G1	SR60	364
SG2	SR726	G2	SR59	396
SG3	SR41	G3	SR41	392
SG4	SR626	G4	SR66	377
SG5	SR754	G5	SR48	393
SG6	SR921	G6	SR69	371
SG7	SR926	G7	SR57	395
SG8	SR1120	G8	SR55	391
SG9	SR936	G9	SR45	394
SG10	SR1130	G10	SR54	389
SG11	SR721	G11	SR58	362
SG12	SR43	G12	SR43	386
SG13	SR44	G13	SR44	357

Electronics Silver Oxide 1.55V

0% Hg



ITEM(0% Hg)	EAN	PACKAGING WxHxD(mm)	INNER BOX LxWxH(mm)	SHIPPING CARTON LxWxH(cm)	G. W. (KG)	VOLUME (CBM)
SR41-BP1(0%Hg)	4260216455117	55x 92 x 5 1 PC / BLISTER	145 x 95 x 58 40 PACKS	45.5 x 31.5 x 31.5 1800 PACKS	8.5	0.0451
SR43-BP1(0%Hg)	4260216455124				10.5	
SR44-BP1(0%Hg)	4260216455131				11.5	
SR54-BP1(0%Hg)	4260216455148				9.5	
SR57-BP1(0%Hg)	4260216455155				8.5	
SR58-BP1(0%Hg)	4260216455162				8	
SR59-BP1(0%Hg)	4260216455179				8	
SR60-BP1(0%Hg)	4260216455186				8	
SR63-BP1(0%Hg)	4260216455193				7.5	
SR66-BP1(0%Hg)	4260216455209				8	
SR69-BP1(0%Hg)	4260216455216	9.5				
SR41-BP5(0%Hg)	4260216455223	55x 190 x 5 5 PCS / BLISTER	195 x 90 x 58 20 PACKS	37.0 x 21.7 x 29.5 360 PACKS	4.5	0.0237
SR43-BP5(0%Hg)	4260216455230				6.5	
SR44-BP5(0%Hg)	4260216455247				7.5	
SR54-BP5(0%Hg)	4260216455254				5.5	
SR57-BP5(0%Hg)	4260216455261				4.5	
SR58-BP5(0%Hg)	4260216455278				4	
SR59-BP5(0%Hg)	4260216455285				4	
SR60-BP5(0%Hg)	4260216455292				4	
SR63-BP5(0%Hg)	4260216455308				3.5	
SR66-BP5(0%Hg)	4260216455315				4	
SR69-BP5(0%Hg)	4260216455322	5.5				

0% Hg



4SR44-BP1C(0% Hg)

6.2V



Packaging		Gross Weight: 15.0 kg
Blister	1 pcs/pack	
Inner Box	20 packs/box	Volume: 0.0451 cbm
Outer Carton	900 packs/carton	
Dimensions		
Blister (mm)	55(W)x 92(H) x 5(D)	
Inner Box (mm)	145(L)x 95(W) x 58(H)	
Outer Carton (cm)	45.5(L)x 31.5(W) x 31.5(H)	

0% Hg



4SR44-Bulk

6.2V

Packaging		Gross Weight: 14.6 kg
Inner Box	32 packs/box	
Outer Carton	1280 packs/carton	Volume: 0.0104 cbm
Dimensions		
Inner Box (mm)	102(L)x 52(W) x 30(H)	
Outer Carton (cm)	24(L)x 23.5(W) x 18.5(H)	

Zinc Air 1.4V

Camelion Hearing Aid batteries are light and reliable. They are conveniently packaged to make them easy to use.



ITEM	EAN	WxHxD (mm)	PACKAGING	WxHxD (mm)	INNER BOX	WxHxD (mm)	INNER CARTON	WxHxD (cm)	SHIPPING CARTON	G. W. (KG)	VOLUME (CBM)
A13-BP6(0%Hg)	4260216454417	48 x 90 x 6.5	6PCS/Blister	92 x42 x 50	10 Packs	245 x 120 x 130	100 Packs	62 x 26 x 15	500 Packs	6.5	0.0242
A10-BP6(0%Hg)	4260216454486	48 x 90 x 4.5	6PCS/Blister	92 x32 x 50	10 Packs	195 x 120 x 130	100 Packs	62 x 21 x 15	500 Packs	6.0	0.0196
A675-BP6(0%Hg)	4260216454493	48 x 90 x 6.5	6PCS/Blister	92 x42 x 50	10 Packs	245 x 120 x 130	100 Packs	62 x 26 x 15	500 Packs	9.5	0.0242
A312-BP6(0%Hg)	4260216454509	48 x 90 x 4.5	6PCS/Blister	92 x32 x 50	10 Packs	195 x 120 x 130	100 Packs	62 x 21 x 15	500 Packs	6.5	0.0196

Battery Adapter



For Rechargeable & Non-Rechargeable Batteries



AA Battery+Adapter

D or C Size



Warning:

When using two or more adapters together, avoid mixing new and used batteries, batteries with different charge levels or different types and brands. Don't mix adapters with actual D batteries in the device. Please insert the AA batteries into the adapter correctly. Remove battery after use, or when not in use. Store adapter separately from battery. Do not recharge battery while in the adapter.

Battery Case

Main Features

- Durable plastic case holds up to 4 AA/AAA batteries.
- Keep your batteries together and safe.

Directions

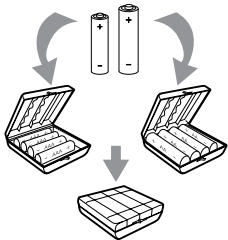

Battery Tester



BT-0503

Tests AA, AAA, C, D, 9V and some models of button cell

MAIN FEATURES

- Quickly determines if battery needs charging or replacing
- On the spot testing – just insert and check LED
- Compact & light

• **Insert battery: Observe polarity**

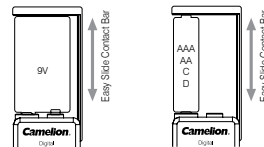

• **Check LED indicator: If LED fluctuates press slightly**

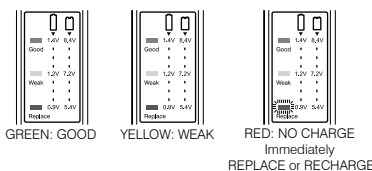

BT-0503



Packaging

















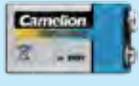

Blister	1 pcs/pack
Inner Box	60 packs/box
Outer Carton	240 packs/carton

Gross Weight:	8.7 kg
Volume:	0.0388 cbm

Dimensions

Blister (mm)	65(W)x 154(H) x 16(D)
Inner Box (cm)	44(L)x 11.5(W) x 16.5(H)
Outer Carton (cm)	45(L)x 34.5(W) x 25(H)

Battery Selection Chart

<p>Lithium P7 Batteries</p> 	
<p>Digi Alkaline Batteries</p> 	
<p>Plus Alkaline Batteries</p> 	
<p>Super Heavy Duty Batteries</p> 	
<p>Photo Lithium Batteries</p> 	
<p>9V Lithium Battery</p> 	
<p>Micro Batteries: Lithium</p> 	
<p>Micro Batteries: Alkaline</p> 	
<p>Hearing Aid Zinc Air</p> 	

Please Note:

These are suggested recommendations only.
 For the most accurate information please refer to your device manufacturer's manual.
 Camelion is not responsible for accidents resulting from the use of this information

Specifications

	Lithium P7		Digi Alkaline		Plus Alkaline							Super Heavy Duty							
	FR6	FR03	LR6	LR03	LR20	LR14	LR6	LR03	LR61	6LF22**	3LR12	R6	R03	R20	R14	6F22**	3R12*	4R25**	R10
Nominal Voltage(V)	1.5	1.5	1.5	1.5	1.5	1.5	1.5	1.5	1.5	9	4.5	1.5	1.5	1.5	1.5	9	4.5	6	1.5
Average Capacity(mAh)	2800	1100	2800	1100	18000	8500	2800	1100	600	190**	2700*	950	460	5600	2400	450	1700	7000	500

20+-2°C, Rated capacity at 25 mA continuous drain, to 0.8V
 * 20+-2°C, Rated capacity at 25 mA continuous drain, to 2.7V
 ** 20+-2°C, Rated capacity at 25 mA continuous drain, to 4.8V

Rechargeable

AlwaysReady™

Ni-MH Always Ready Rechargeable Batteries

The new Camelion AlwaysReady battery is ready to be used right from the package. **It holds the charge for up to a year.** And they can be recharged again and again, saving you money. Are you ready? Try AlwaysReady batteries today!



NH-AA2500ARBP2

1.2V AA		4 260216 453038	
Packaging	2 pcs/pack	Gross Weight:	13.1 kg
Blister	12 packs/box	Volume:	0.0274 cbm
Inner Box	192 packs/carton		
Outer Carton			

Dimensions	
Blister (mm)	90(W) x 117(H) x 15(D)
Inner Box (mm)	134(L) x 104(W) x 97(H)
Outer Carton (cm)	41.0(L) x 29.0(W) x 23.0(H)



NH-9V200ARBP1

9V		4 260033 155221	
Packaging	1 pcs/pack	Gross Weight:	12.0 kg
Blister	12 packs/box	Volume:	0.0385 cbm
Inner Box	240 packs/carton		
Outer Carton			

Dimensions	
Blister (mm)	90(W) x 117(H) x 18(D)
Inner Box (mm)	135(L) x 125(W) x 97(H)
Outer Carton (cm)	51.0(L) x 29.0(W) x 26.0(H)



NH-AA2300ARBP4

1.2V AA		4 260033 154040	
Packaging	4 pcs/pack	Gross Weight:	11.8 kg
Blister	12 packs/box	Volume:	0.0144 cbm
Inner Box	96 packs/carton		
Outer Carton			

Dimensions	
Blister (mm)	90(W) x 117(H) x 15(D)
Inner Box (mm)	134(L) x 104(W) x 97(H)
Outer Carton (cm)	29.0(L) x 21.5(W) x 23.0(H)



NH-AA2300ARBP2

1.2V AA		4 260033 152336	
Packaging	2 pcs/pack	Gross Weight:	12.9 kg
Blister	12 packs/box	Volume:	0.0274 cbm
Inner Box	192 packs/carton		
Outer Carton			

Dimensions	
Blister (mm)	90(W) x 117(H) x 15(D)
Inner Box (mm)	134(L) x 104(W) x 97(H)
Outer Carton (cm)	41.0(L) x 29.0(W) x 23.0(H)



NH-AAA800ARBP4

1.2V AAA		4 260033 152312	
Packaging	4 pcs/pack	Gross Weight:	9.2 kg
Blister	12 packs/box	Volume:	0.0168 cbm
Inner Box	144 packs/carton		
Outer Carton			

Dimensions	
Blister (mm)	90(W) x 117(H) x 11(D)
Inner Box (mm)	125(L) x 84(W) x 97(H)
Outer Carton (cm)	31.0(L) x 27.0(W) x 20.0(H)



NH-AAA800ARBP2

1.2V AAA		4 260033 152305	
Packaging	2 pcs/pack	Gross Weight:	8.4 kg
Blister	12 packs/box	Volume:	0.0269 cbm
Inner Box	240 packs/carton		
Outer Carton			

Dimensions	
Blister (mm)	90(W) x 117(H) x 11(D)
Inner Box (mm)	125(L) x 84(W) x 97(H)
Outer Carton (cm)	51.0(L) x 27.0(W) x 19.5(H)



Energy solutions for Solar powered devices

Camelion Ni-MH rechargeable batteries are perfect solutions for outdoor solar powered equipment. The battery offers a longer life cycle and is outstanding in sustaining its energy when charged by solar powered devices. It is the ideal choice for outdoor equipments such as trail lights.



NH-AA800ARBP2

1.2V AA		
Packaging	4 260216 453236	
Blister	2 pcs/pack	Gross Weight: 12.4 kg
Inner Box	12 packs/box	Volume: 0.0274 cbm
Outer Carton	192 packs/carton	
Dimensions		
Blister (mm)	90(W) x 117(H) x 15(D)	
Inner Box (mm)	134(L) x 104(W) x 97(H)	
Outer Carton (cm)	41.0(L) x 29.0(W) x 23.0(H)	



NH-AA600ARBP4(GSL)

1.2V AA		
Packaging	4 260216 455667	
Blister	4 pcs/pack	Gross Weight: 11.4 kg
Inner Box	12 packs/box	Volume: 0.0144 cbm
Outer Carton	96 packs/carton	
Dimensions		
Blister (mm)	90(W) x 117(H) x 15(D)	
Inner Box (mm)	134(L) x 104(W) x 97(H)	
Outer Carton (cm)	29.0(L) x 21.5(W) x 23.0(H)	



NH-AAA600ARBP4(GSL)

1.2V AAA		
Packaging	4 260216 455674	
Blister	4 pcs/pack	Gross Weight: 8.6 kg
Inner Box	12 packs/box	Volume: 0.0168 cbm
Outer Carton	144 packs/carton	
Dimensions		
Blister (mm)	90(W) x 117(H) x 11(D)	
Inner Box (mm)	125(L) x 84(W) x 97(H)	
Outer Carton (cm)	31.0(L) x 27.0(W) x 20.0(H)	

Ni-MH Rechargeable Batteries



Camelion Ni-MH Rechargeable batteries offer high capacity performance, up to 1000 recharge cycles, and because they are used again and again they help reduce environmental waste. High drain devices such as music players and digital cameras are supported, therefore, you can hear more songs and take more photos.



NH-D1000BP2

1.2V D

Packaging	4	260033	151865
Blister	2 pcs/pack	Gross Weight:	17.0 kg
Inner Box	6 packs/box	Volume:	0.0244 cbm
Outer Carton	48 packs/carton		

Dimensions

Blister (mm)	90(W) x 117(H) x 34(D)
Inner Box (mm)	165(L) x 135(W) x 105(H)
Outer Carton (cm)	43.5(L) x 35.0(W) x 16.0(H)



NH-D7000BP2

1.2V D

Packaging	4	260033	151520
Blister	2 pcs/pack	Gross Weight:	19.0 kg
Inner Box	6 packs/box	Volume:	0.0234 cbm
Outer Carton	60 packs/carton		

Dimensions

Blister (mm)	90(W) x 117(H) x 34(D)
Inner Box (mm)	160(L) x 112(W) x 97(H)
Outer Carton (cm)	34.0(L) x 27.5(W) x 25.0(H)



NH-D2500BP2

1.2V D

Packaging	4	260033	151537
Blister	2 pcs/pack	Gross Weight:	11.2 kg
Inner Box	6 packs/box	Volume:	0.0234 cbm
Outer Carton	60 packs/carton		

Dimensions

Blister (mm)	90(W) x 117(H) x 34(D)
Inner Box (mm)	160(L) x 112(W) x 97(H)
Outer Carton (cm)	34.0(L) x 27.5(W) x 25.0(H)



NH-C3500BP2

1.2V C

Packaging	4	260033	151544
Blister	2 pcs/pack	Gross Weight:	16.8 kg
Inner Box	6 packs/box	Volume:	0.0248 cbm
Outer Carton	96 packs/carton		

Dimensions

Blister (mm)	90(W) x 117(H) x 27(D)
Inner Box (mm)	138(L) x 90(W) x 97(H)
Outer Carton (cm)	41.0(L) x 29.5(W) x 20.5(H)



NH-C2500BP2

1.2V C

Packaging	4	260033	151551
Blister	2 pcs/pack	Gross Weight:	16.0 kg
Inner Box	6 packs/box	Volume:	0.0248 cbm
Outer Carton	96 packs/carton		

Dimensions

Blister (mm)	90(W) x 117(H) x 27(D)
Inner Box (mm)	138(L) x 90(W) x 97(H)
Outer Carton (cm)	41.0(L) x 29.5(W) x 20.5(H)



NH-AA2700BC4

1.2V AA

Packaging	4	260033	151933
Blister	4 pcs/pack	Gross Weight:	13.4 kg
Inner Box	12 packs/box	Volume:	0.0144 cbm
Outer Carton	96 packs/carton		

Dimensions

Blister (mm)	90(W) x 117(H) x 15(D)
Inner Box (mm)	134(L) x 104(W) x 97(H)
Outer Carton (cm)	29.0(L) x 21.5(W) x 23.0(H)



NH-AA2700BC2

1.2V AA

Packaging	4	260033	151926
Blister	2 pcs/pack	Gross Weight:	14.0 kg
Inner Box	12 packs/box	Volume:	0.0274 cbm
Outer Carton	192 packs/carton		

Dimensions

Blister (mm)	90(W) x 117(H) x 15(D)
Inner Box (mm)	134(L) x 104(W) x 97(H)
Outer Carton (cm)	41.0(L) x 29.0(W) x 23.0(H)



NH-AA2500BC4

1.2V AA		
4 260033 151834		
Packaging	4 pcs/pack	Gross Weight:
Blister	12 packs/box	13.0 kg
Inner Box	96 packs/carton	Volume:
Outer Carton		0.0144 cbm
Dimensions		
Blister (mm)	90(W) x 117(H) x 15(D)	
Inner Box (mm)	134(L) x 104(W) x 97(H)	
Outer Carton (cm)	29.0(L) x 21.5(W) x 23.0(H)	



NH-AA2500BC2

1.2V AA		
4 260033 151827		
Packaging	2 pcs/pack	Gross Weight:
Blister	12 packs/box	14.3 kg
Inner Box	192 packs/carton	Volume:
Outer Carton		0.0274 cbm
Dimensions		
Blister (mm)	90(W) x 117(H) x 15(D)	
Inner Box (mm)	134(L) x 104(W) x 97(H)	
Outer Carton (cm)	41.0(L) x 29.0(W) x 23.0(H)	



NH-AA2300BP4

1.2V AA		
4 260033 151742		
Packaging	4 pcs/pack	Gross Weight:
Blister	12 packs/box	12.6 kg
Inner Box	96 packs/carton	Volume:
Outer Carton		0.0144 cbm
Dimensions		
Blister (mm)	90(W) x 117(H) x 15(D)	
Inner Box (mm)	134(L) x 104(W) x 97(H)	
Outer Carton (cm)	29.0(L) x 21.5(W) x 23.0(H)	



NH-AA2300BP2

1.2V AA		
4 260033 151735		
Packaging	2 pcs/pack	Gross Weight:
Blister	12 packs/box	13.9 kg
Inner Box	192 packs/carton	Volume:
Outer Carton		0.0274 cbm
Dimensions		
Blister (mm)	90(W) x 117(H) x 15(D)	
Inner Box (mm)	134(L) x 104(W) x 97(H)	
Outer Carton (cm)	41.0(L) x 29.0(W) x 23.0(H)	



NH-AA2000BP2

1.2V AA		
4 260033 151582		
Packaging	2 pcs/pack	Gross Weight:
Blister	12 packs/box	13.1 kg
Inner Box	192 packs/carton	Volume:
Outer Carton		0.0274 cbm
Dimensions		
Blister (mm)	90(W) x 117(H) x 15(D)	
Inner Box (mm)	134(L) x 104(W) x 97(H)	
Outer Carton (cm)	41.0(L) x 29.0(W) x 23.0(H)	



NH-AA1800BP4

1.2V AA		
4 260033 151612		
Packaging	4 pcs/pack	Gross Weight:
Blister	12 packs/box	11.8 kg
Inner Box	96 packs/carton	Volume:
Outer Carton		0.0144 cbm
Dimensions		
Blister (mm)	90(W) x 117(H) x 15(D)	
Inner Box (mm)	134(L) x 104(W) x 97(H)	
Outer Carton (cm)	29.0(L) x 21.5(W) x 23.0(H)	



NH-AA1800BP2

1.2V AA		
4 260033 151605		
Packaging	2 pcs/pack	Gross Weight:
Blister	12 packs/box	12.7 kg
Inner Box	192 packs/carton	Volume:
Outer Carton		0.0274 cbm
Dimensions		
Blister (mm)	90(W) x 117(H) x 15(D)	
Inner Box (mm)	134(L) x 104(W) x 97(H)	
Outer Carton (cm)	41.0(L) x 29.0(W) x 23.0(H)	



NH-AA1500BP2

1.2V AA		
4 260033 151629		
Packaging	2 pcs/pack	Gross Weight:
Blister	12 packs/box	11.2 kg
Inner Box	192 packs/carton	Volume:
Outer Carton		0.0274 cbm
Dimensions		
Blister (mm)	90(W) x 117(H) x 15(D)	
Inner Box (mm)	134(L) x 104(W) x 97(H)	
Outer Carton (cm)	41.0(L) x 29.0(W) x 23.0(H)	



NH-AAA1100BP4

1.2V AAA



Packaging 4 260033 151957
 Blister 4 pcs/pack
 Inner Box 12 packs/box
 Outer Carton 144 packs/carton
 Gross Weight: 9.8 kg
 Volume: 0.0168 cbm

Dimensions

Blister (mm) 90(W) x 117(H) x 11(D)
 Inner Box (mm) 125(L) x 84(W) x 97(H)
 Outer Carton (cm) 31.0(L) x 27.0(W) x 20.0(H)



NH-AAA1100BP2

1.2V AAA



Packaging 4 260033 151940
 Blister 2 pcs/pack
 Inner Box 12 packs/box
 Outer Carton 240 packs/carton
 Gross Weight: 9.7 kg
 Volume: 0.0269 cbm

Dimensions

Blister (mm) 90(W) x 117(H) x 11(D)
 Inner Box (mm) 125(L) x 84(W) x 97(H)
 Outer Carton (cm) 51.0(L) x 27.0(W) x 19.5(H)



NH-AAA1000BP4

1.2V AAA



Packaging 4 260033 151889
 Blister 4 pcs/pack
 Inner Box 12 packs/box
 Outer Carton 144 packs/carton
 Gross Weight: 8.7 kg
 Volume: 0.0168 cbm

Dimensions

Blister (mm) 90(W) x 117(H) x 11(D)
 Inner Box (mm) 125(L) x 84(W) x 97(H)
 Outer Carton (cm) 31.0(L) x 27.0(W) x 20.0(H)



NH-AAA1000BP2

1.2V AAA



Packaging 4 260033 151872
 Blister 2 pcs/pack
 Inner Box 12 packs/box
 Outer Carton 240 packs/carton
 Gross Weight: 8.7 kg
 Volume: 0.0269 cbm

Dimensions

Blister (mm) 90(W) x 117(H) x 11(D)
 Inner Box (mm) 125(L) x 84(W) x 97(H)
 Outer Carton (cm) 51.0(L) x 27.0(W) x 19.5(H)



NH-AAA900BP4

1.2V AAA



Packaging 4 260033 151766
 Blister 4 pcs/pack
 Inner Box 12 packs/box
 Outer Carton 144 packs/carton
 Gross Weight: 8.7 kg
 Volume: 0.0168 cbm

Dimensions

Blister (mm) 90(W) x 117(H) x 11(D)
 Inner Box (mm) 125(L) x 84(W) x 97(H)
 Outer Carton (cm) 31.0(L) x 27.0(W) x 20.0(H)



NH-AAA900BP2

1.2V AAA



Packaging 4 260033 151759
 Blister 2 pcs/pack
 Inner Box 12 packs/box
 Outer Carton 240 packs/carton
 Gross Weight: 8.7 kg
 Volume: 0.0269 cbm

Dimensions

Blister (mm) 90(W) x 117(H) x 11(D)
 Inner Box (mm) 125(L) x 84(W) x 97(H)
 Outer Carton (cm) 51.0(L) x 27.0(W) x 19.5(H)



NH-AAA800BP2

1.2V AAA



Packaging 4 260033 151667
 Blister 2 pcs/pack
 Inner Box 12 packs/box
 Outer Carton 240 packs/carton
 Gross Weight: 7.7 kg
 Volume: 0.0269 cbm

Dimensions

Blister (mm) 90(W) x 117(H) x 11(D)
 Inner Box (mm) 125(L) x 84(W) x 97(H)
 Outer Carton (cm) 51.0(L) x 27.0(W) x 19.5(H)



NH-AAA600BP4

1.2V AAA



Packaging		
Blister	4 pcs/pack	Gross Weight: 7.8 kg
Inner Box	12 packs/box	Volume: 0.0168 cbm
Outer Carton	144 packs/carton	

Dimensions		
Blister (mm)	90(W) x 117(H) x 11(D)	
Inner Box (mm)	125(L) x 84(W) x 97(H)	
Outer Carton (cm)	31.0(L) x 27.0(W) x 20.0(H)	



NH-AAA600BP2

1.2V AAA



Packaging		
Blister	2 pcs/pack	Gross Weight: 7.7 kg
Inner Box	12 packs/box	Volume: 0.0269 cbm
Outer Carton	240 packs/carton	

Dimensions		
Blister (mm)	90(W) x 117(H) x 11(D)	
Inner Box (mm)	125(L) x 84(W) x 97(H)	
Outer Carton (cm)	51.0(L) x 27.0(W) x 19.5(H)	



NH-9V250BP1

9V Voltage: 8.4V



Packaging		
Blister	1 pcs/pack	Gross Weight: 12.3 kg
Inner Box	12 packs/box	Volume: 0.0385 cbm
Outer Carton	240 packs/carton	

Dimensions		
Blister (mm)	90(W) x 117(H) x 18(D)	
Inner Box (mm)	135(L) x 125(W) x 97(H)	
Outer Carton (cm)	51.0(L) x 29.0(W) x 26.0(H)	



NH-9V200BP1

9V Voltage: 8.4V



Packaging		
Blister	1 pcs/pack	Gross Weight: 11.6 kg
Inner Box	12 packs/box	Volume: 0.0385 cbm
Outer Carton	240 packs/carton	

Dimensions		
Blister (mm)	90(W) x 117(H) x 18(D)	
Inner Box (mm)	135(L) x 125(W) x 97(H)	
Outer Carton (cm)	51.0(L) x 29.0(W) x 26.0(H)	



Lithium-ion Rechargeable Batteries

- Uses up to 500 charge-discharge cycles
- Wide operating temperature range
- Holds 85% charge over 6 months



ICR18650F-26 bulk

3.7V 2600



Packaging		
Inner Box	24 packs/box	Gross Weight: 17.16 kg
Outer Carton	384 packs/carton	Volume: 0.0128 cbm

Dimensions		
Inner Box (mm)	120(L) x 80(W) x 70(H)	
Outer Carton (cm)	33(L) x 25(W) x 15.5(H)	



ICR18650F-22 bulk

3.7V 2200



Packaging		
Inner Box	24 packs/box	Gross Weight: 16 kg
Outer Carton	384 packs/carton	Volume: 0.0128 cbm

Dimensions		
Inner Box (mm)	120(L) x 80(W) x 70(H)	
Outer Carton (cm)	33(L) x 25(W) x 15.5(H)	

Battery Chargers



> Ultra Fast Chargers

Offer the ultimate in speed charging. In as little as one hour one can use the same batteries again, saving time and money.

Camelion®

BC-0907

Charges:

1-4 × AA

1-4 × AAA

Ni-MH



AC Adapter



Car Adapter



L00406A

SPECIFICATIONS

AC To DC Adapter

Input: 100-240V ~ 50/60Hz

Output : 12V =

Car Plug

Output : 12V =

Charger

Charging Currents

4x(1.4V = 2200 mA) AA Size

4x(1.4V = 800 mA) AAA Size

MAIN FEATURES

- **4 Independent Charging Channels**
- **6 Level Charge Protection**
 - -ΔV Cut-Off
 - Timer Control Protection (1.5 hours)
 - Over Temperature Protection
 - Reverse Polarity Protection
 - Over Current and Short Circuit Protection
 - Defective and Non-rechargeable Battery Detection
- **Low Current Leakage** Minimizes loss of capacity and maintains battery charge by controlling current leakage.
- **Trickle Charge** maintains battery charge.
- **World Voltage Switch Adapter**
- **Battery Refresh** reduces memory effect and enables full discharge for long battery life.
- **Car Plug Adapter**
- **Pulse Charging Technology** for fast, efficient charging.
- **Easy To Read LCD Display** shows Charging Progress, Defective Battery, Battery Refresh Features.



CHARGING TIMES

Type of Battery	Charging Times (Appr.)
Ni-MH AA 2700 mAh	80min
Ni-MH AA 2000 mAh	60min
Ni-MH AA 1500 mAh	50min
Ni-MH AAA800 mAh	70min

AVAILABLE COLORS

Silver
 Black

BARCODE



PACKAGING

UK



Blister		
Plug:	TUV	UK
Weight(g)	272	278
Dimensions (W) x (H) x (D) (mm)	112 x 188 x 67	112 x 188 x 67
Inner Carton		
Packs / Inner ctn	8	8
Net Weight(kg)	2.1	2.1
Gross Weight(kg)	2.3	2.5
Dimensions (L)x (W) x (H) (cm)	33 x 27 x 13.8	43.5 x 23 x 13.8
Outer Carton		
Packs / Carton	16	32
Net Weight(kg)	4.3	8.8
Gross Weight(kg)	5	10.45
Dimensions (L)x (W) x (H) (cm)	34.5 x 28.5 x 30	47.5 x 45 x 30
Volume(M ³)	0.0295	0.0641

> Super Fast Chargers

It charges most batteries in 1 to 4 hours. They also offer multiple levels of safety protection and many convenient features, such as LED displays and worldwide use plugs.

BC-0905A

Charges:

1 or 4 × AA

1 or 4 × AAA

Ni-MH



Flip plug

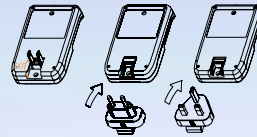

*Different plug models for different countries



SPECIFICATIONS

Input: 100-240V~50/60Hz

Output: AA: 1000mA (1- 2 pcs),
500mA (3-4 pcs)

AAA: 600mA (1- 2 pcs),
300mA (3-4 pcs)

MAIN FEATURES

- **4 Independent Charging Channels**
- **6 Level Charge Protections**
 - -ΔV Cut Off
 - Timer Control Protection
3.5 hours(1-2cells) or 7 hours(3-4cells)
 - Over Temperature Protection
 - Reverse Polarity Protection
 - Over Current and Short Circuit Protection
 - Defective and Non-rechargeable Battery Detection
- **Trickle Charge**
- **Switch and Match Plugs**
- **LED Indicators**

Red	Charging
Flashing	Defective or non-rechargeable batteries / Short circuit
Green	Fully charged / trickle

CHARGING TIMES

Type of Battery	Charging Times (Appr.)	
	1-2 Cells	3-4 Cells
Ni-MH AA 2700 mAh	3 h	6 h
Ni-MH AA 2000 mAh	2.5 h	4.5 h
Ni-MH AA 1500 mAh	2 h	3.5 h
Ni-MH AAA 800 mAh	100 min	3 h
Ni-Cd AA 1000 mAh	70 min	2 h
Ni-Cd AAA 300 mAh	40 min	70 min

AVAILABLE COLORS

 Black

BARCODE



PACKAGING



UK

Blister		
Plug:	TUV	UK
Weight(g)	153	144
Dimensions(W)x(H)x(D)(mm)	125x205x70	125x205x70
Inner Carton		
Packs / Inner ctn	16	16
Net Weight(kg)	2.45	2.3
Gross Weight(kg)	3	3
Dimensions(L)x(W)x(H)(cm)	48.5x22.5x27	48.5x22.5x27
Outer Carton		
Packs / Carton	32	32
Net Weight(kg)	4.9	4.8
Gross Weight(kg)	6.4	6.3
Dimensions(L)x(W)x(H)(cm)	51x 47 x 29	50 x 47 x 29
Volume(cbm)	0.0682	0.0682

> Fast Chargers

Charge most batteries in 4 to 8 hours. Packed with features, they are handy around the home, at the office and even when traveling.

BC-1010B

Charges:

2 or 4 × AA

2 or 4 × AAA

Ni-MH



*Different plug models for different countries



SPECIFICATIONS

Input: 100-240V ~ 50/60Hz 4W Max.

Output: 2 x (2.8V = 200mA) AA/AAA Size

MAIN FEATURES

- 2 Independent Charging Channels
- Reverse Polarity Protection
- Worldwide Voltage
- 2 LED Indicators

Red	Charging or charge completed
-----	------------------------------

CHARGING TIMES

Type of Battery	Charging Times (Appr.)
Ni-MH AA 2700 mAh	17 h
Ni-MH AA 2000 mAh	14 h
Ni-MH AA 1500 mAh	11 h
Ni-MH AAA 800 mAh	5 h
Ni-Cd AA 1000 mAh	6 h
Ni-Cd AAA 300 mAh	2 h

AVAILABLE COLORS

 Black

BARCODE

BC-1010B-4H25



4 260216 456473

PACKAGING



Blister	
Plug:	TUV
Weight(g)	118.2
Dimensions(W)x(H)x(D)(mm)	125 x 204 x 76
Inner Carton	
Packs / Inner ctn	8
Net Weight(kg)	0.95
Gross Weight(kg)	1.3
Dimensions(L)x(W)x(H)(cm)	49.5 x 23.5 x 14
Outer Carton	
Packs / Carton	32
Net Weight(kg)	3.78
Gross Weight(kg)	5.5
Dimensions(L)x(W)x(H)(cm)	50.5 x 48.5 x 30
Volume(cbm)	0.0735

BC-1002A

Charges:

2 or 4 × 

2 or 4 × 

Ni-MH



AC Cable



SPECIFICATIONS

Input: 100-240V ~ 50/60Hz

Output: 2 x (2.8V \approx 300mA) AA Size

2 x (2.8V \approx 150mA) AAA Size

MAIN FEATURES

- 2 Independent Charging Channels
- Timer Control (8 hours)
- Over Temperature Protection
- Worldwide Use
- Reverse Polarity Protection
- LED Indicators

ON	Charging
OFF	Fully charged

CHARGING TIMES

Type of Battery	Charging Times (Appr.)
Ni-MH AA 2500 mAh	8 h
Ni-MH AA 2000 mAh	8 h
Ni-MH AA 1500 mAh	6 h
Ni-MH AAA 800 mAh	8 h

AVAILABLE COLORS

 Black

BARCODE

BC-1002A4H23AR



4 260216 456497

PACKAGING



Blister	
Plug:	TUV
Weight(g)	118
Dimensions (W) x (H) x (D) (mm)	125 x 205 x 85
Inner Carton	
Packs / Inner ctn	16
Net Weight(kg)	1.89
Gross Weight(kg)	3.42
Dimensions (L)x (W) x (H) (cm)	46 x 24.5 x 27
Outer Carton	
Packs / Carton	32
Net Weight(kg)	3.8
Gross Weight(kg)	7.53
Dimensions (L)x (W) x (H) (cm)	51 x 47.5 x 29
Volume(M ³)	0.0703

BC-1012

Charges:

- 1-4 × AA
- 1-4 × AAA

Ni-MH



SPECIFICATIONS

Input: 100-240V ~ 50/60Hz

Output: 1.4V ---

AA : 400 mA (1~2 Pcs); 260 mA (3 Pcs); 200 mA (4 Pcs)

AAA : 200 mA (1~2 Pcs); 130 mA (3 Pcs); 100 mA (4 Pcs)

MAIN FEATURES

- **Charges up to 4 AA/AAA Ni-MH/Ni-Cd Batteries**
- **Multi-band LCD Monitor** for easy to read status of the charger
- **4 Independent Charging Channels** Four charging slots support any AA/AAA battery combination.
- **Reverse Polarity Protection** A special shell structure prevents incorrect battery insertion, helping avoid damage to the battery and charger.
- **Pulse Charging Technology** Uses a precisely regulated current to maximize the charging efficiency, control battery temperature and increase battery life.
- **Micro Control Unit (MCU)** The MCU enables intelligent charging by automatically identifying non-rechargeable batteries, offering multiple levels of protection including negative delta V(- Δ V), voltage protection, safety charging cut-offs.
- **Over Current Protection** Charger maintains a constant charging current during the charging cycle.
- **Short Circuit Protection** The MCU detects attempts to charge shorted batteries or directly short the output channels, in which case the LCD indicator flashes.
- **Timer Control** The charger automatically detects the correct charging time, cuts off the charger automatically(1-2 batteries 6 hours), (3 batteries 9 hours), (4 batteries 12 hours).

CHARGING TIMES

Type of Battery	Charging Times (Appr.)		
	1-2 Akkus	3 Akkus	4 Akkus
Ni-MH AA 2500 mAh	6 h	9 h	12 h
Ni-MH AA 2000 mAh	6 h	9 h	12 h
Ni-MH AAA 1000 mAh	6 h	9 h	12 h
Ni-MH AAA 800 mAh	5 h	8.5 h	11 h

AVAILABLE COLORS

white

BARCODE

BC-1012-2H23AR/2H800AR-DB



4 260216 453199

PACKAGING



Blister	
Plug:	TUV
Weight(g)	118.2
Dimensions (W) x (H) x (D) (mm)	125 x 205x 75
Inner Carton	
Packs / Inner ctn	8
Net Weight(kg)	0.95
Gross Weight(kg)	1.3
Dimensions (L)x (W) x (H) (cm)	49.5 x 23.5 x 14
Outer Carton	
Packs / Carton	32
Net Weight(kg)	3.78
Gross Weight(kg)	5.5
Dimensions (L)x (W) x (H) (cm)	50.5 x 48.5 x 30
Volume(M ³)	0.0735

> Overnight Chargers

These Standard battery chargers are ideal for travel, conventional household or office use. Some are also powered by USB ports.

BC-1001A

Charges:

1-2 x AA

1-2 x AAA

1 x 9V

Ni-MH



SPECIFICATIONS

Input: 100-240V ~ 50/60Hz

Output: 2 x (1.4V = 200 mA) AA/AAA Size

1 x (9V = 25 mA) 9V Size

MAIN FEATURES

- 3 Independent Charging Channels
- 12 Hours Timer Control
- Reverse Polarity Protection
- Slim and Portable
- Built-in Switching Adaptor for Worldwide Use
- LED Indicators

Red	Charging
Off	Fully charged

CHARGING TIMES

Type of Battery	Charging Times (Appr.)
Ni-MH AA 2700 mAh	12 h
Ni-MH AA 2000 mAh	12 h
Ni-MH AA 1500 mAh	10.5 h
Ni-MH AAA 800 mAh	5 h
Ni-MH 9V 200 mAh	9.5 h

AVAILABLE COLORS

Titanium Black

BARCODE



PACKAGING



Blister	
Plug:	TUV
Weight(g)	62
Dimensions (W) x (H) x (D) (mm)	87 x 172 x 50
Inner Carton	
Packs / Inner ctn	32
Net Weight(kg)	1.98
Gross Weight(kg)	2.42
Dimensions (L)x (W) x (H) (cm)	39.5 x 37.5 x 18
Outer Carton	
Packs / Carton	64
Net Weight(kg)	4.0
Gross Weight(kg)	7.5
Dimensions (L)x (W) x (H) (cm)	41 x 39 x 39
Volume(M ³)	0.0624

BC-0904S

Charges:

2 or 4 × AA

2 or 4 × AAA

1-2 × 9V

Ni-MH



SPECIFICATIONS

Input: 230V ~ 50Hz
 Output: 2 x (2.8V \pm 160 mA) AA size
 2 x (2.8V \pm 80 mA) AAA size
 2 x (9V \pm 25 mA) 9V size

MAIN FEATURES

- 2 independent Charging Channels
- Low Charge Current for Longer Battery Life
- Reverse Polarity Protection
- LED Indicators

Red	Charging or charge complete
-----	-----------------------------

CHARGING TIMES

Type of Battery	Charging Times (Appr.)
Ni-MH AA 2000 mAh	17 h
Ni-MH AA 1500 mAh	13 h
Ni-MH AAA 800 mAh	14 h
Ni-MH 9V 200 mAh	9.5 h

AVAILABLE COLORS

 Silver

BARCODE





PACKAGING



Blister	
Plug:	TUV
Weight(g)	274
Dimensions (W) x (H) x (D) (mm)	210 x 130 x 84
Inner Carton	
Packs / Inner ctn	4
Net Weight(kg)	1.1
Gross Weight(kg)	1.3
Dimensions (L)x (W) x (H) (cm)	49.5 x 9 x 21.5
Outer Carton	
Packs / Carton	16
Net Weight(kg)	4.4
Gross Weight(kg)	7.5
Dimensions (L)x (W) x (H) (cm)	51 x 39 x 23.5
Volume(M ³)	0.0467

BC-0901

Charges:

1-2 x 
 1-2 x 

Ni-MH



SPECIFICATIONS

Input: 100-240V ~ 50/60Hz 3W Max.
 Output: 2 x (1.4V = 150mA) AA/AAA size

MAIN FEATURES

- 2 Independent Channels
- Reverse Polarity Protection

- LED Indicators

Red	Charging or charge complete
-----	-----------------------------

CHARGING TIMES

Type of Battery	Charging Times (Appr.)
Ni-MH AA 2000 mAh	19 h
Ni-MH AA 1800 mAh	17 h
Ni-MH AAA 800 mAh	8 h

AVAILABLE COLORS

 Silver

BARCODE



PACKAGING



Blister	
Plug:	TUV
Weight(g)	155
Dimensions (W) x (H) x (D) (mm)	125 x 205 x 80
Inner Carton	
Packs / Inner ctn	16
Net Weight(kg)	2.48
Gross Weight(kg)	2.73
Dimensions (L)x (W) x (H) (cm)	39.5 x 23.5 x 12.5
Outer Carton	
Packs / Carton	32
Net Weight(kg)	4.96
Gross Weight(kg)	7.2
Dimensions (L)x (W) x (H) (cm)	48.5 x 41 x 27
Volume(M ³)	0.0537

> Universal Chargers

These can recharge many types of batteries and are perfect for high battery usage households. They are reliable and safe and can even test your batteries to see if its time for a recharge.

CM9398GS

Charges:

1- 4 AA / AAA / D / C or 1-2 9V
Ni-MH Batteries



SPECIFICATIONS

Input: 230V ~ 50Hz

Output: 4 x (1.4V \approx 250mA) D/C/AA/AAA Size
2 x (9V \approx 13mA) 9V Size

MAIN FEATURES

- 4-channel for AAA, AA, C, D ,and 2-channel for 9V batteries.
- The build-in battery change in tester.
- The timer can be selected, based on different capacity.
- Trickle charge function.
- Overcharge Protection Function.

CHARGING TIMES

Type of Battery	Charging Times (Appr.)
Ni-MH D 2500 mAh	24 h
Ni-MH C 3500 mAh	24 h
Ni-MH AA 2500 mAh	24 h
Ni-MH AAA 900 mAh	6 h
Ni-MH 9V 200 mAh	20 h

AVAILABLE COLORS

 Black

BARCODE



PACKAGING



Blister	
Weight(g)	680
Dimensions (W) x (H) x (D) (mm)	330 x 175 x 60
Inner Carton	
Packs / Inner ctn	10
Gross Weight(kg)	7.32
Dimensions (L)x (W) x (H) (cm)	59 x 23.5 x 19.5
Outer Carton	
Packs / Carton	20
Net Weight(kg)	13.7
Gross Weight(kg)	16.0
Dimensions (L)x (W) x (H) (cm)	62 x 36 x 46
Volume(M³)	0.10

CM3298

Charges:

1 - 4 C / D + 1 - 2 9V
 1 - 6 AA / AAA + 1 - 2 9V
 Ni-MH Batteries



SPECIFICATIONS

Input: AC 100 ~ 240V 50Hz/60Hz 30W
 Charging Current: 4 x C, D / DC 1.2V approx. 1,000mA
 6 x AAA / DC 1.2V approx. 500mA
 6 x AA / DC 1.2V approx. 1,000mA
 2 x DC 9V approx. 70mA
 USB 5V: approx. 500mA max.

MAIN FEATURES

- **8 Independent Charging Channels**
- **LCD Display** Shows the charging status of each individual Battery
- **6 Level Charge Protection**
 - Δ V Cut-Off
 - Timer Control Protection (10 hours)
 - Over Temperature Protection
 - Reverse Polarity Protection
 - Over Current and Short Circuit Protection
 - Defective and Non-rechargeable battery Detection
- **USB Port**
Enables you to charge external devices such as MP3 players or mobile phones
- **Trickle Charge**
- **Discharge Function**
9V battery can not be discharged
- **Battery Refresh Function**
- **World Voltage Switch Adapter**
- **LED Indicators**

Display	LED	Explanation
		The LED continuously glows green: Full charged
		The LED blinks alternately red and green: The batteries are being discharged for max. 10 minutes. (Refresh Function)
		The LED continuously glows red: Charging: The batteries are being charged
		Loading error: The LED blinks red: The inserted batteries are not positioned correctly in the charging slot or are defective.
		Check / Precharge: The LED blinks green: precharge / Check the batteries

CHARGING TIMES

Type of Battery	Charging Times (Appr.)
Ni-MH AA 2500 mAh	3.5 h
Ni-MH AAA 900 mAh	2.5 h
Ni-MH C 4000 mAh	5.5 h
Ni-MH D 4500 mAh	6.2 h
Ni-MH 9V 200 mAh	4.0 h

AVAILABLE COLORS

Silver

BARCODE



PACKAGING



Box	
Plug:	TUV
Weight(g)	660
Dimensions (W) x (H) x (D) (mm)	241.5 x 60 x 215
Outer Carton	
Packs / Carton	10
Net Weight(kg)	6.6
Gross Weight(kg)	7.3
Dimensions (L) x (W) x (H) (cm)	32 x 44.5 x 24
Volume(M ³)	0.0341

CM9388

Charges:

1- 4 AA / AAA / D / C or 1-2 9V
Ni-MH Batteries



SPECIFICATIONS

AC To DC Adapter

Input Voltage: AC 100 ~ 240V 50/60 Hz
Output Voltage: 12V DC 1A

Charger

Charging Currents
Input: DC 12V
Output:
4 x (1.4V \approx 300mA) D/C/AA/AAA Size
2 x (9V \approx 13mA) 9V Size

MAIN FEATURES

- 2 Independent Charging Channels
- To Charge AAA/AA/C/D/9V Ni-MH/Ni-Cd Rechargeable Battery
- V Detection Control
- Discharge Function
- Trickle Charge Function

CHARGING TIMES

Type of Battery	Charging Times (Appr.)
Ni-MH D 2500 mAh	12 h
Ni-MH C 2500 mAh	12 h
Ni-MH AA 2500 mAh	12 h
Ni-MH AAA 900 mAh	3.5 h
Ni-MH 9V 200 mAh	22 h

AVAILABLE COLORS

 Black

BARCODE



PACKAGING



Blister	
Weight(g)	680
Dimensions (W) x (H) x (D) (mm)	275 x 155 x 88
Outer Carton	
Packs / Carton	20
Net Weight(kg)	24
Gross Weight(kg)	25.8
Dimensions (L)x (W) x (H) (cm)	56 x 47 x 35
Volume(M ³)	0.0954

LBC-312

Charges:

Most 1.2V 3.7V or 7.4V Batteries*

- Li-ion
- Ni-MH



Includes:



AC Cable



SPECIFICATIONS

Charger

Input: 100-240V ~ 50/60Hz 12W Max

Charging current:

Lithium batteries: 3.6/3.7V 0.8A (Max)
7.2/7.4V 0.6A (Max)

Ni-MH/Ni-Cd: 2 x 1.4V = 0.7A (Max)

USB output: 5V = 0.5A

MAIN FEATURES

- **Supports Many Devices** Compatible with almost all 3.7V and 7.4V Li-ion, 1.2V Ni-MH and Ni-Cd batteries for such devices as digital cameras, Camcorders, mobile phones, MP3 /MP4 players, game players and more.
- **Automatic Voltage/Polarity Selection** Microprocessor core identifies battery type and +/- polarity, making it easy for you to use.
- **Safe** Faulty battery detection; 5 hours safety timer for Ni-MH/Cd and 10 hours safety timer for Li-ion.
- **Convenient Design**
- **Portable** Lightweight design and worldwide voltage input and adapter plugs for easy traveling.
- **USB output port** for iPhone, iPod, Android Smartphone, MP3, MP4 GPS devices and more.

LED Indicator

CONDITIONS	CHARGING (green)	POWER (red)
No power or faulty power supply	Off	Off
Power on	Off	On
Battery charging	Flashing	On
Fully charged	On	On
Faulty battery or charging process stopped by 5/10h safety timer	Flashing	Flashing

CHARGING TIMES

Battery Capacity	Charging Times
Ni-MH AA 2700 mAh	4.5 h
Ni-MH AA 2000 mAh	4.0 h
Ni-MH AA 1500 mAh	2.5 h
Ni-MH AAA 800 mAh	90 min

AVAILABLE COLORS

Black

BARCODE



PACKAGING



Blister	
Plug:	TUV
Weight(g)	179
Dimensions (W) x (H) x (D) (mm)	185 x 128 x 70
Inner Carton	
Packs / Inner ctn	10
Net Weight(kg)	1.79
Gross Weight(kg)	2.14
Dimensions (L)x (W) x (H) (cm)	56.5 x 20.6 x 13.5
Outer Carton	
Packs / Carton	40
Net Weight(kg)	7.16
Gross Weight(kg)	10.6
Dimensions (L)x (W) x (H) (cm)	58 x 42.7 x 29
Volume(M ³)	0.0719

LBC-313-1

Charges:

Most 1.2V 3.7V or 7.4V Batteries*

Li-ion

Ni-MH



Includes:



AC Cable



SPECIFICATIONS

Input: DC 5V \approx 1A

Output: 2 x (1.4V \approx 0.7A) max (1.2V NH/NC Battery)

4.2V \approx 0.7A max (3.7V Li-ion Battery)

8.4V \approx 0.45A max (7.4V Li-ion Battery)

Trickle Charging current: 70mA

MAIN FEATURES

- Charges Most 1.2V, 3.7V and 7.4V Li-ion/Ni-MH/Ni-Cd batteries
- Automatic Voltage and Polarity Selection Capability
- Automatic Detect Faulty and Defective Battery
- Timer Control Protection (5hrs for Ni-MH / Cd or 10hrs for Li-ion)
- USB Output Port Design

Charging:	Green LED flashes (1 time/s)
Fully charged:	Green LED remain on
Errors:	Red & Green LED flashes and stops charging after few seconds

CHARGING TIMES

Battery Type	Battery Capacity	Charging Times(Appr.)
NP-30 3.7V Lithium-ion	1000 mAh	2.0h
CGR-320 7.4V Lithium-ion	3200 mAh	5.5h
14500 Lithium-ion	1000 mAh	2.0h
AA Ni-MH	1500 mAh	2.5h
AAA Ni-MH	800 mAh	1.5h
AA Ni-Cd	1000 mAh	2.0h
AAA Ni-Cd	300 mAh	30min

AVAILABLE COLORS

Black

BARCODE



PACKAGING



Blister	
Plug:	LBC-313-1
Weight(g)	154
Dimensions(W)x(H)x(D)(mm)	130x188.5x62
Inner Carton	
Packs / Inner ctn	10
Net Weight(kg)	1.35
Gross Weight(kg)	1.53
Dimensions(L)x(W)x(H)(cm)	33x25.5x14.2
Outer Carton	
Packs / Carton	40
Net Weight(kg)	6.1
Gross Weight(kg)	7.6
Dimensions(L)x(W)x(H)(cm)	52.5x34.5x30.5
Volume(cbm)	0.0553

> Lithium-ion Charger

Specific charger for charging lithium battery. Integrated with multiple safety protections, providing you safety and peace of mind when charging lithium batteries.

LBC-305

Charges:

1-2 × 18650 **Li-ion**



USB Charger



SPECIFICATIONS

Input: Micro USB 5V \approx 1A

Output: 3.7V \approx 500mA

Caution: Specialized charger for 18650 Lithium-ion batteries

MAIN FEATURES

- Two independent charging channels
- Suitable for flat-top and high top 18650 Li-ion batteries
- Reverse polarity protection
- Over-charge protection
- Short circuit protection
- Power indicator

Red LED	Charging
Green LED	Fully charged

CHARGING TIMES

Battery Type	Battery Capacity	Charging Times(Appr.)
18650 Lithium-ion	2600 mAh	6.5 hours
18650 Lithium-ion	2200 mAh	5.5 hours
18650 Lithium-ion	1800 mAh	4.5 hours
18650 Lithium-ion	1500 mAh	4.0 hours

AVAILABLE COLORS

 Black

BARCODE

LBC-305-DB



4 260216 456763

PACKAGING



Blister	
Plug:	\
Weight(g)	108
Dimensions(W)x(H)x(D)(mm)	95 x 176 x 64
Inner Carton	
Packs / Inner ctn	10
Net Weight(kg)	1.075
Gross Weight(kg)	1.425
Dimensions(L)x(W)x(H)(cm)	48.5 x 19 x 10.5
Outer Carton	
Packs / Carton	40
Net Weight(kg)	4.3
Gross Weight(kg)	5.8
Dimensions(L)x(W)x(H)(cm)	50.5 x 40 x 23.5
Volume(cbm)	0.0474

CM500

Charges:

Lithium-Ion Batteries:
26650, 26500, 22650, 18650, 18490,
17670, 17500, 17355, 16340, 14500,
10440
NI-MH Batteries: AAA, AA, C, Sub-C

Li-ion

Ni-MH



MAIN FEATURES

- **4 Independent Charging Channels**
- **LCD Display** with background lighting shows independent channels, 3 charging modes, charging end, charging time, internal resistance, capacity, current selection, voltage
- **6 Level Charge Protection (IC-Control)**
 - Δ U process (Overcharge protection)
 - Overcurrent protection
 - Overheating protection
 - Battery detection
 - Short circuit protection
 - Reverse polarity protection
- **Discharge Function** Selectable 250mA/500mA
- **LCD Display with background lighting**

SPECIFICATIONS

Charger Input: DC 12V
AC Adapter Input: AC 110-230V
Output: DC 12V, 2A (24W)
Charging current: selectable
300mA / 500mA / 700mA / 1000mA
cut off at 1,48V for NI-MH + Sub-C
cut off at 4,2V for Li-Ion
Discharge current: 250mA or 500mA depending on the charging current

PACKAGING



CHARGING TIMES

- Depends on the charging current

AVAILABLE COLORS

 Black

BARCODE

CM500



4 260030 255917

Inner Carton	
Packs / Inner ctn	1
Gross Weight(kg)	573.4
Dimensions(L)x(W)x(H)(cm)	199 x 56 x 166
Outer Carton	
Packs / Carton	20
Net Weight(kg)	9.2
Gross Weight(kg)	10.6
Dimensions(L)x(W)x(H)(cm)	43 x 31 x 38,5
Volume(cbm)	0.0513

Battery Charging Table

Directions:

The following table lists out charging times for specific Camelion chargers and batteries.

For example, to find the charging time for the BC-0907 charger using a Nickel Metal Hydride AA2500mah battery, first locate the BC-0907 column. Then locate the AA2500mah row. Finally, the point of intersection indicates the value, which is 80min.

Camelion Model	BC-0907	BC-0905A		BC-1012			BC-1010B	BC-0901	BC-1002A	BC-1001A
	DC in 12V, 1.5A	2 cells	4 cells	1-2 cells	3 cells	4 cells				
Timer Control	1.5h	3.5h	7.0h	6.0h	9.0h	12h	NA	NA	8h	Voltage Cut Off
Ni-MH Batteries										
NH-D2500	NA	NA	NA	NA	NA	NA	NA	NA	NA	NA
NH-C2500	NA	NA	NA	NA	NA	NA	NA	NA	NA	NA
NH-AA2700	80min	3h	6h	T/C 6h	T/C 9h	T/C 12h	17h	23.0h	T/C 8h	T/C 12h
NH-AA2600	80min	3h	5.5h	T/C 6h	T/C 9h	T/C 12h	16h	22.0h	T/C 8h	T/C 12h
NH-AA2500	80min	3h	5.5h	T/C 6h	T/C 9h	T/C 12h	16h	22.0h	T/C 8h	T/C 12h
NH-AA2300	70min	3h	5.5h	T/C 6h	T/C 9h	T/C 12h	16h	21.0h	T/C 8h	T/C 12h
NH-AA2200	70min	2.5h	5h	T/C 6h	T/C 9h	T/C 12h	15h	20.0h	T/C 8h	T/C 12h
NH-AA2000	60min	2.5h	4.5h	T/C 6h	T/C 9h	T/C 12h	14h	19.0h	T/C 8h	T/C 12h
NH-AA1800	60min	2h	4.5h	6h	T/C 9h	T/C 12h	13h	17.0h	T/C 8h	T/C 12h
NH-AA1500	50min	2h	3.5h	4.5h	7h	10.5h	11h	14.0h	6h	10.5h
NH-AAA1100	90min	2h	4h	T/C 6h	T/C 9h	T/C 12h	6h	9.0h	T/C 8h	6h
NH-AAA1000	80min	2h	3.5h	T/C 6h	T/C 9h	T/C 12h	5.5h	9.0h	T/C 8h	5.5h
NH-AAA900	80min	100min	3.5h	5h	T/C 9h	12h	5h	8.0h	T/C 8h	5h
NH-AAA800	70min	100min	3h	5h	8.5h	11h	5h	8.0h	T/C 8h	5h
NH-AAA600	60min	70min	2.5h	3.5h	5.5h	7h	3.5h	5.0h	5h	3.5h
NH-9V250	NA	NA	NA	NA	NA	NA	22h	NA	NA	11h
NH-9V200	NA	NA	NA	NA	NA	NA	18h	NA	NA	9.5h

Camelion Model	BC-0904S	CM-9398GS	CM3298	CM9388	LBC-312	LBC-313-1
Timer Control	NA	3 / 6 / 9 / 24h	10h	NA	5h	NA
Ni-MH Batteries						
NH-D2500	NA	14h	3h	12h	NA	NA
NH-C2500	NA	14h	3h	12h	NA	NA
NH-AA2700	22h	14h	3h	12h	4.5h	4.5h
NH-AA2600	20h	13h	3h	12h	4h	4h
NH-AA2500	20h	13h	3h	12h	4h	4h
NH-AA2300	19h	12h	2.5h	10h	4h	4h
NH-AA2200	19h	12h	2.5h	10h	3.5h	3.5h
NH-AA2000	17h	10.5h	2.5h	9.5h	3.5h	3.5h
NH-AA1800	16h	10h	2h	8.5h	3h	3h
NH-AA1500	13h	8.5h	2h	7h	2.5h	2.5h
NH-AAA1100	17h	4.5h	2.5h	4h	100min	100min
NH-AAA1000	16h	4.5h	2h	3.5h	100min	100min
NH-AAA900	15h	3.5h	2h	3.5h	90min	90min
NH-AAA800	14h	3.5h	2h	3h	90min	90min
NH-AAA600	10.5h	3h	1.5h	2.5h	1h	1h
NH-9V250	11h	11h	4.5h	27h	NA	NA
NH-9V200	9.5h	9.5h	3.5h	22h	NA	NA

Notes:

NA - Not Applicable.

T/C: Charger has timer control. This is the cut off time, whether the battery is fully charged or not..

All the data is based on Camelion latest lab tests. Charging times may vary based upon temperature, product age, voltage and other conditions. This data sheet is for customer reference purposes only and to help customers choose the appropriate product. Contents do not constitute a warranty.

For information on specific Camelion products please visit our website at www.camelionbattery.com or contact us directly at info@camelionbattery.com.

Power Supplies



> Power Banks

Camelion Power Banks offers you fast, easy and reliable power source for your mobile devices. Integrated with top quality battery cells, we ensure you a product of long life and fully compliant with international safety standards

Camelion®

PS675



PS675-DB



Accessory:
USB Cable
(L:30cm)



LED Status (● ON ○ OFF)	Capacity
● ● ● ●	76%-100%
○ ● ● ●	51%-75%
○ ○ ● ●	26%-50%
○ ○ ○ ●	<25%

Main Features

- LED flashlight function
- 2.1A output
- Compatible with most mobile devices
- Short circuit, over discharge, overcharge and over current protections
- Specially designed cover – unique and elegant

Specifications

Battery Capacity: 6000mAh Li-polymer battery 22.2Wh

Power Input: Micro USB 5V \pm 2A

Power Output: 5V \pm 2.1A

Packaging

Blister	Weight(g)	180
	Dimensions (W) x (H) x (D)(mm)	135 x 230 x 36
Inner Carton	Packs / Inner ctn	12
	Net Weight(kg)	/
	Gross Weight(kg)	/
	Dimensions (L)x (W) x (H) (cm)	/
Outer Carton	Packs / Carton	48
	Net Weight(kg)	/
	Gross Weight(kg)	/
	Dimensions (L)x (W) x (H) (cm)	55 x 44.5 x 25.5
	Volume(cbm)	0.0625

PS679



PS679-160CB



Accessory:
USB Cable
(L:30cm)



LED Status (● ON ○ OFF)	Capacity
● ● ● ●	76%-100%
○ ● ● ●	51%-75%
○ ○ ● ●	26%-50%
○ ○ ○ ●	<25%

Main Features

- Compatible with most mobile devices
- Auto On/Off capability
- Multiple safety protections (Short Circuit, Over Discharge, Over Charge, Over Current)
- LED indicator

Specifications

Battery Capacity: 16000mAh Lithium-ion battery 59.2Wh

Power Input: Micro USB 5V \pm 2A

Power Output: 5V \pm 2.1A

Packaging

Box	Weight(g)	440
	Dimensions (W) x (H) x (D)(mm)	105 x 189 x 30
Inner Carton	Packs / Inner ctn	6
	Net Weight(kg)	/
	Gross Weight(kg)	/
	Dimensions (L)x (W) x (H) (cm)	21.4x19x13.2
Outer Carton	Packs / Carton	24
	Net Weight(kg)	10.5
	Gross Weight(kg)	11.4
	Dimensions (L)x (W) x (H) (cm)	40.2 x 23.2 x 28.9
	Volume(cbm)	0.027

USB Power Adapters

Camelion USB Power Adapters offers you fast, reliable and efficient charging at home, office or during your travels. It comes in different sizes and all works with universal voltage, providing you the convenience of charging your mobile devices wherever you go.

AD568

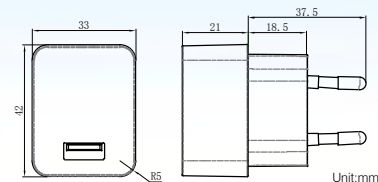

AD568-DB



Main Features

- 1A direct power source for mobile devices
- Use any cable with charger
- Over current, overheating and short circuit protections
- Universal voltage

Specifications

Input: 100-240V~50/60Hz 150mA Max

Output: 5V = 1A

Packaging

Blister	Plug:	TUV	UL
	Weight(g)	77	68
Dimensions (W) x (H) x (D)(mm)		107x171x64	107 x 171 x 64
Inner Carton	Packs / Inner ctn	12	12
	Net Weight(kg)	0.78	0.67
	Gross Weight(kg)	0.95	0.84
Dimensions (L)x (W) x (H) (cm)		42.4 x 20.1 x 11.4	42.4 x 20.1 x 11.4
Outer Carton	Packs / Carton	48	48
	Net Weight(kg)	3.13	2.69
	Gross Weight(kg)	4.53	3.98
	Dimensions (L)x (W) x (H) (cm)	43.5 x 41.8 x 24.8	43.5 x 41.8 x 24.8
Volume(cbm)		0.0451	0.0635

AD569

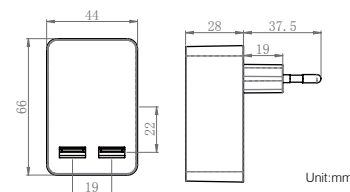

AD569-DB



Main Features

- 3.4A output USB port for fastest possible charging
- Dual USB output
- Direct power source for tablets and mobile devices
- Use any cable with charger
- Over current, overheating and short circuit protections
- Universal voltage

Specifications

Input: 100-240V~50/60Hz 430mA Max

Output: 5V = 3.4A (2.4A+1A)

Packaging

Blister	Plug:	TUV	UL
	Weight(g)	123	114
Dimensions (W) x (H) x (D)(mm)		107 x 171 x 73	107 x 171 x 73
Inner Carton	Packs / Inner ctn	12	12
	Net Weight(kg)	1.48	1.38
	Gross Weight(kg)	1.65	1.55
Dimensions (L)x (W) x (H) (cm)		47.5 x 21 x 11.4	47.5 x 21 x 11.4
Outer Carton	Packs / Carton	48	48
	Net Weight(kg)	5.9	5.5
	Gross Weight(kg)	7.8	7.4
	Dimensions (L)x (W) x (H) (cm)	49 x 43.5 x 24.8	49 x 43.5 x 24.8
Volume(cbm)		0.0529	0.0697

DD801



DD801-DB

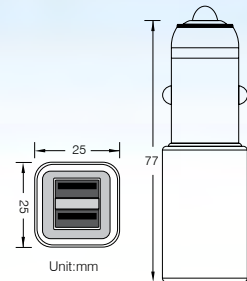

Main Features

- **Car Charger with Dual USB Port** Up to 5V, 2100mA direct power sources for iPad, iPod units, iPhone, mobile phones, PSP, Blackberry, Digital cameras and other music players and devices. Just plug it in to your car cigarette or plug into electric socket, power up and start to play.
- **Short Circuit Protection** Damage to the charger and mobile device is prevented in case of a short circuit.

Specifications

Input: 12 - 24V $\overline{\text{---}}$

Output: 5V $\overline{\text{---}}$ 2.1A using 1USB port
5V $\overline{\text{---}}$ 1A using 2USB ports

Packaging

Blister	Weight(g)	66
	Dimensions (W) x (H) x (D)(mm)	133 x 220 x 69
Inner Carton	Packs / Inner ctn	18
	Dimensions (L)x (W) x (H) (cm)	41.5 x 30 x 23.5
Outer Carton	Packs / Carton	36
	Net Weight(kg)	2.4
	Gross Weight(kg)	3.9
	Dimensions (L)x (W) x (H) (cm)	48.5 x 31.5 x 43.5
	Volume(cbm)	0.0665

DD802



DD802-DB

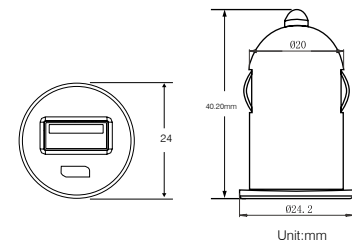

Main Features

- **USB Port For In-Car Power** Just plug it in and play.
- **5V 1A Power Output** Supports a wide range of mobile devices, such as iPhone®, PSP®, and other portable devices.
- **Short Circuit Protection** Reduces the risk of damage to your unit and the adapter in case of a short circuit.

Specifications

Input: 12 - 24V

Power Output: 5V $\overline{\text{---}}$ 1A

Packaging

Blister	Weight(g)	56.3
	Dimensions (W) x (H) x (D)(mm)	112 x 184 x 57
Inner Carton	Packs / Inner ctn	24
	Dimensions (L)x (W) x (H) (cm)	23.1 x 19.1 x 12.4
Outer Carton	Packs / Carton	48
	Net Weight(kg)	2.7
	Gross Weight(kg)	3.9
	Dimensions (L)x (W) x (H) (cm)	39.6 x 24.5 x 40
	Volume(cbm)	0.0388

DD823

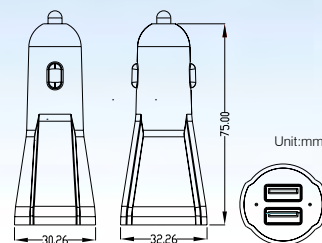

DD823-DB



Main Features

- Compatible with most mobile devices
- Dual-USB port design
- Max 2.4 fast charging
- Short circuit protections

Specifications

Input: 12V - 24V \equiv

Output: 5V \equiv 2.4A+2.4A

Packaging

Blister	Weight(g)	65
	Dimensions (W) x (H) x (D)(mm)	133 x 220 x 35
Inner Carton	Packs / Inner ctn	18
	Dimensions (L)x (W) x (H) (cm)	41.5 x 23.5 x 23.5
Outer Carton	Packs / Carton	36
	Net Weight(kg)	2.4
	Gross Weight(kg)	3.9
	Dimensions (L)x (W) x (H) (cm)	48.5 x 42.5 x 25
	Volume(cbm)	0.0516

AD568+DD811+CDC015

3in1 USB Charging Kit



AD568+DD811+CDC015-CB



Main Features

- | | | |
|--|--|---|
| USB Power Adapter <ul style="list-style-type: none"> • 1A Direct power source for the mobile devices • Compliant to any USB cable • Over current, overvoltage and short circuit protection • Universal voltage 100 - 240V | USB Car Charger <ul style="list-style-type: none"> • Compatible with most mobile devices • Short circuit protection | 2in1 USB Charging Cable <ul style="list-style-type: none"> • Micro USB + 8pin Lightning • Durable Nylon Cable • Withstand bending • Plug in/out (up to 3000 times) • Compatible with 2.4A fast chargers |
|--|--|---|

Specifications

USB Power Adapter
Input:100-240V~50/60Hz 150A
Output: 5V \equiv 1.0A

USB Car Charger
Input:12 - 24V \equiv 1.3A (max)
Output: 5V \equiv 2.1A

Packaging

Box	Plug:	UL/UK/TUV/SA
	Weight(g)	105
	Dimensions (W) x (H) x (D)(mm)	91 x 122 x 37
Inner Carton	Packs / Inner ctn	10
	Net Weight(kg)	/
	Gross Weight(kg)	/
	Dimensions (L)x (W) x (H) (cm)	20 x 19.5 x 12.8
Outer Carton	Packs / Carton	40
	Net Weight(kg)	5.3
	Gross Weight(kg)	5.6
	Dimensions (L)x (W) x (H) (cm)	42.5 x 22 x 28.5
	Volume(cbm)	0.0752

Device Chart

BEST YES NO

		Power Bank		USB Power Adapters				USB Car Charger
USB Enable Devices		PS675	PS679	AD568	AD569	DD801	DD802	DD823
Mobile & Professional	iPhone 4/4S/5	✓	✓	✓	✓	✓	✓	✓
	iPod®	✓	✓	✓	✓	✓	✓	✓
	iPad®	✓	✓	✓	✓	✓	✓	✓
	Sumsung	✓	✓	✓	✓	✓	✓	✓
	Sony	✓	✓	✓	✓	✓	✓	✓
	HTC	✓	✓	✓	✓	✓	✓	✓
	Blackberry®	✓	✓	✓	✓	✓	✓	✓
	Nokia	✓	✓	✓	✓	✓	✓	✓
	LG	✓	✓	✓	✓	✓	✓	✓
	Sharp	✓	✓	✓	✓	✓	✓	✓
	Motorola	✓	✓	✓	✓	✓	✓	✓
	Smart Phone	✓	✓	✓	✓	✓	✓	✓
	Portable Gaming Devices	✓	✓	✓	✓	✓	✓	✓
	Tablet	✓	✓	✓	✓	✓	✓	✓
Others	MP3/MP4/MP5	✓	✓	✓	✓	✓	✓	✓
	Loudspeaker	✓	✓	✓	✓	✓	✓	✓
	AM/FMRadio	✓	✓	✓	✓	✓	✓	✓
	Digital Camera	✓	✓	✓	✓	✓	✓	✓
	GPS	✓	✓	✓	✓	✓	✓	✓
	USB battery charger	✓	✓	✓	✓	✓	✓	✓
	Electronic shaver	✓	✓	✓	✓	✓	✓	✓

Remark: 1. The capacity of the iPad battery must be not less than 5%.
 2. Apply for USB 2.0 or lower version only.
 3. Camelion accepts no responsibility for any accidents resulting from use of this information.

Flashlights & Lanterns



SuperBright™ Flashlights

LED Flashlights for Home or Outdoor Use



Multi-head LED Classic Flashlights

- **Cloverleaf Reflector System** for maximum focus and intensity
- **Energy Saving LEDs** up to 5 times brighter, 8 times more efficient than regular krypton bulbs*
- **Long Service Life** Up to 180 hours continuous lighting*
- **Never Replace LEDs** 100,000h LED lifetime
- **Handy Grip** with hooks, anti-roll design

*Camelion 2009 Lab Tests. Performance subject to battery, temperature and ambient lighting conditions.

Best for:

- Indoor and/or outdoor use
- Handy for camping, travel, fishing
- Household use, walking the dog



Hook Ring



6 LED



FL6L2D2R20P



4 260216 452796

Product Picture	Name	Model #	Specifications						
			LEDs	LED Type	Lumens	Battery Mode	Body Material	Available Colors	Water Resistant
	Multi-Head LED Classic Flashlights	FL6L2D	6	Superbright LED	12lm	2 x D	Plastic	Yellow	✓

Pack. Picture	Name	Item#	Packaging Type	Included Batteries	Packaging Details										
					Blister/Box Details				Outer Carton Details						
					Dimensions (mm)			Net Weight (g)	Packs/ Carton	Dimensions (cm)			Volume (M ³)	Gross Weight (Kg)	Net Weight (kg)
L Length	W Width	D Depth			L Length	W Width	D Depth								
	Multi-Head LED Classic Flashlights	FL6L2D2R20P	Blister Pack	2 x R20P	264	144	40	285	24	55.5	42.5	18.5	0.0436	8.3	7.4

LED Flashlights for Everyday Use









Classic Flashlights

- Super bright and replaceable LED bulb
- 35 lumens of light
- Long battery service life
- Many Color Options

Best for:

- Indoor & outdoor usage
- Household use

			Specifications					
Product Picture	Name	Model #	Bulb Type	Lumens	Battery Mode	Body Material	Available Colors	Water Resistant
	Classic Flashlights	FL1L2D	LED	35lm	2 x D	Plastic	 Red Yellow Blue Black	✗
	Classic Flashlights	FL1L2C	LED	35lm	2 x C	Plastic	 Red Yellow Blue Black	✗
	Classic Flashlights	FL1L2AA	LED	35lm	2 x AA	Plastic	 Red Yellow Blue Black	✗

FL1L2D

 **1 LED**



FL1L2D2R20P



FL1L2DD12



FL1L2C

 **1 LED**



FL1L2C2R14P



FL1L2AA

 **1 LED**





FL1L2AA2R6P



FL1L2AAD24



Packaging Details

Pack. Picture	Name	Item#	Packaging Type	Included Batteries	Blister/Box Details				Outer Carton Details						
					Dimensions (mm)			Net Weight (g)	Packs/ Carton	Dimensions (cm)			Volume (M ³)	Gross Weight (Kg)	Net Weight (kg)
					L Length	W Width	D Depth			L Length	W Width	D Depth			
	Classic Flashlights	FL1L2DB2R20P	Blister Pack	2 x R20P	292	158	64	312	24	46	31.5	31	0.0449	9.0	7.5
		FL1L2DD12	Display box	—	250	188	195	1332	4	51.5	40	21.5	0.0443	7.0	5.3
	Classic Flashlights	FL1L2CB2R14P	Blister Pack	2 x R14P	240	131	50	170	24	47	26	20	0.0244	4.1	5.0
	Classic Flashlights	FL1L2AAB2R6P	Blister Pack	2 x R6P	211	99	38	84	60	40	30	23	0.0276	6.0	5.3
		FL1L2AAD24	Display box	—	230	154	150	1116	8	48	33	32.5	0.0515	10.5	8.9

SuperBright™ Searchlamps

LED Search lamps for Home or Outdoor Use



Multi-head LED Searchlamps

- **Powerful** Lights distances up to 150 meters*
- **Cloverleaf Reflector System** for maximum focus and intensity
- **Energy Saving LEDs** up to 5 times brighter, 8 times more efficient than regular krypton bulbs*
- **Long Service Life** Up to 500 hours continuous lighting*
- **Never Replace LEDs** 100,000h LED lifetime
- **Handy Grip** with hooks, anti-roll design

**Camelion 2009 Lab Tests. Performance subject to battery (alkaline), temperature and ambient lighting conditions.*

Best for:

- Indoor and/or outdoor use
- Military, security, campus, factory, emergency kits
- Vehicle use, garages, auto service use
- Handy for camping, travel, fishing

Product Picture	Name	Model #	Specifications						
			LEDs	LED Type	Lumens	Battery Mode	Body Material	Available Colors	Water Resistant
	Multi-Head LED Search lamps	FL-16LED	16	Super Bright LED	32lm	4 x D/ 1 x 4R25	Plastic	Yellow	✓
	Multi-Head LED Search lamps	FL-9LED	9	Super Bright LED	18lm	4 x AA	Plastic	Yellow	✓
	LED Search lamps	CM25L	1	Super Bright LED	45lm	1 x 4R25	Plastic	Yellow	/

FL-16LED

 **16LED**

Up to
500 Hrs
Continuous Use



CE

FL-16LED-4R20PCB

 4 260033 1155504

FL-9LED

 **9LED**

Up to
150 Hrs
Continuous Use



CE

FL-9LED-4R6P

 4 260033 1155481

CM25L

 **1LED**

Up to
100 Hrs
Continuous Use





CE

CM25L-4R25

 4 260216 4456770

Packaging Details

Pack. Picture	Name	Item#	Packaging Type	Included Batteries	Blister/Box Details			Net Weight (g)	Packs/ Carton	Outer Carton Details					
					Dimensions (mm)					Dimensions (cm)			Volume (M ³)	Gross Weight (Kg)	Net Weight (kg)
					L Length	W Width	D Depth			L Length	W Width	D Depth			
	Multi-Head LED Search lamps	FL-16LED-4R20PCB	Box	—	250	123	135	708	12	52	39	30	0.0608	10.6	9.6
	Multi-Head LED Search lamps	FL-9LED-4R6P	Shrink pack	4 x R6P	100	146	110	278	36	59	54	24	0.0765	12.0	10
	LED Search lamps	CM25L-4R25	Shrink pack	1 x 4R25	255	110	115	800	12	53	32.5	28.5	0.0491	12.5	9.6

LED Key Chain



Super Bright

- Rubberized durable case
- Long Continuous Lighting up to 14hrs*
- Super Bright in-built LED

Best for:

Traveling, hiking, camping, fishing and athletics

Specifications							
Model#	LEDs	LED Type	Luminous Flux	Battery Mode	Body Material	Available Colors	Water Resistant (Y/N)
SL3013	1	white color LED	5lm	3 x LR44	Plastic	<div style="display: flex; flex-direction: column; gap: 5px;"> <div> Yellow</div> <div> Red</div> <div> Green</div> <div> Blue</div> </div>	N

SL3013



LED

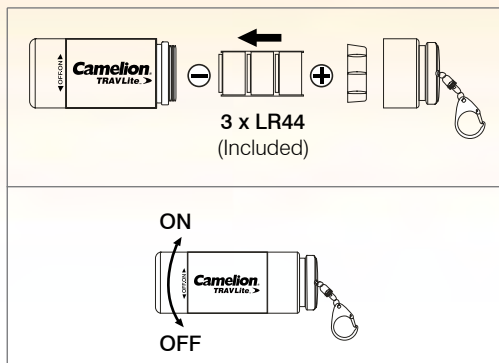

SL3013-3LR44BP



SL3013-3LR44-PB36



Packaging Details

Item#	Packaging Type	Included Batteries	Blister/Box Details					Outer Carton Details					
			Dimensions (mm)			Net Weight (g)	Packs/ Carton	Dimensions (cm)			Volume (M ³)	Gross Weight (Kg)	Net Weight (kg)
			L Length	W Width	D Depth			L Length	W Width	H Height			
SL3013-3LR44BP	Blister Pack	3xLR44	167	155	103	26	192	32.5	31.5	45.5	0.0466	7.7	5.0
SL3013-3LR44-PB36	Display Box	3xLR44	395	165	225	850	12	41.5	24.5	34.5	0.0347	11.0	10.2

LED Flashlights

ideal Lighting for Out of Doors



LED Pocket Flashlight

- Ultra shock resistant up to 3 meters drop height
- Continuous lighting up to 20 hrs*
- LED light source
- Water resistant (IPX4)**
- Slim portable design

Best for:

Traveling, hiking, camping, fishing and athletics

*Camelion 2015 lab tests, LED brightness will attenuate when battery power is weak.

**An IPX4 designation means it will withstand against rain and jets of water, but it not suitable nor guaranteed to survive for swimming or immerse under water.

*** An IPX7 designation means it can withstand accidental immersion in water within the depth of one meter for up to 30 minutes.



LED Rubber Flashlight

- **Heavy Duty Rubberized Case**
- **Shockproof** up to 2 meters drop
- **Water Resistant** (up to IPX7****)
- **Shatterproof Optical Lens**
- **Non Slip Grip** oil/grease resistant grip with push button switch and end strap
- **Never replace LEDs** 100,000 hr lifetime
- **Brightness Intensifying Optical Cavity Design**

Model#	Specifications						
	LEDs	LED Type	Luminous Flux	Battery Mode	Body Material	Available Colors	Water Resistant (Y/N)
HP7011	1	0.5W LED	45 lm	3 x AAA	Rubber	<div style="display: flex; gap: 5px;"> ■ Red ■ Green </div>	Y
PT1L2D	1	Superbright LED	45 lm	2 x D	Rubber	<div style="display: flex; gap: 5px;"> ■ Red ■ Blue </div>	Y
PT1L2AA	1	Superbright LED	45 lm	2 x AA	Rubber	<div style="display: flex; gap: 5px;"> ■ Red ■ Blue </div>	Y

HP7011

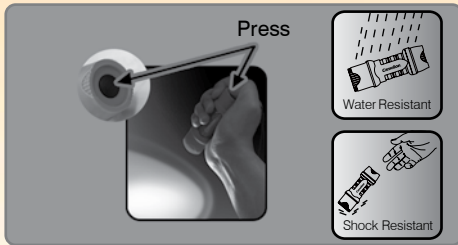

Up to
20 Hrs
Continuous
use



CE

HP7011-3R03BP



4 260216 450136



PT1L2D

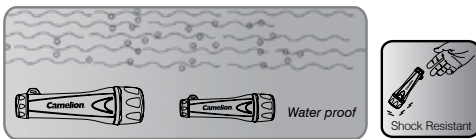

Up to
140 Hrs
Continuous
use



CE

PT1L2D-2R20PBP



4 260216 456381



PT1L2AA

Up to
20 Hrs
Continuous
use



CE

PT1L2AA-2R6PBP



4 260216 456374



Packaging Details

Item#	Packaging Type	Included Batteries	Blister/Box Details					Outer Carton Details					
			Dimensions (mm)			Net Weight (g)	Packs/ Carton	Dimensions (cm)			Volume (M ³)	Gross Weight (Kg)	Net Weight (kg)
			L Length	W Width	D Depth			L Length	W Width	H Height			
HP7011-3R03BP	Blister Pack	3R03P	190	110	40	96.5	48	51.5	21.5	26.5	0.0294	6.4	4.7
PT1L2D-2R20PBP	Blister Pack	2 x 2R20P	305	175	70	446	24	50.5	45	33	0.0750	11.7	10.7
PT1L2AA-2R6PBP	Blister Pack	2 x R6P	248	120	50	161	48	49.5	36	33	0.0588	8.7	7.7

Penlight Flashlights

An Elegant Gift and a Handy Tool



- Powerful Spot Beam
- Durable Aircraft Aluminum
- Strong Pocket Clip
- Push Button Switch



Best for:

- Useful tool for doctors
- Elegant, fashionable gift
- Great for hard to reach recesses and gaps



Specifications

Product Picture	Name	Model #	Type of Bulb	Voltage/Ampere	Battery Mode	Body Material	Available Colors	Water Resistant
	Penlight Flashlight	DL2AAAS	Vakuum	2.2V/250mA	2AAA	Aircraft aluminum	<input type="checkbox"/> Silver	X

Packaging Details

Pack. Picture	Name	Item#	Packaging Type	Included Batteries	Blister/Box Details				Outer Carton Details						
					Dimensions (mm)			Net Weight (g)	Packs/ Carton	Dimensions (cm)			Volume (M ³)	Gross Weight (Kg)	Net Weight (kg)
					L Length	W Width	D Depth			L Length	W Width	D Depth			
	Penlight Flashlight	DL2AAAS	Blister Pack	2 x R03P	200	155	115	56	100	48.5	39.0	25.0	0.0479	5.6	7.0

LED Inspection Light

3W COB LED

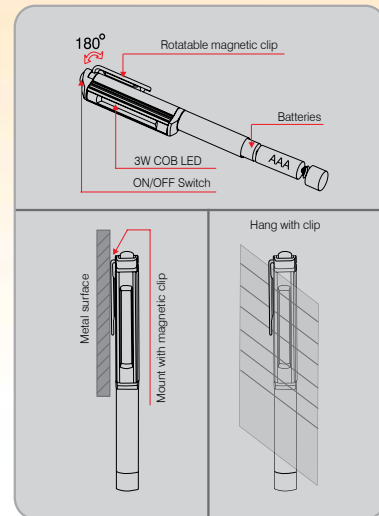

- Powerful 3W COB lighting
- Durable CNC-machined aluminum alloy body
- Rotatable magnetic clip
- None replace needed LED of up to 50,000 hours lifespan



T11-3R03PD12



4 260216 456244

Specifications

Model#	LEDs	LED Type	Luminous Flux	Battery Mode	Body Material	Available Colors	Water Resistant (Y/N)
T11	1	3W COB LED	200lm	3 x AAA	Plastic	<ul style="list-style-type: none"> ■ Blue ■ Red ■ Silver 	N

Packaging Details

Item#	Packaging Type	Included Batteries	Blister/Box Details					Outer Carton Details					
			Dimensions (mm)			Net Weight (g)	Packs/ Carton	Dimensions (cm)			Volume (M ³)	Gross Weight (Kg)	Net Weight (kg)
			L Length	W Width	D Depth			L Length	W Width	H Height			
T11-3R03PD12	Display Box	3 x R03P	202	125	40	94	48	58	36.5	22.5	0.0477	5.5	4.5

CT-Series LED Flashlights





High grade aluminium flashlight with maximum illumination

- High Performance Chip Module SMD Technology
- Unbreakable Anodized Aluminium Alloy
- Ultra-High Luminosity

Best for:

- Security, police, military, emergency response
- Ideal for work, outdoor and general purpose activities

Product Picture	Name	Model #	Specifications						
			LEDs	LED Type	Lumens	Battery Mode	Body Material	Available Colors	Water Resistant
	9 LED Flashlight	CT4004	9	LED Technology	120lm	3 x AAA	Aluminium	<input checked="" type="checkbox"/> Black <input type="checkbox"/> Silver	✗
	30 LED Flashlight	CT4005	30	LED Technology	120lm	2 x D	Aluminium	<input checked="" type="checkbox"/> Black	✗
	3 Watt Flashlight	CT4010	1	High-power-chip SMD Technology	130lm	3 x AAA	Aluminium	<input type="checkbox"/> Silver	✗

CT4004

 **9 LED**



CE



CT4005

 **30 LED**



CE



CT4010



 **3 Watt LED**



CE



Packaging Details

Pack. Picture	Name	Item#	Packaging Type	Included Batteries	Blister/Box Details				Outer Carton Details						
					Dimensions (mm)			Net Weight (g)	Packs/ Carton	Dimensions (cm)			Volume (M ³)	Gross Weight (Kg)	Net Weight (kg)
					L Length	W Width	D Depth			L Length	W Width	D Depth			
	9 LED Flashlight	CT4004	Double blister	3 x R03P	244	123	40	149.9	120	51	38	56	0.1085	20	19
	30 LED Flashlight	CT4005	Double blister	_____	345	180	60	397.3	40	74	45	30.5	0.1016	17	16
	3 Watt Flashlight	CT4010	Double blister	3 x LR03	242	121	35	153.8	120	51	38	56	0.1085	20	19

CT-Series LED Flashlights

Best Lighting for Outdoors



LED Lantern

Key Features	Solar Lantern	1 Watt Table Lantern
Lighting Mode	100 % / 50 %	100 % / 50 % /Flashing
Long Life Use	3 h	17 h
Key Applications	Outdoors, Camping, Travel	

- **Effective Lighting**
- **LED Technology provides outstanding Illumination and high efficiency**
- **Handy Easy grip, adjustable handle with hook**
- **Rubber boot push switch**

3 Watt Headlight

- **High Performance Chip Module SMD Technology**
- **Low Power Consumption**
- **Ultra-High Luminosity**
- **3 different LED mode**

Best for:

Camping, Outdoors, Caving

Product Picture	Name	Model #	Specifications						
			LEDs	LED Type	Lumens	Battery Mode	Body Material	Available Colors	Water Resistant
	36 LED Solar Lantern	Solar Lantern	36	LED Technology	up to 100lm	4 x D / inbuild rechargeable battery	Rubberized Aluminium	■ Black	✗
	1 Watt LED Table Lantern	CT4008	1	High-power-chip SMD Technology	70lm	4 x AA	Rubberized Aluminium	■ Black	✗
	3 Watt LED Headlight	CT4007	1	High-power-chip SMD Technology	130lm	3 x AAA	Plastic	■ Black	✗

Solar Lantern

36 LED



Solar Lantern



CT4008

1 Watt Table Lantern



CT4008



CT4007

3 Watt Headlight



CT4007



Packaging Details

Pack. Picture	Name	Item#	Packaging Type	Included Batteries	Blister/Box Details			Outer Carton Details							
					Dimensions (mm)			Packs/ Carton	Dimensions (cm)			Volume (M ³)	Gross Weight (Kg)	Net Weight (kg)	
					L Length	W Width	D Depth		L Length	W Width	D Depth				
	36 LED Solar Lantern	Solar Lantern	Hardbox	_____	265	140	140	681.7	24	57.5	43.5	37.5	0.0938	23	20
	1 Watt LED Table Lantern	CT4008	Double blister	_____	242	123	50	164.7	100	57	54.5	36	0.1119	21.5	18.5
	3 Watt LED Headlight	CT4007	Double blister	3 x LR03	245	125	100	150.5	100	52	38	58.5	0.1156	15.5	13.5

Work Light + Multi Light 2 in 1

Ideal Lighting for Workplace





Work Light + Multi Light 2 in 1

- Outstanding illumination provided by 3W COB LED
- Strong magnet button and 360 degrees swivel hook
- Durable rubberized ABS casing for better comfort

Best for:

Professionals, home and office use.

Model#	LED Type	Luminous Flux	Battery Mode	Body Material	Available Colors	Water Resistant (Y/N)
SL5240N	3W COB LED	220lm	3 x AA	Plastic	 Black+Red	N
SL7280N	3W COB LED	200lm	3 x AAA	Plastic	 Black+Red	N

Work Light



SL5240N 3W COB LED



SL5240N-3R6PD12



Multi Light 2 in 1



SL7280N 3W COB LED



SL7280N-3R03PD12



Packaging Details

Item#	Packaging Type	Included Batteries	Blister/Box Details				Outer Carton Details						
			Dimensions (mm)			Net Weight (g)	Packs/ Carton	Dimensions (cm)			Volume (M ³)	Gross Weight (Kg)	Net Weight (kg)
			L Length	W Width	D Depth			L Length	W Width	H Height			
SL5240N-3R6PD12	Display Box	3xR6P	202	227	210	1750	4	49	24	46	0.0541	9.0	7.0
SL7280N-3R03PD12	Display Box	3xR03P	143	232	108	1250	8	62.5	34	22.5	0.0479	11.5	10.5

3W COB LED



Main Features

- Powerful 3W COB LED illumination
- 360° rotatable stand for different lighting directions
- Strong magnet button to attach on metallic surface
- Non replace needed LED

Specification

Power source: 4 x AAA battery
 Light source: 3W COB LED
 Luminous flux: 200LM*
 Constant operating time: 3 hrs
 Lighting modes: On/Off
 Dimensions: 91 x 35 x 128mm

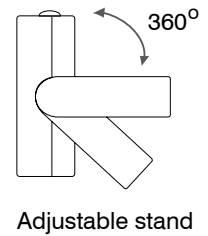
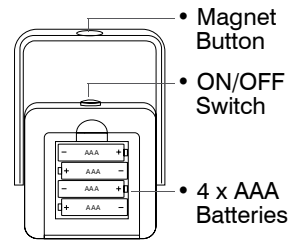

Specifications							
Model#	LEDs	LED Type	Luminous Flux	Battery Mode	Body Material	Available Colors	Water Resistant (Y/N)
S31	1	3W COB LED	200lm	4 x AAA	Plastic	Black	N

Packaging Details													
Item#	Packaging Type	Included Batteries	Blister/Box Details					Outer Carton Details					
			Dimensions (mm)			Net Weight (g)	Packs/ Carton	Dimensions (cm)			Volume (M ³)	Gross Weight (Kg)	Net Weight (kg)
			L Length	W Width	D Depth			L Length	W Width	H Height			
S31-4LR03D12	Display Box	4 x LR03	320	170	132	2046	48	36	34	29	0.0355	8.18	8.58

2-IN-1 Spotlight



Main Features

- 3W high power LED and duo color COB
- 2-IN-1 multi-function lighting
- Five different lighting modes (Low Beam/ High Beam/ White Light/ Red Light/ Red Flashing)
- Two-position side handle with a folding tail handle

Specification

Power Source: 3 x AA Size Battery
 Light Source: 3W White LED + 3W Duo color COB
 LED Light Modes: Low Beam/ High Beam
 COB Light Modes: White Light/ Red Light/ Red Flashing
 LED Luminous Flux High: 230LM Low: 160LM
 COB Luminous Flux White: 150LM
 LED Continuous Operating Time High: 4H*, Low: 6H*
 COB Continuous Operating Time White: 6H*

5 Lighting Modes

LED Search Lamp Modes:



COB Area Lantern Modes:

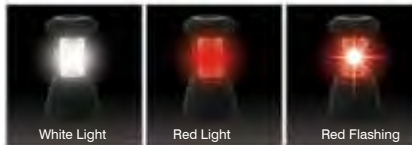

S32-3R6PCB



Specifications

Model#	LEDs	LED Type	Luminous Flux	Battery Mode	Body Material	Available Colors	Water Resistant (Y/N)
S32	1	3W COB LED	230lm	3 x AA	Plastic	Black	N

Packaging Details

Item#	Packaging Type	Included Batteries	Blister/Box Details				Outer Carton Details						
			Dimensions (mm)			Net Weight (g)	Packs/ Carton	Dimensions (cm)			Volume (M³)	Gross Weight (Kg)	Net Weight (kg)
			L Length	W Width	D Depth			L Length	W Width	H Height			
S32-3R6PCB	Color Box	3 x R6P	185	105	148	350	6	38.5	33	16.8	0.0214	2.6	2.35

Professional Work Light



Best for: Professionals, Camping, Outdoors, Caving use

S20

Main Features

- Powerful 8W COB LED illumination
- Two lighting modes - high beam / low beam
- 360° rotatable bracket, can adjust to any direction, convenient to hand carry or put on table
- Special coating applied, for a better appearance and smoother to handle
- Long Lifespan COB: needs no replacement, extremely energy saving

Specifications

- Power Source: Li-ion 18650, 3.7V, 4000mAh
- Light Source: 8W COB LED
- Luminous Flux:
High: 500LM Low: 300LM
- Continuous Operating Time:
High: 2hrs Low: 5hrs
- Dimensions: 225 x 195 x 58mm
- Accessories: USB charging cable L=1.2M

S21

Main Features

- Rechargeable - powered by a built-in rechargeable 2200mAh Li-ion battery pack
- Portable and Lightweight - equipped with a handle and a detachable stand, easy to carry, place it with the stand or hanging for camping
- Weatherproof - excellent outdoor performance with 360° rotating and weatherproof function
- Adjustable handle and stand - 360° rotatable, can easily be adjusted according to your requirements

Specifications

- Power Source: Li-ion 18650, 7.4V, 2200mAh
- Input: DC 8.4V, 1A max
- Charging Time: Approx. 3hrs
- Light Source: 10W COB
- Color Temperature: 6000K - 6500K
- Luminous Flux: 800LM
- Beam Angle: 120°
- Running Time: 4hrs
- Ingress Protection: IP65
- Dimension: 123 x 132 x 250mm
- Accessories: wall charger and car charger

S22

Main Features

- Rechargeable - powered by a built-in rechargeable 4400mAh Li-ion battery pack
- Portable and Lightweight - equipped with a handle and a detachable stand, easy to carry, place it with the stand or hanging for camping
- Weatherproof - excellent outdoor performance with 360° rotating and weatherproof function
- Adjustable handle and stand - 360° rotatable, can easily be adjusted according to your requirements

Specifications

- Power Source: Li-ion 18650, 7.4V, 4400mAh
- Input: DC 8.4V, 1A max
- Charging Time: Approx. 6hrs
- Light Source: 20W COB
- Color Temperature: 6000K - 6500K
- Luminous Flux: 1600LM
- Beam Angle: 120°
- Running Time: 4hrs
- Ingress Protection: IP65
- Dimension: 163 x 163 x 300mm
- Accessories: wall charger and car charger

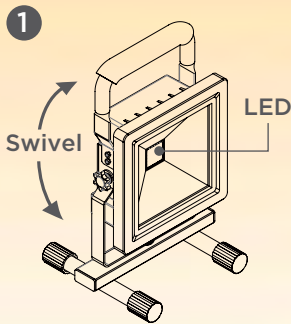

S22



S22-CB

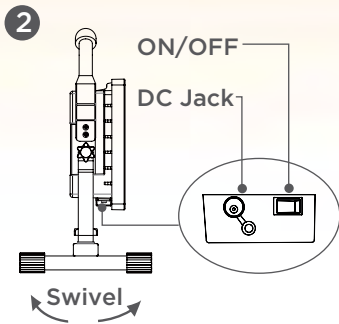

S21



S21-CB

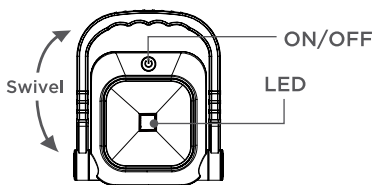

S20



S20-CB



Model#	LED Type	Luminous Flux	Battery Mode	Body Material	Available Colors	Water Resistant (Y/N)
S20	8W COB LED	500lm	Li-ion 18650	Plastic	Black	N
S21	10W COB LED	800lm	Li-ion 18650	Plastic	Yellow	Y
S22	20W COB LED	1600lm	Li-ion 18650	Plastic	Red	Y

Packaging Details

Item#	Packaging Type	Included Batteries	Blister/Box Details					Outer Carton Details					
			Dimensions (mm)			Net Weight (g)	Packs/ Carton	Dimensions (cm)			Volume (M ³)	Gross Weight (Kg)	Net Weight (kg)
			L Length	W Width	D Depth			L Length	W Width	H Height			
S20-CB	Color Box	Li-ion 18650	205	75	240	600	12	47	42.5	26	0.0519	7.7	7.2
S21-CB	Color Box	Li-ion 18650	130	110	225	1100	12	45.5	40.5	24.5	0.0451	14.2	13.2
S22-CB	Color Box	Li-ion 18650	170	120	270	1600	10	61.5	35.5	29	0.0633	17	16

Domestic Lighting

Ideal Lighting for Household

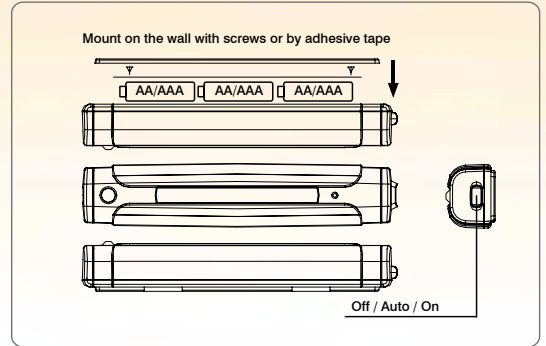

Sensor Light

- Wide Sensory Angles
- Long sensory distance
- Choice of installation by adhesive tape or screws
- Detachable body from the mounted base

Best for:

Bedrooms, hallways, Staircase, washroom, closets and drawers



SL7018-3R6TB



Specifications

Model#	Bulb Type	Luminous Flux	Battery Mode	Body Material	Available Colors	Water Resistant (Y/N)
SL7018	Super Bright LED	15lm	3 x AA	Plastic	☐ White	N

Packaging Details

Item#	Packaging Type	Included Batteries	Blister/Box Details				Outer Carton Details						
			Dimensions (mm)			Net Weight (g)	Packs/ Carton	Dimensions (cm)			Volume (M ³)	Gross Weight (Kg)	Net Weight (kg)
			L Length	W Width	D Depth			L Length	W Width	H Height			
SL7018-3R6TB	Blister Pack	3 x R6P	190	110	48	139	48	52.5	44.5	21.5	0.0502	7.9	6.7

Flashlights Replacement Bulbs

LED

Replace
Krypton and LED Bulbs
Energy Saving

Lifetime Up to 10,000 Hours

3V 4.5V 6V

2x Batteries 3x Batteries 4x Batteries



3V

4.5V

6V

Specifications

Model No.	Lamp Type	Voltage (V)	Current (mA)	Power (W)	Luminous Flux (lm)	Color Temperature (K)	Base Type	Average Life (hrs)	Battery Type
BL304 WN	LED Flashlight Bulb	3.0	130	0.4	30	6000--8000 (Cool White)	P 13.5S	10,000	2x(AA/AAA/D/C)
BL406 WN	LED Flashlight Bulb	4.5	130	0.6	38	6000--8000 (Cool White)	P 13.5S	10,000	3x(AA/AAA/D/C) 3LR12,3R12
BL608 WN	LED Flashlight Bulb	6.0	130	0.8	42	6000--8000 (Cool White)	P 13.5S	10,000	4x(AA/AAA/D/C), 4R25

Packaging Details

Pack. Picture	Name	Item #	Packaging Type	Blister/Box Details			Net Weight (g)	Packs/ Carton	Outer Carton Details					
				Dimensions (mm)					Dimensions (cm)			Volume (M ³)	Gross Weight (Kg)	Net Weight (kg)
				L Length	W Width	D Depth			L Length	W Width	D Depth			
	LED Replacement Bulbs	BL304WN-BP1	Blister Pack	92	55	14	6	480	30.5	30	24.8	0.0227	4.4	2.4
		BL406WN-BP1		92	55	14	6	480	30.5	30	24.8	0.0227	4.4	2.4
		BL608WN-BP1		92	55	14	6	480	30.5	30	24.8	0.0227	4.4	2.4

Promotional Accessories



Sales Promotional Material

Maximum Impact, Minimum Space, Optimal Sales

When you want your Camelion products to have maximum impact you need optimal POP promotional material.

For the latest sales accessories and premiums please contact us at info@camelion.com

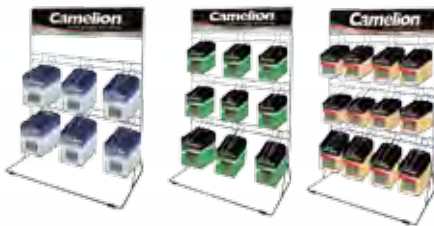

WCD-02

WCD-03

WCD-05

Metal Counter Display

- WCD-02: 33 x 43 x 22cm (6 hooks)
- WCD-03: 33 x 58 x 22cm (9 hooks)
- WCD-05: 44 x 66 x 20cm (12 hook)
- Sturdy steel construction for long use
- Easy to see, easy to reach
- Light weight for easy portability
- Available in Metal Black



WCD-06

Metal Counter Display

- 10 Racks 20 hooks L = 12,5cm
- Simple and lightweight design
- Dimensions: W x H x D: 30x158x35cm

Qty for Each Hook:

- AAA Size: 10packs
- AA Size: 7packs
- 9V Size: 6packs
- C Size: 5packs
- D Size: 4packs



Metal Counter Display

MFD-02

- Use metal racks to expand each peg
- Professional slim and elegant design
- Rugged steel construction for long life
- Easy assembly by interlocking joints, no screws or hammers (Instructions included)
- W x H x D: 46 x 70 x 26cm



Metal Floor Display

MFD-03

- Up to 300-400 peg holes (ideally holds 20-30 large / medium size packages)
- Use metal racks to expand each peg
- Professional slim and elegant design
- Rugged steel construction for long life
- Easy assembly by interlocking joints, no screws or hammers (Instructions included)
- W x H x D: 80x180x61cm



Metal Floor Display

MFD-06

Rugged steel construction for long life

With this display you present your Camelion products appealing and clear. The lightly curved floor display focusses attention directly to the product assortment, and moreover emphasizes the Camelion brand - a major boost for a positive purchase decision.

B x H x T: 107 x 177 x 33cm

Display Box



DR16 Promotion Display "8+4 free"

- Plus Alkaline floor display for promotion blister "8+4 free" (AA | AAA)
- Height (total) 1,17m + palett
- Width 0,55m
- Depth 0,38m
- Material Cardboard
- Surface shiny
- 12x grids = 12 storage compartments
- 48x LR6 „8+4 free“ (8 storage compartments)
6 blister per storage compartment
- 36 x LR03 „8+4 free“ (4 storage compartments)
- 84 blister total



Plus Alkaline LR6 BP8+4
Art. Nr. 110 84006
EAN 4260216453915
carton 48 / innerbox 6



Plus Alkaline LR03 BP8+4
Art. Nr. 110 84003
EAN 4260216453922
carton 72 / innerbox 6



DR16 Promotion Display "24"

- Plus Alkaline floor display for plastic box "24" (AA | AAA)
- Height (total) 1,17m + palett
- Width 0,55m
- Depth 0,38m
- Material Cardboard
- Surface shiny
- 32x grids = 32 storage compartments
- 60 x LR6 „24“ (20 storage compartments)
3 boxes per storage compartment
- 48 x LR03 „24“ (12 storage compartments)
4 boxes per storage compartment
- 108 boxes total



Plus Alkaline LR6 PB24
Art. Nr. 111 02406
EAN 4260033150455
carton 30 / innerbox 6



Plus Alkaline LR03 PB24
Art. Nr. 111 02403
EAN 4260033150462
carton 30 / innerbox 6



Desktop Acrylic Display Stand

ADS-01

- Compact Size suitable on the shelf or near the cashier
- 15 Flexible hooks for different series of products (hook: L=5cm)
- Dimensions (W x H x D): 345x 480x135mm(*8 Depth) 75°
- Elegant design : Economical and versatile
- Durable and light : Made by acrylic material

Six Options:





DR-11

DR-12

Battery Aisle Display Box

- Battery shaped floorstand trigger and strengthen brand recognition
- Brand space maximized through strong printed graphics
- Strong structural integrity for easy moving
- Ideal for most retail markets placement
- DR11: W x H x D: 60 x 158 x 31 cm
- DR12: W x H x D: 42 x 70.5 x 21 cm

The AlwaysReady and Digi Alkaline Speaker



SPK-01

SPK-02

The AlwaysReady and Digi Alkaline Speaker deliver impressive volume and clarity, it is small enough to fit in your pocket and uses a standard headphone jack to connect to your music device, ideally effortless amplify your favorite tunes via any iPhone, iPod, MP3/4 player, Smartphone, or laptop.



Ball Pen

PN-04R



Ball Pen

PN-04B



Paper Bag

PB-01

- Material: paper
- W x H x D: 54x14x44.5cm



Non Woven Bag

HB-04

- Material: fiber
- W x H x D: 38x34x10cm



Caps

C-01

Comfortable golf caps with all-size fits design, in trendy corporate colors.

Camelion catalogue 2018 register

PAGE	PRODUCT	Art.No.	EAN Barcode	PAGE	PRODUCT	Art.No.	EAN Barcode	PAGE	PRODUCT	Art.No.	EAN Barcode
LITHIUM P7 / 9V LITHIUM BATTERIES				14	R14P-BP2B	102 00214	4260033151025	19	CR2477-BP1	130 01477	4260216455353
6	FR6-BP2	190 00206	4260033154859	14	R6P-BP4B	102 00406	4260033151049	19	CR927-BP1	130 01927	4260216452475
6	FR03-BP2	190 00203	4260033154873	14	R03P-BP4B	102 00403	4260033151070	19	CR1216-BP5	130 05216	4260033152718
6	ER9-BP1	190 00122	4260216450334	14	R6P-HP12B	102 01206	4260033151438	19	CR1220-BP5	130 05122	4260033152701
6	ER9-SP1	191 00122	4260216455599	14	6F22-BP1B	102 00122	4260033151094	19	CR1225-BP5	130 05225	4260033152695
DIGI ALKALINE / BLISTER				14	R6P-HP12B	102 01206	4260033151438	19	CR1616-BP5	130 05161	4260033152688
7	LR20-BP2DG	112 10220	4260216453885	14	4R25-SP1B	101 10125	4260033153531	19	CR1620-BP5	130 05620	4260033152671
7	LR14-BP2DG	112 10214	4260216453892	SUPER HEAVY DUTY GREEN				19	CR1632-BP5	130 05632	4260216455797
7	LR6-BP4DG	112 10406	4260033154521	15	R20-BP2G	100 00220	4260033156280	19	CR2016-BP5	130 05016	4260033152664
7	LR6-BP2DG	112 10206	4260033154538	15	R20-BP4G	100 00420	4260033156358	19	CR2025-BP5	130 05025	4260033152657
7	LR03-BP4DG	112 10403	4260033154545	15	R14-BP2G	100 00214	4260033156297	19	CR2032-BP5	130 05032	4260033152640
7	LR03-BP2DG	112 10203	4260033154552	15	R14-BP4G	100 00414	4260033156389	19	CR2430-BP5	130 05430	4260216455803
7	6LR61-BP1DG	112 10122	4260216454028	15	R14-BP6G	100 00614	4260033150936	19	CR2450-BP5	130 05450	4260216455810
PLUS ALKALINE				15	R6-BP8G	100 00806	4260033156402	19	CRVPO1-BP6	130 00600	4260216456145
8	LR20-BP2	110 00220	4260033150004	15	R6-BP4G	100 00406	4260033156303	MICRO BATTERIES ALKALINE			
8	LR14-BP2	110 00214	4260033150011	15	R6-BP10G	100 01006	4260033156396	20	AG1-BP2 (0%HG)	120 50201	4260216454783
8	LR6-BP4	110 00406	4260033150028	15	R03-BP4G	100 00403	4260033156327	20	AG2-BP2 (0%HG)	120 50202	4260216454790
8	LR6-BP2	110 00206	4260033150035	15	R03-BP8G	100 00803	4260033156426	20	AG3-BP2 (0%HG)	120 50203	4260216454806
8	4+4LR6	110 44806	4260216451096	16	6F22-BP1G	100 00122	4260033156341	20	AG4-BP2 (0%HG)	120 50204	4260216454622
8	LR6-HP12	110 01206	4260033150424	16	6F22-BP2G	100 00222	4260033156365	20	AG5-BP2 (0%HG)	120 50205	4260216454813
8	LR6-BP10	110 01006	4260033150097	16	3R12-BP1G	100 00112	4260033156372	20	AG6-BP2 (0%HG)	120 50206	4260216454820
8	LR03-BP2	110 00203	4260033150059	16	2R10-BP1G	100 00110	4260033150943	20	AG7-BP2 (0%HG)	120 50207	4260216454837
9	LR03-BP4	110 00403	4260033150042	16	R20-SP2G	101 00220	4260033156433	20	AG8-BP2 (0%HG)	120 50208	4260216454844
9	4+4LR03	110 44803	4260216451102	16	R14-SP2G	101 00214	4260033156440	20	AG9-BP2 (0%HG)	120 50209	4260216454851
9	LR03-BP10	110 01003	4260033150103	16	R6-SP2G	101 00206	4260033156464	20	AG10-BP2 (0%HG)	120 50210	4260216454608
9	6LR61-BP1	110 00122	4260033150066	16	R6-SP4G	101 00406	4260033156457	20	AG11-BP2 (0%HG)	120 50211	4260216454868
9	LR1-BP2	110 00201	4260033150080	16	R03-SP2G	101 00203	4260033156488	20	AG12-BP2 (0%HG)	120 50212	4260216454875
9	LR1-BP5	110 00501	4260216455780	16	R03-SP4G	101 00403	4260033156471	20	AG13-BP2 (0%HG)	120 50213	4260216454615
9	LR61-BP2	110 00261	4260033150295	17	6F22-SP1G	101 00122	4260033156495	20	625A-BP1 (0%HG)	120 50125	4260216454882
9	3LR12-BP1	110 00112	4260033150073	17	4R25-SP1G	10100125	4260033156211	20	AG0-BP10 (0%HG)	120 51000	4260216454899
9	LR6 bulk	110 90006	-	17	3R12-SP1G	10100112	4260033156501	20	AG1-BP10 (0%HG)	120 51001	4260216454905
9	LR03 bulk	110 90003	-	17	FPG-GB40	101 04000	4260033150905	20	AG2-BP10 (0%HG)	120 51002	4260216454912
10	LR6-SP40HFB	111 04006	4260216456428	17	4+2R6PG-BP	100 42606	4260216456138	20	AG3-BP10 (0%HG)	120 51003	4260216454929
10	LR03-SP40HFB	111 04003	4260216456435	17	4+2R03PG-BP	100 42603	4260216456121	20	AG4-BP10 (0%HG)	120 51004	4260216454400
10	LR6-SP2	111 00206	4260033150332	17	R6-SP8G	101 08006	4260216451118	20	AG5-BP10 (0%HG)	120 51005	4260216454936
10	LR6-SP4	111 00406	4260033150325	17	R03-SP8G	101 08003	4260216451188	20	AG6-BP10 (0%HG)	120 51006	4260216454943
10	LR03-SP2	111 00203	4260033150356	18	R6-SP12G	101 01206	4260033156266	20	AG7-BP10 (0%HG)	120 51007	4260216454950
10	LR03-SP4	111 00403	4260033150349	18	R03-SP12G	101 01203	4260216451199	20	AG8-BP10 (0%HG)	120 51008	4260216454967
10	LR14-SP2	111 00214	4260033150318	PHOTO LITHIUM BATTERIES				20	AG9-BP10 (0%HG)	120 51009	4260216454974
10	LR20-SP2	111 00220	4260033150301	18	CR123A-BP1	190 01123	4260033153364	20	AG10-BP10 (0%HG)	120 51010	4260216454981
10	6LR61-SP1	111 00122	4260033150363	18	CR123A-BP2	190 02123	4260216456688	20	AG11-BP10 (0%HG)	120 51011	4260216454998
10	3LR12-SP1	111 00112	4260033150370	18	2CR5-BP1	190 01125	4260033153395	20	AG12-BP10 (0%HG)	120 51012	4260216455001
11	LR6-PB24	111 02406	4260033150455	18	CR-P2-BP1	190 01152	4260033153371	20	AG13-BP10 (0%HG)	120 51013	4260216455018
11	LR03-PB24	111 02403	4260033150462	18	CR2-BP1	190 01142	4260033153388	21	A11-BP1 (0%HG)	110 50111	4260216455049
11	LR6-PB20	111 02006	4260216453106	MICRO BATTERIES LITHIUM				21	A23-BP1 (0%HG)	110 50123	4260216455056
11	LR03-PB20	111 02003	4260216453113	19	CR1216-BP1	130 01216	4260033152831	21	A27-BP1 (0%HG)	110 50127	4260216455063
11	6LR61-PB6	111 00622	4260033150479	19	CR1220-BP1	130 01122	4260033152824	21	A32-BP1 (0%HG)	110 50132	4260216455070
11	LR6-PBH24	111 12406	4260033155092	19	CR1225-BP1	130 01225	4260033152817	21	A23-BP5 (0%HG)	110 50523	4260216455087
11	LR03-PBH24	111 12403	4260033155108	19	CR1616-BP1	130 01161	4260033152800	21	A27-BP5 (0%HG)	110 50527	4260216455094
11	CM-FA-01	111 00029	4260033155160	19	CR1620-BP1	130 01620	4260033152794	21	4LR44-BP1 (0%HG)	120 50144	4260216455025
12	LR6-SP10-DA	111 01006	4260033157249	19	CR1632-BP1	130 01632	4260033152923	21	4LR44-BP5 (0%HG)	120 50544	4260216455827
12	LR03-SP10-DA	111 01003	4260033157256	19	CR2016-BP1	130 01016	4260033152787	21	4LR43-BP1 (0%HG)	120 00143	4260216455025
LIMITED EDITION				19	CR2025-BP1	130 01025	4260033152770	HEARING AID ZINC AIR			
12	10+2-LR6-DA	111 01206	4260216456643	19	CR2032-BP1	130 01032	4260033152763	22	A13-BP6 (0%HG)	150 56013	4260030253975
12	10+2-LR03-DA	111 01203	4260216456650	19	CR2320-BP1	130 01320	4260033152756	22	A10-BP6 (0%HG)	150 56010	4260030253968
13	8+4LR6-BP	110 84006	4260216453915	19	CR2330-BP1	130 01330	4260033152749	22	A675-BP6 (0%HG)	150 56675	4260030253999
13	8+4LR03-BP	110 84003	4260216453922	19	CR2325-BP1	130 01325	4260033152848	22	A312-BP6 (0%HG)	150 56312	4260030253982
SUPER HEAVY DUTY BLUE				19	CR2430-BP1	130 01430	4260033152732				
14	R20P-BP2B	102 00220	4260033151018	19	CR2450-BP1	130 01450	4260033152725				

PAGE	PRODUCT	Art.No.	EAN Barcode
SILVER OXIDE			
22	SR41-BP1 (0%HG)	140 51041	4260216455117
22	SR43-BP1 (0%HG)	140 51043	4260216455124
22	SR44-BP1 (0%HG)	140 51044	4260216455131
22	SR54-BP1 (0%HG)	140 51054	4260216455148
22	SR57-BP1 (0%HG)	140 51057	4260216455155
22	SR58-BP1 (0%HG)	140 51058	4260216455162
22	SR59-BP1 (0%HG)	140 51059	4260216455179
22	SR60-BP1 (0%HG)	140 51060	4260216455186
22	SR63-BP1 (0%HG)	140 51063	4260216455193
22	SR66-BP1 (0%HG)	140 51066	4260216455209
22	SR69-BP1 (0%HG)	140 51069	4260216455216
22	SR41-BP5 (0%HG)	140 55041	4260216455223
22	SR43-BP5 (0%HG)	140 55043	4260216455230
22	SR44-BP5 (0%HG)	140 55044	4260216455247
22	SR54-BP5 (0%HG)	140 55054	4260216455254
22	SR57-BP5 (0%HG)	140 55057	4260216455261
22	SR58-BP5 (0%HG)	140 55058	4260216455278
22	SR59-BP5 (0%HG)	140 55059	4260216455285
22	SR60-BP5 (0%HG)	140 55060	4260216455292
22	SR63-BP5 (0%HG)	140 55063	4260216455308
22	SR66-BP5 (0%HG)	140 55066	4260216455315
22	SR69-BP5 (0%HG)	140 55069	4260216455322
22	4SR44-BP1 (0%HG)	140 51444	4260216455032
22	4SR44-Bulk (0%HG)	140 52444	-
BATTERY ADAPTER & CASES			
23	Battery Case for 4x AAA/AA Batteries & Rechargeable	500 00001	4260033157539
23	Battery Case for 4x AAA/AA Batteries & Rechargeable	500 00002	4260033157539
23	Plastic Box for 24x AA PB24	501 00017	
23	Plastic Box for 24x AAA PB24	501 00018	
23	Adapter Plastic for C size (Color: white)	999 00014	4260033157546
23	Adaptor Plastic for D size / D (Color: white)	999 00020	4260033157553
23	Adapter Aluminium for C size	999 10014	4260033156518
23	Adaptor Aluminium for D size	999 10020	4260033156525
BATTERY TESTER			
23	BT-503	203 00503	4260033157508
ALWAYS READY			
26	NH-AA2500ARBP2	174 25206	4260216453038
26	NH-9V200ARBP1	174 20122	4260033155221
26	NH-AA2300ARBP2	174 23206	4260033152336
26	NH-AA2300ARBP4	174 23406	4260033154040
26	NH-AAA800ARBP2	174 08203	4260033152305
26	NH-AAA800ARBP4	174 08403	4260033152312
27	NH-AA800ARBP2	174 08206	4260216453236
27	NH-AA600ARBP4(GSL)	174 06406	4260216455667
27	NH-AA600ARBP4(GSL)	174 06403	4260216455674
NI-MH RECHARGEABLE BATTERIES			
28	NH-D1000BP2	170 10220	4260033151865
28	NH-D7000BP2	170 70220	4260033151520
28	NH-D2500BP2	170 25220	4260033151537
28	NH-C3500BP2	170 35214	4260033151544
28	NH-C2500BP2	170 25214	4260033151551
28	NH-AA2700BP4	170 27406	4260033151933
28	NH-AA2700BP2	170 27206	4260033151926
29	NH-AA2500BP4	170 25406	4260033151834

PAGE	PRODUCT	Art.No.	EAN Barcode
29	NH-AA2500BP2	170 25206	4260033151827
29	NH-AA2300BP4	170 23406	4260033151742
29	NH-AA2300BP2	170 23206	4260033151735
29	NH-AA2000BP2	170 20206	4260033151582
29	NH-AA1800BP4	170 18406	4260033151612
29	NH-AA1800BP2	170 18206	4260033151605
29	NH-AA1500BP2	170 15206	4260033151629
30	NH-AAA1100BP4	170 11403	4260033151957
30	NH-AAA1100BP2	170 11203	4260033151940
30	NH-AAA1000BP4	170 10403	4260033151889
30	NH-AAA1000BP2	170 10203	4260033151872
30	NH-AAA900BP4	170 09403	4260033151766
30	NH-AAA900BP2	170 09203	4260033151759
30	NH-AAA800BP2	170 08203	4260033151667
31	NH-AAA600BP4	170 06403	4260033151711
31	NH-AAA600BP2	170 06203	4260033151704
31	NH-9V250BP1	170 25122	4260033151810
31	NH-9V200BP1	170 20122	4260033151728
HEARING AID ZINC AIR			
31	ICR18650F-26bulk	17802600	
31	ICR18650F-22bulk	17802200	
ULTRA FAST CHARGER			
33	BC-0907	200 00907	4260033157706
33	BC-0907-UK Plug	200 01907	4260216456640
SUPER FAST CHARGER			
34	BC-0905A with UK Plug	200 01905	4260033157812
FAST CHARGER			
35	BC-1010B	20101010	4260216456473
36	BC-1002A with UK Plug	201 01002	4260216456497
37	BC-1012	201 01012	4260216453199
OVERNIGHT CHARGER			
38	BC-1001A	200 01001	4260033158260
38	BC-1001A with UK Plug	201 01001	4260216456480
39	BC-0904S	200 00904	4260033157850
40	BC-0901	20000901	4260033157867
UNIVERSAL CHARGER			
41	CM-9398	200 09398	4260030259403
42	CM-3298	200 03298	4260030255900
43	CM-9388	200 09388	4260033158512
44	LBC-312	200 00312	4260216452994
45	LBC-313-1	20003131	4260216456756
LITHIUM-ION CHARGER			
46	LBC-305	20000305	4260216456763
PROFESSIONAL CHARGER			
47	CM-500	200 00500	4260030255917
POWERBANKS			
51	PS675	20200675	4260216456282
51	PS679	20200679	4260216456817
USB POWER ADAPTERS			
52	AD568-DB	200 00568	4260216455476
52	AD569-DB	200 00569	4260216454769
USB CAR CHARGE			
53	DD801	202 00801	4260216452550
53	DD802	202 00802	4260216450563
54	DD823	20200823	4260216456343
USB CHARGER-SET			
54	3 in 1 USB Charger Set	200 00123	4260216456411

PAGE	PRODUCT	Art.No.	EAN Barcode
LED FLASHLIGHTS			
57	FL6L2D2R20P	302 00040	4260216452796
58	FL1L2DR20P	302 00026	4260033155542
58	FL1L2DD12	302 00043	4260033155610
58	FL1L2CB2R14P	302 00045	4260216454677
58	FL1L2AA2R6P	302 00025	4260033155566
58	FL1L2AAD24	302 00044	4260033155603
60	FL-16LED	302 00033	4260033155504
60	FL-9LED	302 00034	4260033155481
60	CM25L	30200054	4260216456770
62	SL3013 LED Key Chain	302 00047	4260216456084
62	SL3013 LED Key Chain in Fishbowl with 36x pieces	302 00046	4260216454059
64	HP7011-3R03PBP	302 00028	4260216450136
64	PT1L2D-2R6PBP	302 00053	4260216456381
64	PT1L2AA-2R6PBP	302 00052	4260216456374
66	DL2AAAS Aluminium Doctor Penlight incl. 2x CAM. Super Heavy Duty AAA batteries BLUE / blister	300 00017	4260033154347
67	T11-3R03PD12	302 00051	4260216456244
LED FLASHLIGHTS CT-SERIES			
68	CT4004	302 00011	4260030255733
68	CT4005	302 00008	4260030255740
68	CT4010	30200027	4260030255795
70	36x LED SOLAR Lantern powered by Solar or 4 x R20 batteries (not included)	302 00012	4260030255474
70	CT4008	302 00024	4260030255771
70	CT4007	302 00023	4260030255764
COB LED WORK LIGHTS			
72	SL5240N-3R6PD12	302 00049	4260216456152
72	SL7280N-3R03PD12	302 00048	4260216456169
74	S31-D12	30200056	4260216456534
75	S32 2in1 Spotlight	30200055	4260216456718
76	S20 10W COB LED Worklight	30200057	4260216456800
76	S21 10W COB LED Floodlight	30200058	4260216456787
76	S22 20W COB LED Floodlight	30200059	4260216456794
78	SL7018-3R6TB	302 00050	4260216456312
LED REPLACEMENT BULBS			
79	BL304WN		
79	BL406WN		
79	BL608WN		
BATTERY STANDS (FLOOR DISPLAYS / WIRE COUNTER DISPLAYS / STRIP)			
81	WCD-02 Wire Counter Displays 6-hooks	501 00006	-
81	WCD 03 Wire Counter Display 9 hooks	501 00007	-
81	WCD-06 Floor Display 20-hooks	501 00015	-
81	MFD-02 Wire Counter Displays 16-hooks	501 00003	-
81	MFD 03 Floor Display 36 hooks	501 00001	-
81	MFD-06 Floor Display 80 hooks	501 00021	-
82	DR-16 8+4 Free	50100029	
82	DR-16 24	50100028	
82	ADS-01 Acrylic Counter Display 15-hooks	501 00019	-
83	DR-11 Battery-Aisle Display Box 28 hooks H x W = 160 x 65cm	501 00020	-
83	DR-12 Battery-Aisle Display Box 9 hooks H x W = 70 x 32cm	501 00025	-
83	various Promotional Accessories	501 00004	-

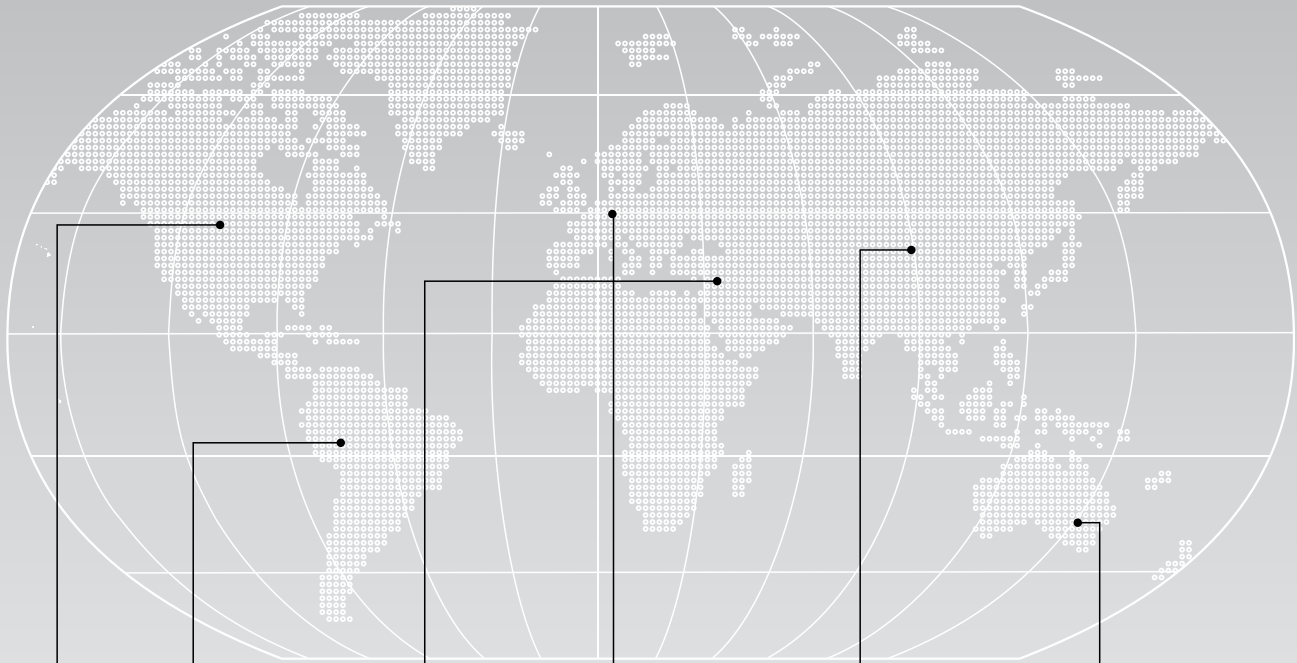

- North America**
- Canada
 - U. S. A

- Caribbean/
Latin America**
- Argentina
 - Brazil
 - Bolivia
 - Chile
 - Colombia
 - Costa Rica
 - Cuba
 - Dominica
 - Ecuador
 - EL Salvador
 - Guatemala
 - Haiti
 - Mexico
 - Nicaragua
 - Panama
 - Paraguay
 - Peru
 - Puerto Rico
 - Trinidad and Tobago
 - Uruguay
 - Venezuela

- Middle East
/Africa**
- Algeria
 - Benin
 - Egypt
 - Iran
 - Israel
 - Kuwait
 - Lebanon
 - Sierra Leone
 - Saudi Arabia
 - Syria
 - S. Africa
 - Tunisia
 - U.A.E.
 - Uganda

- Europe**
- Austria
 - Albania
 - Andorra
 - Belarus
 - Belgium
 - Bosnia
 - Bulgaria
 - Czech Republic
 - Croatia
 - Cyprus
 - Denmark
 - Estonia
 - Finland
 - France
 - Germany
 - Georgia
 - Greece
 - Hungary
 - Iceland
 - Ireland
 - Italy
 - Latvia
 - Lithuania
 - Luxembourg
 - Macedonia
 - Malta
 - Netherland
 - Norway
 - Portugal
 - Poland
 - Romania
 - Russia
 - Serbia
 - Slovakia
 - Slovenia
 - Spain
 - Sweden
 - Switzerland
 - Turkey
 - United Kingdom
 - Ukraine

- Asia**
- Afghanistan
 - Armenia
 - Azerbaijan
 - Bangladesh
 - Cambodia
 - China
 - Hong Kong
 - India
 - Iraq
 - Japan
 - Jordan
 - Korea
 - Kazakhstan
 - Laos
 - Malaysia
 - Pakistan
 - Philippines
 - Singapore
 - Sri Lanka
 - Taiwan
 - Thailand
 - Turkmenistan
 - Vietnam
 - Yemen

- Oceania**
- Australia
 - Fiji
 - New Zealand

EUROPE HEAD OFFICE / WAREHOUSE

Camelion Batterien GmbH.
Bergiusstr. 53-59, D-12057 Berlin,
Germany



 Camelion Batterien GmbH



For more information visit www.camelion.com

Copyright ©2018 Batterien GmbH, All rights reserved