

Produktkatalog 2018 | 2019



Camelion®
...for more energy

BATTERIEN • AKKUS • LADEGERÄTE • POWERBANKS • TASCHENLAMPEN

www.camelion.com



BATTERIEN • AKKUS • LADEGERÄTE • POWERBANKS • TASCHENLAMPEN

Inhaltsverzeichnis

Primäre Batterien

Lithium	6
9V Lithium	6
Digi Alkaline	7
Plus Alkaline	8
Super Heavy Duty (Blau)	14
Super Heavy Duty (Grün)	15
Foto Lithium	18

Knopfzellen

Lithium Knopfzellen	19
Alkaline Knopfzellen	20
Remote Control Batterien	21
Silber-Oxyd Knopfzellen	22
Zink-Luft Knopfzellen	22
Batterie Aufbewahrungsbox, Batterie Adapter, Batterietester	23
Anwendungstabelle Batterie	24

Akkus

AlwaysReady™ Ni-MH Akkus	26
Ni-MH Akkus	28
Lithium-Ion Akkus	31

Akku Ladegeräte

Ultra Schnell Ladegerät	
BC-0907	33
Super Schnell Ladegeräte	
BC-0905A	34
BC-1010B	35
Schnell Ladegeräte	
BC-1002A	36
BC-1012	37
Steckerladegeräte	
BC-1001A	38
BC-0904S	39
BC-0901	40

Universal Ladegeräte

CM9398GS	41
CM3298	42
CM9388	43
LBC-312	44
LBC-313-1	45

Lithium-Ion Ladegeräte

LBC-305	46
CM500	47

Akku Ladetabelle	48
-------------------------	-----------

USB Steckeradapter

Power Banks

PS675, PS679 **51**

USB Steckeradapter

AD568, AD569 **52**

USB KFZ Ladeadapter

DD801, DD802 **53**

DD823 **54**

3in1 USB Ladeset

AD568+DD811+CDC015 **54**

Anwendungstabelle **55**

Batteriebetriebene Taschenlampen

SuperBright™ Taschenlampen

Multi-Head Klassische Taschenlampe

FL6L2D **57**

Klassische Taschenlampen

FL1L2D, FL1L2C, FL1L2AA **58**

Multi-Head LED Handscheinwerfer

FL-16LED, FL-9LED **60**

LED Handscheinwerfer

CM25L **60**

Schlüsselanhänger

SL3013 **62**

TRAVLite™ Taschenlampen

Hosentaschen LED Taschenlampe

HP7011 **64**

Gummi LED Taschenlampen

PT1L2D, PT1L2AA **64**

Profi Produkte

Penlight Taschenlampe

DL2AAAS **66**

Inspektionsleuchte

T11 **67**

CT-Serie LED Taschenlampen

Hochwertige Aluminium Taschenlampen mit maximaler Beleuchtungsstärke

CT4004, CT4005, CT4010 **68**

LED Laternen

Solar Laterne, CT4008 **70**

3 Watt Kopflampe

CT4007 **70**

Werkstattleuchte

SL5240N **72**

Multi Light 2 in 1

SL7280N **72**

3 Watt COB LED

S31 **74**

2-IN-1 Spotlight

S32 **75**

Profi Werkstattleuchten

S20, S21, S22 **76**

Haushaltsleuchte

Sensorleuchte

SL7018 **78**

Ersatzbirnen für Taschenlampen

LED Ersatzbirnen **79**

Promotionartikel

80

Primäre Batterien



EMPORIO URTEIL	
Camelion Lithium AA	
GUT	81,7%
22 AA-Batterien im Vergleichstest	Hefz. 11/2008

Lithium P⁷ Batterien

Camelion Lithium P7™ Batterien zeichnen sich besonders durch ihre hohe Leistungsdichte, ihre lange Lebensdauer bzw. Lagerfähigkeit von bis zu 15 Jahren aus. Sie ist optimal geeignet für digitale Anwendungen (z. B. 7 x mehr Fotos als mit herkömmlichen Alkaline Batterien) und hält den Strom auf einem höheren konstanten Spannungsniveau (Langzeitstabilität); entsprechend hervorragend geeignet für Langzeitanwendungen. Die Lithiumbatterie P7 ist ca. 33 % leichter als eine herkömmliche Alkaline Batterie.



FR6-BP2

1.5V AA



Verpackung	2 St./Pack	Bruttogewicht:	9.3 kg
Blister	12 packs/box	Volumen:	0.0251 cbm
Verpackungseinheit	216 Packs/Karton		

Abmaße			
Blister (mm)	84(B) x 114(H) x 15(T)		
Verpackungseinheit (mm)	131(B) x 98(T) x 86(H)		
Umkarton (cm)	41.5(B) x 27.5(T) x 22.0(H)		



FR03-BP2

1.5V AAA



Verpackung	2 St./Pack	Bruttogewicht:	8.0 kg
Blister	12 Packs/Box	Volumen:	0.0237 cbm
Verpackungseinheit	288 Packs/Karton		

Abmaße			
Blister (mm)	84(B) x 114(H) x 15(T)		
Verpackungseinheit (mm)	119(B) x 75(T) x 86(H)		
Umkarton (cm)	32.5(B) x 26.0(T) x 28.0(H)		



9V Lithium

(Ist speziell für Rauchmelder entwickelt worden und bis zu 10 Jahren haltbar bzw. einsatzfähig!)

Die neue Lithium 9V Batterie von Camelion ist eine Batterie mit hoher Kapazität, entwickelt um lange Lebensdauer und stabile Betriebsspannung zu liefern.

- Bis zu 5x länger anhaltend *
- Geringe Selbstentladung
- Anti Auslaufausführung
- Temperaturbereich -20 °C bis +55 °C
- Nicht wiederaufladbar
- 10 Jahre Haltbarkeit
- hohe und stabile Betriebsspannung

*Im Vergleich zu Alkaline Batterien, Camelion 2010 Labortest.



ER9V-SP1

9V



Verpackung	1 St./Pack	Bruttogewicht:	14.5 kg
Shrink	20 Packs/Box	Volumen:	0.0083 cbm
Verpackungseinheit	200 Packs/Karton		

Abmaße			
Shrink (mm)	25.5(B) x 48.5(H) x 17.5 (T)		
Verpackungseinheit (mm)	145(B) x 74(T) x 54(H)		
Umkarton (cm)	39.0(B) x 17.5(T) x 13.5(H)		



ER9V-BP1

9V



Verpackung	1 St./Pack	Bruttogewicht:	8.3 kg
Blister	12 packs/box	Volumen:	0.0246 cbm
Verpackungseinheit	192 Packs/Karton		

Abmaße			
Blister (mm)	84(B) x 114(H) x 18(T)		
Verpackungseinheit (mm)	123(B) x 117(T) x 86(H)		
Umkarton (cm)	36.2(B) x 26.3(T) x 25.8(H)		



Digi Alkaline Batterien

Camelion Digi Alkaline Batterien halten durchschnittlich doppelt so lange wie herkömmliche Alkaline Batterien. Die richtige Batterie für Ihre höchsten Ansprüche speziell im digitalen Bereich. Beim Einsatz von CAMELION Digi Alkaline Batterien können bis zu 500 Bilder in Digitalkameras erzeugt werden.



LR20-BP2DG
1.5V D
4 260216 453885

Verpackung
Blister 2 St./Pack
Verpackungseinheit 6 Packs/Box
Umkarton 48 Packs/Karton

Bruttogewicht: 15.0 kg
Volumen: 0.0157 cbm

Abmaße
Blister (mm) 84(B) x 114(H) x 34(T)
Verpackungseinheit (mm) 160(B) x 110(T) x 92(H)
Umkarton (cm) 33.5(B) x 19.5(T) x 24.0(H)



LR14-BP2DG
1.5V C
4 260216 453892

Verpackung
Blister 2 St./Pack
Verpackungseinheit 6 Packs/Box
Umkarton 96 Packs/Karton

Bruttogewicht: 14.3 kg
Volumen: 0.0227 cbm

Abmaße
Blister (mm) 84(B) x 114(H) x 27(T)
Verpackungseinheit (mm) 140(B) x 90(T) x 92(H)
Umkarton (cm) 37.5(B) x 29.5(T) x 20.5(H)



LR6-BP4DG
1.5V AA
4 260033 154521

Verpackung
Blister 4 St./Pack
Verpackungseinheit 12 Packs/Box
Umkarton 144 Packs/Karton

Bruttogewicht: 15.4 kg
Volumen: 0.0166 cbm

Abmaße
Blister (mm) 84(B) x 114(H) x 15(T)
Verpackungseinheit (mm) 131(B) x 98(T) x 86(H)
Umkarton (cm) 27.5(B) x 28.0(T) x 21.5(H)



LR6-BP2DG
1.5V AA
4 260033 154538

Verpackung
Blister 2 St./Pack
Verpackungseinheit 12 Packs/Box
Umkarton 216 Packs/Karton

Bruttogewicht: 12.6 kg
Volumen: 0.0251 cbm

Abmaße
Blister (mm) 84(B) x 114(H) x 15(T)
Verpackungseinheit (mm) 131(B) x 98(T) x 86(H)
Umkarton (cm) 41.5(B) x 27.5(T) x 22.0(H)



LR03-BP4DG
1.5V AAA
4 260033 154545

Verpackung
Blister 4 St./Pack
Verpackungseinheit 12 Packs/Box
Umkarton 288 Packs/Karton

Bruttogewicht: 15.9 kg
Volumen: 0.0237 cbm

Abmaße
Blister (mm) 84(B) x 114(H) x 11(T)
Verpackungseinheit (mm) 119(B) x 75(T) x 86(H)
Umkarton (cm) 32.5(B) x 26.0(T) x 28.0(H)



LR03-BP2DG
1.5V AAA
4 260033 154552

Verpackung
Blister 2 St./Pack
Verpackungseinheit 12 Packs/Box
Umkarton 288 Packs/Karton

Bruttogewicht: 9.1 kg
Volumen: 0.0237 cbm

Abmaße
Blister (mm) 84(B) x 114(H) x 15(T)
Verpackungseinheit (mm) 119(B) x 75(T) x 86(H)
Umkarton (cm) 32.5(B) x 26.0(T) x 28.0(H)



6LR61-BP1DG
9V
4 260216 454028

Verpackung
Blister 1 St./Pack
Verpackungseinheit 12 Packs/Box
Umkarton 192 Packs/Karton

Bruttogewicht: 11.2 kg
Volumen: 0.0246 cbm

Abmaße
Blister (mm) 84(B) x 114(H) x 18(T)
Verpackungseinheit (mm) 123(B) x 117(T) x 86(H)
Umkarton (cm) 36.2(B) x 26.3(T) x 25.8(H)

Plus Alkaline Batterien

Camelion Plus Alkaline Batterien liefern einen hohen Strom, damit der Verbraucher sich durch den Einsatz in Fernbedienungen, Spielzeugen, Radios und anderen vielfältigen Geräten im Vergleich zur Zink Kohle Batterie länger erfreuen kann. Mit ihrer langlebigen Energie und ausgezeichneten Lagerfähigkeit ist sie ideal für die meisten elektronischen Anwendungen.

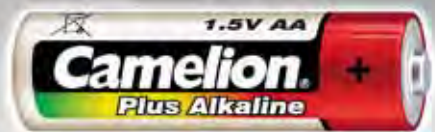

LR20-BP2

1.5V D



Verpackung	2 St./Pack	Bruttogewicht:	15.0 kg
Bliester	2 St./Pack	Volumen:	0.0157 cbm
Verpackungseinheit	6 Packs/Box		
Umkarton	48 Packs/Karton		

Abmaße	
Bliester (mm)	84(B) x 114(H) x 34(T)
Verpackungseinheit (mm)	160(B) x 110(T) x 92(H)
Umkarton (cm)	33.5(B) x 19.5(T) x 24.0(H)



LR14-BP2

1.5V C



Verpackung	2 St./Pack	Bruttogewicht:	15.6 kg
Bliester	2 St./Pack	Volumen:	0.0227 cbm
Verpackungseinheit	6 Packs/Box		
Umkarton	96 Packs/Karton		

Abmaße	
Bliester (mm)	84(B) x 114(H) x 27(T)
Verpackungseinheit (mm)	140(B) x 90(T) x 92(H)
Umkarton (cm)	37.5(B) x 29.5(T) x 20.5(H)



LR6-BP4

1.5V AA



Verpackung	4 St./Pack	Bruttogewicht:	15.5 kg
Bliester	4 St./Pack	Volumen:	0.0166 cbm
Verpackungseinheit	12 Packs/Box		
Umkarton	144 Packs/Karton		

Abmaße	
Bliester (mm)	84(B) x 114(H) x 15(T)
Verpackungseinheit (mm)	131(B) x 98(T) x 86(H)
Umkarton (cm)	27.5(B) x 28.0(T) x 22.5(H)



LR6-BP2

1.5V AA



Verpackung	2 St./Pack	Bruttogewicht:	12.6 kg
Bliester	2 St./Pack	Volumen:	0.0251 cbm
Verpackungseinheit	12 Packs/Box		
Umkarton	216 Packs/Karton		

Abmaße	
Bliester (mm)	84(B) x 114(H) x 15(T)
Verpackungseinheit (mm)	131(B) x 98(T) x 86(H)
Umkarton (cm)	41.5(B) x 27.5(T) x 22.0(H)



4 + 4LR6

1.5V AA



Verpackung	8 St./Pack	Bruttogewicht:	15.5 kg
Bliester	8 St./Pack	Volumen:	0.0199 cbm
Verpackungseinheit	12 packs/box		
Umkarton	72 Packs/Karton		

Abmaße	
Bliester (mm)	168(B) x 114(H) x 15(T)
Verpackungseinheit (mm)	175(B) x 140(T) x 10.8(H)
Umkarton (cm)	43.5(B) x 19.0(T) x 24.0(H)



LR6-HP12

1.5V AA



Verpackung	12 St./Pack	Bruttogewicht:	14.1 kg
Bliester	12 St./Pack	Volumen:	0.0098 cbm
Verpackungseinheit	48 Packs/Karton		
Umkarton	48 Packs/Karton		

Abmaße	
Verpackungseinheit (mm)	170(B) x 99(H) x 15(T)
Umkarton (cm)	35.5(B) x 22.0(T) x 12.5(H)



LR6-BP10

1.5V AA



Verpackung	10 St./Pack	Bruttogewicht:	18.8 kg
Bliester	10 St./Pack	Volumen:	0.0239 cbm
Verpackungseinheit	12 Packs/Box		
Umkarton	72 Packs/Karton		

Abmaße	
Bliester (mm)	84(B) x 190(H) x 15(T)
Verpackungseinheit (mm)	315(B) x 104(T) x 90(H)
Umkarton (cm)	33.0(B) x 31.5(T) x 23.0(H)



LR03-BP2

1.5V AAA



Verpackung	2 St./Pack	Bruttogewicht:	9.1 kg
Bliester	2 St./Pack	Volumen:	0.0237 cbm
Verpackungseinheit	12 Packs/Box		
Umkarton	288 Packs/Karton		

Abmaße	
Bliester (mm)	84(B) x 114(H) x 11(T)
Verpackungseinheit (mm)	119(B) x 75(T) x 86(H)
Umkarton (cm)	32.5(B) x 26.0(T) x 28.0(H)



LR03-BP4
1.5V AAA
 4 260033 150042

Verpackung		
Bliester	4 St./Pack	Bruttogewicht: 8,5 kg
Verpackungseinheit	12 Packs/Box	Volumen: 0,0119 cbm
Umkarton	144 Packs/Karton	

Abmaße

Bliester (mm)	84(B) x 114(H) x 11(T)
Verpackungseinheit (mm)	119(B) x 75(T) x 86(H)
Umkarton (cm)	27,5(B) x 25,5(T) x 17,0(H)



4 + 4LR03
1.5V AAA
 4 260216 451102

Verpackung		
Bliester	8 St./Pack	Bruttogewicht: 8,9 kg
Verpackungseinheit	12 Packs/Box	Volumen: 0,0150 cbm
Umkarton	72 Packs/Karton	

Abmaße

Bliester (mm)	168(B) x 1114(H) x 11(T)
Verpackungseinheit (mm)	175(B) x 130(T) x 85(H)
Umkarton (cm)	41,5(B) x 19,0(T) x 19,0(H)



LR03-BP10
1.5V AAA
 4 260033 150103

Verpackung		
Bliester	10 St./Pack	Bruttogewicht: 9,4 kg
Verpackungseinheit	12 Packs/Box	Volumen: 0,0152 cbm
Umkarton	72 Packs/Karton	

Abmaße

Bliester (mm)	84(B) x 165(H) x 11(T)
Verpackungseinheit (mm)	243(B) x 85(T) x 90(H)
Umkarton (cm)	30,0(B) x 26,0(T) x 19,5(H)



6LR61-BP1
9V
 4 260033 150066

Verpackung		
Bliester	1 St./Pack	Bruttogewicht: 11,2 kg
Verpackungseinheit	12 Packs/Box	Volumen: 0,0246 cbm
Umkarton	192 Packs/Karton	

Abmaße

Bliester (mm)	84(B) x 114(H) x 18(T)
Verpackungseinheit (mm)	123(B) x 117(T) x 86(H)
Umkarton (cm)	36,2(B) x 26,3(T) x 25,8(H)



LR1-BP2
1.5V N
 4 260033 150080

Verpackung		
Bliester	2 St./Pack	Bruttogewicht: 6,3 kg
Verpackungseinheit	6 Packs/Box	Volumen: 0,0181 cbm
Umkarton	192 Packs/Karton	

Abmaße

Bliester (mm)	84(B) x 114(H) x 12(T)
Verpackungseinheit (mm)	113(B) x 45(T) x 86(H)
Umkarton (cm)	36,2(B) x 25,0(T) x 20,0(H)



LR1-BP5
1.5V N
 4 260216 455780

Verpackung		
Bliester	5 pcs/pack	Bruttogewicht: 10,8 kg
Verpackungseinheit	12 packs/box	Volumen: 0,0150 cbm
Umkarton	192 packs/carton	

Abmaße

Bliester (mm)	50(W) x 160(H) x (D)
Verpackungseinheit (mm)	170(L) x 78(W) x 52(H)
Umkarton (cm)	33,5(L) x 19,0(W) x 23,5(H)



LR61-BP2
1.5V AAAA
 4 260033 150295

Verpackung		
Bliester	2 St./Pack	Bruttogewicht: 6,2 kg
Verpackungseinheit	12 Packs/Box	Volumen: 0,0251 cbm
Umkarton	288 Packs/Karton	

Abmaße

Bliester (mm)	84(B) x 114(H) x 11(T)
Verpackungseinheit (mm)	128(B) x 75(T) x 86(H)
Umkarton (cm)	32,5(B) x 27,6(T) x 28,0(H)



3LR12-BP1
4.5V
 4 260033 150073

Verpackung		
Bliester	1 St./Pack	Bruttogewicht: 16,9 kg
Verpackungseinheit	6 Packs/Box	Volumen: 0,0295 cbm
Umkarton	144 Packs/Karton	

Abmaße

Bliester (mm)	84(B) x 114(H) x 23(T)
Verpackungseinheit (mm)	160(B) x 75(T) x 86(H)
Umkarton (cm)	36,0(B) x 33,5(T) x 24,5(H)



LR6 bulk
1.5V AA

Verpackung		
Box	60 St./Pack	Bruttogewicht: 17,8 kg
Verpackungseinheit	720 Packs/Box	Volumen: 0,0096 cbm

Abmaße

Zelle (mm)	14(B) x 50(H) x 14(T)
Verpackungseinheit (mm)	174(B) x 72(T) x 50(H)
Umkarton (cm)	23,5(B) x 21,5(T) x 19,0(H)



LR03 bulk
1.5V AAA

Verpackung		
Shrink	60 St./Pack	Bruttogewicht: 14,7 kg
Verpackungseinheit	1200 Packs/Box	Volumen: 0,0084 cbm

Abmaße

Zelle (mm)	10(B) x 44,5(H) x 10(T)
Verpackungseinheit (mm)	83(B) x 52(T) x 45(H)
Umkarton (cm)	29,0(B) x 19,0(T) x 15,0(H)





LR6-SP40HFB
1.5V AA
 4 260216 456428

Verpackung
 Shrink 40 St./Pack
 Umkarton 12 Packs/Karton

Bruttogewicht:
 11.7 kg
 Volumen:
 0.0075 cbm

Abmaße
 Shrink (mm) 145(L) x 60(W) x 50(H)
 Umkarton (cm) 30.5(L) x 17.5(W) x 14.0(H)



LR03-SP40HFB
1.5V AAA
 4 260216 456435

Verpackung
 Shrink 40 St./Pack
 Umkarton 16 Packs/Karton

Bruttogewicht:
 10.8 kg
 Volumen:
 0.0051 cbm

Abmaße
 Shrink (mm) 106(L) x 44(W) x 46(H)
 Umkarton (cm) 23.0(L) x 20.0(W) x 11.0(H)



LR6-SP2
1.5V AA
 4 260033 150332

Verpackung
 Shrink 2 St./Pack
 Verpackungseinheit 20 Packs/Box
 Umkarton 360 Packs/Karton

Bruttogewicht:
 17.9 kg
 Volumen:
 0.0100 cbm

Abmaße
 Shrink (mm) 28(B) x 50(H) x 14(T)
 Verpackungseinheit (mm) 113(B) x 72(T) x 50(H)
 Umkarton (cm) 31.5(B) x 23.5(T) x 13.5(H)



LR6-SP4
1.5V AA
 4 260033 150325

Verpackung
 Shrink 4 St./Pack
 Verpackungseinheit 15 Packs/Box
 Umkarton 180 Packs/Karton

Bruttogewicht:
 17.8 kg
 Volumen:
 0.0096 cbm

Abmaße
 Shrink (mm) 56(B) x 50(H) x 14(T)
 Verpackungseinheit (mm) 174(B) x 72(T) x 50(H)
 Umkarton (cm) 23.5(B) x 21.5(T) x 19.0(H)



LR03-SP2
1.5V AAA
 4 260033 150356

Verpackung
 Shrink 2 St./Pack
 Verpackungseinheit 20 Packs/Box
 Umkarton 600 Packs/Karton

Bruttogewicht:
 14.8kg
 Volumen:
 0.0083cbm

Abmaße
 Shrink (mm) 20(B) x 44.5(H) x 10(T)
 Verpackungseinheit (mm) 83(B) x 52(T) x 45(H)
 Umkarton (cm) 29.0(B) x 19.0(T) x 15.0(H)



LR03-SP4
1.5V AAA
 4 260033 150349

Verpackung
 Shrink 4 St./Pack
 Verpackungseinheit 15 Packs/Box
 Umkarton 300 Packs/Karton

Bruttogewicht:
 14.7kg
 Volumen:
 0.0084cbm

Abmaße
 Shrink (mm) 40(B) x 44.5(H) x 10(T)
 Verpackungseinheit (mm) 125(B) x 52(T) x 45(H)
 Umkarton (cm) 29.0(B) x 20.0(T) x 14.5(H)



LR14-SP2
1.5V C
 4 260033 150318

Verpackung
 Shrink 2 St./Pack
 Verpackungseinheit 6 Packs/Box
 Umkarton 120 Packs/Karton

Bruttogewicht:
 16.6 kg
 Volumen:
 0.0123 cbm

Abmaße
 Shrink (mm) 52(B) x 50(H) x 26(T)
 Verpackungseinheit (mm) 107(B) x 81(T) x 56(H)
 Umkarton (cm) 29.5(B) x 22.5(T) x 18.5(H)



LR20-SP2
1.5V D
 4 260033 150301

Verpackung
 Shrink 2 St./Pack
 Verpackungseinheit 6 Packs/Box
 Umkarton 60 Packs/Karton

Bruttogewicht:
 16.7 kg
 Volumen:
 0.0122 cbm

Abmaße
 Shrink (mm) 66(B) x 61(H) x 33(T)
 Verpackungseinheit (mm) 134(B) x 100(T) x 62(H)
 Umkarton (cm) 33.0(B) x 15.5(T) x 22.0(H)



6LR61-SP1
9V
 4 260033 150363

Verpackung
 Shrink 1 St./Pack
 Verpackungseinheit 12 Packs/Box
 Umkarton 240 Packs/Karton

Bruttogewicht:
 11.4 kg
 Volumen:
 0.0083 cbm

Abmaße
 Shrink (mm) 25.5(B) x 48.5(H) x 17.5(T)
 Verpackungseinheit (mm) 105(B) x 52(T) x 50(H)
 Umkarton (cm) 29.0(B) x 23.0(T) x 12.5(H)



3LR12-SP1
4.5V
 4 260033 150370

Verpackung
 Shrink 1 St./Pack
 Verpackungseinheit 12 Packs/Box
 Umkarton 192 Packs/Karton

Bruttogewicht:
 16.6 kg
 Volumen:
 0.0233 cbm

Abmaße
 Shrink (mm) 62(B) x 65.5(H) x 22(T)
 Verpackungseinheit (mm) 188(B) x 90(T) x 65(H)
 Umkarton (cm) 38.5(B) x 20.5(T) x 29.5(H)



LR6-PB24

1.5V AA



Verpackung 24 St./Pack
 Box 30 Packs/Karton
 Umkarton 30 Packs/Karton
Bruttogewicht: 17.5 kg
Volumen: 0.0178 cbm

Abmaße
 Box (mm) 97(B) x 72(T) x 50(H)
 Umkarton (cm) 42.5(B) x 22.0(T) x 19.0(H)



LR03-PB24

1.5V AAA



Verpackung 24 St./Pack
 Box 30 Packs/Karton
 Umkarton 30 Packs/Karton
Bruttogewicht: 9.0 kg
Volumen: 0.0107 cbm

Abmaße
 Box (mm) 80(B) x 60(T) x 45(H)
 Umkarton (cm) 34.5(B) x 18.5(T) x 17.0(H)



LR6-PB20

1.5V AA



Verpackung 20 St./Pack
 Box 6 Packs/Box
 Verpackungseinheit 24 Packs/Karton
 Umkarton 24 Packs/Karton
Bruttogewicht: 14.1 kg
Volumen: 0.0144 cbm

Abmaße
 Box (mm) 98(B) x 75(H) x 50(T)
 Verpackungseinheit (mm) 237(B) x 200(T) x 65(H)
 Umkarton (cm) 25.0(B) x 21.7(T) x 26.5(H)



LR03-PB20

1.5V AAA



Verpackung 20 St./Pack
 Box 6 Packs/Box
 Verpackungseinheit 24 Packs/Karton
 Umkarton 24 Packs/Karton
Bruttogewicht: 7.4 kg
Volumen: 0.009 cbm

Abmaße
 Box (mm) 76(B) x 60(H) x 44(T)
 Verpackungseinheit (mm) 190(B) x 165(T) x 60(H)
 Umkarton (cm) 20.5(B) x 17.5(T) x 25.0(H)



6LR61-PB6

9V



Verpackung 6 St./Pack
 Box 6 Packs/Box
 Verpackungseinheit 24 Packs/Karton
 Umkarton 24 Packs/Karton
Bruttogewicht: 7.8 kg
Volumen: 0.0105 cbm

Abmaße
 Box (mm) 71(B) x 68(H) x 49(T)
 Verpackungseinheit (mm) 210(B) x 148(T) x 60(H)
 Umkarton (cm) 31.0(B) x 22.5(T) x 15.0(H)



LR03-PBH24

1.5V AAA



Verpackung 24 St./Pack
 Box 12 Packs/Box
 Verpackungseinheit 24 boxen/Karton
 Umkarton 24 boxen/Karton
Bruttogewicht: 8.8 kg
Volumen: 0.0084 cbm

Abmaße
 Box (mm) 96(B) x 70(H) x 26(T)
 Verpackungseinheit (mm) 220(B) x 200(T) x 65(H)
 Umkarton (cm) 24.0(B) x 22.0(T) x 16.0(H)



LR6-PBH24

1.5V AA



Verpackung 24 St./Pack
 Box 12 Packs/Box
 Verpackungseinheit 24 boxen/Karton
 Umkarton 24 boxen/Karton
Bruttogewicht: 16.3 kg
Volumen: 0.0142 cbm

Abmaße
 Box (mm) 108(B) x 92(H) x 32(T)
 Verpackungseinheit (mm) 285(B) x 225(T) x 80(H)
 Umkarton (cm) 30.5(B) x 24.5(T) x 19.0(H)



CM-FA-01



Verpackung 10xLR6+8xLR03+
 2x6LF22+4xC Typ Adapter+
 4xD Typ Adapter+BT-0503
 Umkarton 10 Boxen/Karton
Bruttogewicht: 15.2 kg
Volumen: 0.0206 cbm

Abmaße
 Box (mm) 255(B) x 173(T) x 37(H)
 Umkarton (cm) 35.8(B) x 26.7(T) x 21.5(H)

Schrumpffolienverpackung und Display Boxen

Praktische Verpackung

Unsere Schrumpffolienverpackung und Display Boxen helfen Ihre Batterien mit minimalem Aufwand zu präsentieren.

- Leicht tragbar und langlebig
- verkaufsfördernde Display Box
- In vielen Größen und Formen erhältlich
- übersichtlich geordnet über zwei Lagen in der Display Box
- inklusive professionell gestaltete Einlegekarten für wirksame Werbung



LR6-SP10-DA

1.5V AA



4 260033 157249

Verpackung

Shrink 10 St./Pack
Verpackungseinheit 24 Packs/Box
Umkarton 2 boxen/Karton

Bruttogewicht:
12.3 kg
Volumen:
0.0087 cbm

Abmaße

Box (mm) 190(B) x 150(H) x 108(T)
Umkarton (cm) 31.5(B) x 20.5(T) x 13.5(H)



LR03-SP10-DA

1.5V AAA



4 260033 157256

Verpackung

Shrink 10 St./Pack
Verpackungseinheit 20 Packs/Box
Umkarton 4 boxen/Karton

Bruttogewicht:
9.9 kg
Volumen:
0.0075 cbm

Abmaße

Box (mm) 110(B) x 120(H) x 96(T)
Umkarton (cm) 25.5(B) x 23.5(T) x 12.5(H)



LR6-SP10+2-DA

1.5V AA



4 260216 455643

Verpackung

Shrink 12 St./Pack
Verpackungseinheit 20 Packs/Box
Umkarton 2 boxen/Karton

Bruttogewicht:
11.8 kg
Volumen:
0.0079 cbm

Abmaße

Box (mm) 175(B) x 150(H) x 110(T)
Umkarton (cm) 31.5(B) x 19.0(T) x 13.2(H)



LR03-SP10+2-DA

1.5V AAA



4 260216 455650

Verpackung

Shrink 12 St./Pack
Verpackungseinheit 20 Packs/Box
Umkarton 4 boxen/Karton

Bruttogewicht:
11.8 kg
Volumen:
0.0075 cbm

Abmaße

Box (mm) 130(B) x 110(H) x 100(T)
Umkarton (cm) 23.5(B) x 14.5(T) x 22.0(H)

Limited Edition

Vorteilspackungen für limitierte Aktionen



8+4LR6-BP
1.5V AA



Verpackung	Blister 12 St./Pack	Bruttogewicht: 15 kg
	Verpackungseinheit 6 Packs/Box	Volumen: 0.0190 cbm
	Umkarton 48 Packs/Karton	

Abmaße		
Blister (mm)	125(B) x 114(H) x 29(T)	
Verpackungseinheit (mm)	132(B) x 100(T) x 137(H)	
Umkarton (cm)	29.5(B) x 28.5(T) x 22.5(H)	



8+4LR03-BP
1.5V AAA



Verpackung	Blister 12 St./Pack	Bruttogewicht: 12.2 kg
	Verpackungseinheit 6 Packs/Box	Volumen: 0.0207 cbm
	Umkarton 72 Packs/Karton	

Abmaße		
Blister (mm)	125(B) x 114(H) x 21(T)	
Verpackungseinheit (mm)	132(B) x 75(T) x 125(H)	
Umkarton (cm)	41.5(B) x 28.5(T) x 17.5(H)	

DR-16 (8+4)

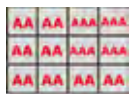

DR16 Promotion Display "8+4 free"

- Plus Alkaline Bodendisplay für Promotion Blister "8+4 free" (AA / AAA)
- Höhe (gesamt) 1,17m + Palette
- Breite 0,55m
- Tiefe 0,38m
- Material Pappe
- Oberfläche glänzend
- 12x Gitter = 12 Ablagefächer
- 48x LR6 "8+4 free" (8 Ablagefächer)
6 Blister per Ablagefach
- 36 x LR03 "8+4 free" (4 Ablagefächer)
9 Blister per Ablagefach
- 84 Blister gesamt



Super Heavy Duty Batterien

Camelion Super Heavy Duty / Zink-Kohle Batterien liefern ökonomischen Strom für eine große Palette von Geräten wie Taschenlampen, Radios und Fernbedienungen. Ein einzigartiger Aufbau ist extra entworfen worden, um den Auslaufschutz, lange Lagerfähigkeit und lange Lebensdauer zu gewährleisten. Die CAMELION Zink-Kohle Batterien sind cadmium- und quecksilberfrei und schonen damit die Umwelt.



R20P-BP2B 

1.5V D 4 260033 151018

Verpackung		
Blister	2 St./Pack	Bruttogewicht:
Verpackungseinheit	6 Packs/Box	14.9 kg
Umkarton	72 Packs/Karton	Volumen:
		0.0238 cbm

Abmaße

Blister (mm)	84(B) x 114(H) x 34(T)
Verpackungseinheit (mm)	160(B) x 110(T) x 92(H)
Umkarton (cm)	33.5(B) x 19.5(T) x 24.5(H)



R14P-BP2B 

1.5V C 4 260033 151025

Verpackung		
Blister	2 St./Pack	Bruttogewicht:
Verpackungseinheit	6 Packs/Box	15.6 kg
Umkarton	144 Packs/Karton	Volumen:
		0.0315 cbm

Abmaße

Blister (mm)	84(B) x 114(H) x 27(T)
Verpackungseinheit (mm)	137(B) x 86(T) x 86(H)
Umkarton (cm)	37.5(B) x 29.5(T) x 28.5(H)



R6P-BP4B 

1.5V AA 4 260033 151049

Verpackung		
Blister	4 St./Pack	Bruttogewicht:
Verpackungseinheit	12 Packs/Box	17.5 kg
Umkarton	240 Packs/Karton	Volumen:
		0.0272 cbm

Abmaße

Blister (mm)	84(B) x 114(H) x 15(T)
Verpackungseinheit (mm)	131(B) x 98(T) x 86(H)
Umkarton (cm)	45.0(B) x 27.5(T) x 22.0(H)



R03P-BP4B 

1.5V AAA 4 260033 151070

Verpackung		
Blister	4 St./Pack	Bruttogewicht:
Verpackungseinheit	12 Packs/Box	12.0 kg
Umkarton	288 Packs/Karton	Volumen:
		0.0237 cbm

Abmaße

Blister (mm)	84(B) x 114(H) x 11(T)
Verpackungseinheit (mm)	119(B) x 75(T) x 86(H)
Umkarton (cm)	32.5(B) x 26.0(T) x 28.0(H)



R6P-HP12B 

4.5V 4 260033 151438

Verpackung		
Blister	12 pcs/pack	Bruttogewicht:
Umkarton	48 packs/Karton	9.3 kg
		Volumen:
		0.0098cbm

Dimensions

Blister (mm)	170(B) x 100(H) x 15(T)
Umkarton (cm)	23.5(B) x 25.5(T) x 20.5(H)



6F22-BP1B 

9V 4 260033 151094

Verpackung		
Blister	1 St./Pack	Bruttogewicht:
Verpackungseinheit	12 Packs/Box	11.4 kg
Umkarton	240 Packs/Karton	Volumen:
		0.0310 cbm

Abmaße

Blister (mm)	84(B) x 114(H) x 18(T)
Verpackungseinheit (mm)	123(B) x 117(T) x 86(H)
Umkarton (cm)	45.0(B) x 27.0(T) x 25.5(H)



4R25-SP1B 

6V 4 260033 153531

Verpackung		
Shrink	1 St./Pack	Bruttogewicht:
Verpackungseinheit	6 Packs/Box	6.7 kg
Umkarton	12 Packs/Karton	Volumen:
		0.0090 cbm

Abmaße

Shrink (mm)	68.2(B) x 68.2(H) x 115 (T)
Verpackungseinheit (mm)	205(B) x 135(T) x 120(H)
Umkarton (cm)	29.0(B) x 22.0(T) x 14.0(H)



R20P-BP2G
1.5V D
 4 260033 156280

Verpackung
 Blister 2 St./Pack
 Verpackungseinheit 6 Packs/Box
 Umkarton 72 Packs/Karton

Bruttogewicht: 14.3 kg
 Volumen: 0.0238 cbm

Abmaße
 Blister (mm) 84(B) x 114(H) x 34(T)
 Verpackungseinheit (mm) 160(B) x 110(T) x 92(H)
 Umkarton (cm) 33.5(B) x 19.5(T) x 24.5(H)



R20P-BP4G
1.5V D
 4 260033 156358

Verpackung
 Blister 4 St./Pack
 Verpackungseinheit 6 Packs/Box
 Umkarton 54 Packs/Karton

Bruttogewicht: 21.9 kg
 Volumen: 0.0340 cbm

Abmaße
 Blister (mm) 84(B) x 190(H) x 34(T)
 Verpackungseinheit (mm) 290(B) x 110(T) x 90(H)
 Umkarton (cm) 31.0(B) x 30.5(T) x 36.0(H)



R14P-BP2G
1.5V C
 4 260033 156297

Verpackung
 Blister 2 St./Pack
 Verpackungseinheit 6 Packs/Box
 Umkarton 144 Packs/Karton

Bruttogewicht: 14.9 kg
 Volumen: 0.0315 cbm

Abmaße
 Blister (mm) 84(B) x 114(H) x 27(T)
 Verpackungseinheit (mm) 137(B) x 86(T) x 86(H)
 Umkarton (cm) 37.5(B) x 29.5(T) x 28.5(H)



R14P-BP4G
1.5V C
 4 260033 156389

Verpackung
 Blister 4 St./Pack
 Verpackungseinheit 6 packs/box
 Umkarton 54 Packs/Karton

Bruttogewicht: 10.4 kg
 Volumen: 0.0245cbm

Abmaße
 Blister (mm) 84(B) x 165(H) x 27(T)
 Verpackungseinheit (mm) 240(B) x 90(T) x 90(H)
 Umkarton (cm) 32.0(B) x 25.5(T) x 30.0(H)



R14P-BP6G
1.5V C
 4 260033 150936

Verpackung
 Blister 4 St./Pack
 Verpackungseinheit 4 Packs/Box
 Umkarton 48 Packs/Karton

Bruttogewicht: 15 kg
 Volumen: 0.0336 cbm

Abmaße
 Blister (mm) 84(B) x 210(H) x 27(T)
 Verpackungseinheit (mm) 220(B) x 110(T) x 90(H)
 Umkarton (cm) 46.5(B) x 24.5(T) x 29.5(H)



R6P-BP8G
1.5V AA
 4 260033 156402

Verpackung
 Blister 8 St./Pack
 Verpackungseinheit 12 Packs/Box
 Umkarton 72 Packs/Karton

Bruttogewicht: 11.8 kg
 Volumen: 0.0198 cbm

Abmaße
 Blister (mm) 84(B) x 165(H) x 15(T)
 Verpackungseinheit (mm) 265(B) x 100(T) x 90(H)
 Umkarton (cm) 31.5(B) x 28.0(T) x 22.5(H)



R6P-BP4G
1.5V AA
 4 260033 156303

Verpackung
 Blister 4 St./Pack
 Verpackungseinheit 12 Packs/Box
 Umkarton 240 Packs/Karton

Bruttogewicht: 16.3 kg
 Volumen: 0.0272 cbm

Abmaße
 Blister (mm) 84(B) x 114(H) x 15(T)
 Verpackungseinheit (mm) 131(B) x 98(T) x 86(H)
 Umkarton (cm) 45.0(B) x 27.5(T) x 22.0(H)

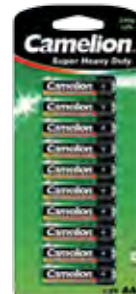

R6P-BP10G
1.5V AA
 4 260033 156396

Verpackung
 Blister 10 St./Pack
 Verpackungseinheit 12 Packs/Box
 Umkarton 72 Packs/Karton

Bruttogewicht: 14.6 kg
 Volumen: 0.0239 cbm

Abmaße
 Blister (mm) 84(B) x 190(H) x 15(T)
 Verpackungseinheit (mm) 315(B) x 104(T) x 90(H)
 Umkarton (cm) 33.0(B) x 31.5(T) x 23.0(H)



R03P-BP4G
1.5V AAA
 4 260033 156327

Verpackung
 Blister 4 St./Pack
 Verpackungseinheit 12 Packs/Box
 Umkarton 288 Packs/Karton

Bruttogewicht: 12.0 kg
 Volumen: 0.0237 cbm

Abmaße
 Blister (mm) 84(B) x 114(H) x 11(T)
 Verpackungseinheit (mm) 119(B) x 75(T) x 86(H)
 Umkarton (cm) 32.5(B) x 26.0(T) x 28.0(H)



R03P-BP8G
1.5V AAA
 4 260033 156426

Verpackung
 Blister 8 St./Pack
 Verpackungseinheit 12 Packs/Box
 Umkarton 72 Packs/Karton

Bruttogewicht: 7.9 kg
 Volumen: 0.0132 cbm

Abmaße
 Blister (mm) 84(B) x 165(H) x 15(T)
 Verpackungseinheit (mm) 200(B) x 84(T) x 90(H)
 Umkarton (cm) 30.0(B) x 22.0(T) x 20.0(H)



6F22-BP1G
9V
 4 260033 156341
 Verpackung 1 St./Pack
 Blister 12 packs/box
 Verpackungseinheit 240 Packs/Karton
Bruttogewicht: 11.4 kg
Volumen: 0.0310 cbm
Abmaße
 Blister (mm) 84(B) x 114(H) x 18(T)
 Verpackungseinheit (mm) 123(B) x 117(T) x 86(H)
 Umkarton (cm) 45.0(B) x 27.0(T) x 25.5(H)



6F22-BP2G
9V
 4 260033 156365
 Verpackung 2 St./Pack
 Blister 12 packs/box
 Verpackungseinheit 192 Packs/Karton
Bruttogewicht: 18.3 kg
Volumen: 0.0310 cbm
Abmaße
 Blister (mm) 84(B) x 114(H) x 18(T)
 Verpackungseinheit (mm) 123(B) x 117(T) x 86(H)
 Umkarton (cm) 45.0(B) x 27.0(T) x 25.5(H)



3R12-BP1G
4.5V
 4 260033 156372
 Verpackung 1 St./Pack
 Blister 6 Packs/Box
 Verpackungseinheit 144 Packs/Karton
Bruttogewicht: 15.4 kg
Volumen: 0.0290 cbm
Abmaße
 Blister (mm) 84(B) x 114(H) x 23(T)
 Verpackungseinheit (mm) 160(B) x 75(T) x 86(H)
 Umkarton (cm) 33.5(B) x 31.5(T) x 27.5(H)



2R10-BP1G
3V
 4 260033 150943
 Verpackung 1 St./Pack
 Blister 12 Packs/Box
 Verpackungseinheit 240 Packs/Karton
Bruttogewicht: 11.0 kg
Volumen: 0.0533 cbm
Abmaße
 Blister (mm) 84(B) x 124(H) x 14(T)
 Verpackungseinheit (mm) 156(B) x 115(T) x 125(H)
 Umkarton (cm) 59.5(B) x 28.0(T) x 32.0(H)



R20P-SP2G
1.5V D
 4 260033 156433
 Verpackung 2 St./Pack
 Shrink 6 Packs/Box
 Verpackungseinheit 96 Packs/Karton
Bruttogewicht: 17.5 kg
Volumen: 0.0169 cbm
Abmaße
 Shrink (mm) 66(B) x 61(H) x 33(T)
 Verpackungseinheit (mm) 137(B) x 103(T) x 68(H)
 Umkarton (cm) 28.5(B) x 22.0(T) x 27.0(H)



R14P-SP2G
1.5V C
 4 260033 156440
 Verpackung 2 St./Pack
 Shrink 6 packs/box
 Verpackungseinheit 144 Packs/Karton
Bruttogewicht: 13.2 kg
Volumen: 0.0129 cbm
Abmaße
 Shrink (mm) 52(B) x 50(H) x 26(T)
 Verpackungseinheit (mm) 104(B) x 78(T) x 50(H)
 Umkarton (cm) 25.5(B) x 23.0(T) x 22.0(H)



R6P-SP2G
1.5V AA
 4 260033 156464
 Verpackung 2 St./Pack
 Shrink 30 packs/box
 Verpackungseinheit 480 Packs/Karton
Bruttogewicht: 15.5 kg
Volumen: 0.0127cbm
Abmaße
 Shrink (mm) 28(B) x 50(H) x 14(T)
 Verpackungseinheit (mm) 113(B) x 72(T) x 50(H)
 Umkarton (cm) 30.5(B) x 22.0(T) x 19.0(H)



R6P-SP4G
1.5V AA
 4 260033 156457
 Verpackung 4 St./Pack
 Shrink 15 Packs/Box
 Verpackungseinheit 240 Packs/Karton
Bruttogewicht: 18.0 kg
Volumen: 0.0127 cbm
Abmaße
 Shrink (mm) 56(B) x 50(H) x 14(T)
 Verpackungseinheit (mm) 174(B) x 72(T) x 50(H)
 Umkarton (cm) 30.5(B) x 22.0(T) x 19.0(H)



R03P-SP2G
1.5V AAA
 4 260033 156488
 Verpackung 2 St./Pack
 Shrink 30 Packs/Box
 Verpackungseinheit 600 Packs/Karton
Bruttogewicht: 9.5 kg
Volumen: 0.0083 cbm
Abmaße
 Shrink (mm) 40(B) x 44.5(H) x 10(T)
 Verpackungseinheit (mm) 83(B) x 52(T) x 45(H)
 Umkarton (cm) 28.5(B) x 20.0(T) x 14.5(H)



R03P-SP4G
1.5V AAA
 4 260033 156471
 Verpackung 4 St./Pack
 Shrink 15 Packs/Box
 Verpackungseinheit 300 Packs/Karton
Bruttogewicht: 9.85kg
Volumen: 0.0083cbm
Abmaße
 Shrink (mm) 40(B) x 44.5(H) x 10(T)
 Verpackungseinheit (mm) 125(B) x 52(T) x 45(H)
 Umkarton (cm) 28.5(B) x 20.0(T) x 14.5(H)

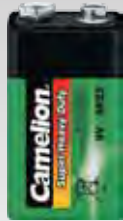

6F22-SP1G

9V



Verpackung 1 St./Pack
Shrink 12 Packs/Box
Verpackungseinheit 480 Packs/Karton
Bruttogewicht: 19.0 kg
Volumen: 0.0144 cbm

Abmaße
Shrink (mm) 25.5(B) x 48.5(H) x 17.5(T)
Verpackungseinheit (mm) 105(B) x 52(T) x 50(H)
Umkarton (cm) 29.0(B) x 22.5(T) x 22.0(H)



4R25-SP1G

6V



Verpackung 1 St./Pack
Shrink 6 Packs/Box
Verpackungseinheit 12 Packs/Karton
Bruttogewicht: 6.7 kg
Volumen: 0.0090 cbm

Abmaße
Shrink (mm) 68.5(B) x 68.5(H) x 115 (T)
Verpackungseinheit (mm) 205(B) x 135(T) x 120(H)
Umkarton (cm) 29.0(B) x 22.0(T) x 14.0(H)



3R12-SP1G

4.5V



Verpackung 1 St./Pack
Shrink 12 Packs/Box
Verpackungseinheit 144 Packs/Karton
Bruttogewicht: 16.6 kg
Volumen: 0.0188 cbm

Abmaße
Shrink (mm) 62(B) x 65.5(H) x 22(T)
Verpackungseinheit (mm) 188(B) x 90(T) x 65(H)
Umkarton (cm) 39.0(B) x 21.0(T) x 23.0(H)



FPG-GB40



Verpackung 4x R14P + 24 x R6P + 12 x R03P + 1 x SL3013(Blue 3LR44)
Umkarton 18 boxes/carton
Bruttogewicht: 13.0 kg
Volumen: 0.0223cbm

Abmaße
Box (mm) 132(B) x 126(T) x 54(H)
Umkarton (cm) 40.0(B) x 28.0(T) x 19.5(H)



4+2R6PG-BP

1.5V AA



Verpackung 6 pcs/pack
Shrink 12 packs/box
Verpackungseinheit 72 packs/carton
Bruttogewicht: 7.5 kg
Volumen: 0.0160 cbm

Abmaße
Shrink (mm) 125(W) x 114(H) x 15(D)
Verpackungseinheit (mm) 132(L) x 105(W) x 138(H)
Umkarton (cm) 41.5(L) x 29.5(W) x 13.5(H)



4+2R03PG-BP

1.5V AAA



Verpackung 6 pcs/pack
Shrink 12 packs/box
Verpackungseinheit 144 packs/carton
Bruttogewicht: 9.2 kg
Volumen: 0.0207 cbm

Abmaße
Shrink (mm) 125(W) x 114(H) x 11(D)
Verpackungseinheit (mm) 132(L) x 755(W) x 125(H)
Umkarton (cm) 41.5(L) x 28.5(W) x 17.5(H)



R6P-SP8G

1.5V AA



Verpackung 8 St./Pack
Shrink 20 Packs/Box
Verpackungseinheit 6 Boxen/Karton
Bruttogewicht: 14.7 kg
Volumen: 0.0147 cbm

Abmaße
Box (mm) 150(B) x 118(H) x 110(T)
Umkarton (cm) 34.5(B) x 25.0(T) x 17.0(H)



R03P-SP8G

1.5V AAA



Verpackung 8 St./Pack
Shrink 40 Packs/Box
Verpackungseinheit 6 Boxen/Karton
Bruttogewicht: 15.3 kg
Volumen: 0.0141 cbm

Abmaße
Box (mm) 170(B) x 110(H) x 100(T)
Umkarton (cm) 31.5(B) x 23.5(T) x 19.0(H)



R6P-SP12G

1.5V AA



Verpackung 12 St./Pack
Shrink 6 Packs/Box
Verpackungseinheit 80 Boxen/Karton
Bruttogewicht: 16.5 kg
Volumen: 0.0127 cbm

Abmaße
Box (mm) 175(B) x 150(H) x 110(T)
Umkarton (cm) 31.5(B) x 19.0(T) x 24.0(H)



R03P-SP12G

1.5V AAA



Verpackung 12 St./Pack
Shrink 20 Packs/Box
Verpackungseinheit 8 Boxen/Karton
Bruttogewicht: 14.8 kg
Volumen: 0.0143 cbm

Abmaße
Box (mm) 130(L) x 110(W) x 100(H)
Umkarton (cm) 27.5(L) x 23.5(W) x 22.0(H)





Foto Batterien

Camelion Foto Batterien sind für die Anwendungen von vielen Kameras geeignet.



CR123A-BP1

3V



Verpackung

Blister 1 St./Pack
Verpackungseinheit 10 Packs/Box
Umkarton 200 Packs/Karton

Bruttogewicht: 5.5 kg
Volumen: 0.0243 cbm

Abmaße

Blister (mm) 84(B) x 114(H) x 17.5(T)
Verpackungseinheit (mm) 118(B) x 95(T) x 85(H)
Umkarton (cm) 45.0(B) x 25.0(T) x 21.5(H)



CR123A-BP2

3V



Verpackung

Blister 2 St./Pack
Verpackungseinheit 10 Packs/Box
Umkarton 100 Packs/Karton

Bruttogewicht: 8.6 kg
Volumen: 0.0242 cbm

Abmaße

Blister (mm) 84(B) x 114(H) x 18(T)
Verpackungseinheit (mm) 118(B) x 95(T) x 85(H)
Umkarton (cm) 45.0(B) x 25.0(T) x 21.5(H)



CR-P2-BP1

6V



Verpackung

Blister 1 St./Pack
Verpackungseinheit 10 Packs/Box
Umkarton 200 Packs/Karton

Bruttogewicht: 10.0 kg
Volumen: 0.0265 cbm

Abmaße

Blister (mm) 84(B) x 114(H) x 20.5(T)
Verpackungseinheit (mm) 118(B) x 105(T) x 85(H)
Umkarton (cm) 45.0(B) x 25.0(T) x 23.5(H)



2CR5-BP1

6V



Verpackung

Blister 1 St./Pack
Verpackungseinheit 10 Packs/Box
Umkarton 200 Packs/Karton

Bruttogewicht: 10.0 kg
Volumen: 0.0265 cbm

Abmaße

Blister (mm) 84(B) x 114(H) x 18(T)
Verpackungseinheit (mm) 118(B) x 105(T) x 85(H)
Umkarton (cm) 45.0(B) x 25.0(T) x 23.5(H)



CR2-BP1

3V



Verpackung

Blister 1 St./Pack
Verpackungseinheit 10 Packs/Box
Umkarton 200 Packs/Karton

Bruttogewicht: 4.5 kg
Volumen: 0.0215 cbm

Abmaße

Blister (mm) 84(B) x 114(H) x 16.5(T)
Verpackungseinheit (mm) 118(B) x 85(T) x 85(H)
Umkarton (cm) 45.0(B) x 25.0(T) x 19.0(H)

Knopfzellen

Camelion Knopfzellen liefern zuverlässigen Strom für kleine elektronische Geräte und sind als Lithium, Alkaline, Silber-Oxyd und Zink-Luft Knopfzelle erhältlich. Ideal für Autoschlüssel, Taschenrechner, Laserpointer, Hörgeräte und viele andere elektronische Kleingeräte.



Lithium Knopfzellen 3V



Artikel	EAN	Verpackung (B x H x T)(mm)	Verpackungseinheit (B x T x H) (mm)	Umkarton (B x T x H) (mm)	Gewicht (KG)	Volumen(CBM)
CR1216-BP1	4260033152831	56 x 92 x 3 1 PC / BLISTER	98 x 37 x 58 10 PACKS	45.5 x 31.5 x 31.5 1800 PACKS	9.5	0.0451
CR1220-BP1	4260033152824				8.0	
CR1225-BP1	4260033152817				8.0	
CR1616-BP1	4260033152800				8.0	
CR1620-BP1	4260033152794				8.5	
CR1632-BP1	4260033152923				10.4	
CR2016-BP1	4260033152787				9.5	
CR2025-BP1	4260033152770				11.0	
CR2032-BP1	4260033152763				12.0	
CR2320-BP1	4260033152756				11.5	
CR2325-BP1	4260033152848				12.0	
CR2330-BP1	4260033152749				13.0	
CR2430-BP1	4260033152732				13.5	
CR2450-BP1	4260033152725				17.5	
CR2477-BP1	4260216455353				17.72	
CR927-BP1	4260216452475				14.0	
CR1216-BP5	4260033152718	55x 190 x 3 5 PCS / BLISTER	195 x 90 x 58 30 PACKS	29.0 x 22.0 x 26.0 360 PACKS	4.5	0.0165
CR1220-BP5	4260033152701				4.5	
CR1225-BP5	4260033152695				5.0	
CR1616-BP5	4260033152688				5.5	
CR1620-BP5	4260033152671				5.5	
CR1632-BP5	4260216455797				6.5	
CR2016-BP5	4260033152664				8.0	
CR2025-BP5	4260033152657				9.0	
CR2032-BP5	4260033152640				5.5	
CR2430-BP5	4260216455803				12.2	
CR2450-BP5	4260216455810	16.7				
CRVP01-BP6	4260216456145	125x114x6.5 6 PCS / BLISTER	138 x 85 x 127 24 PACKS	29.5 x 27.5 x 28.0 288 PACKS	8.0	0.0227



Alkaline Knopfzellen 1.5V

0% Hg



Artikel (0%Hg)	EAN	Verpackung (B x H x T)(mm)	Verpackungseinheit (B x T x H)(mm)	Umkarton (B x T x H)(mm)	Gewicht (KG)	Volumen (CBM)
AG1-BP2(0%Hg)	4260216454783	56 x 92 x 5 2 PC / BLISTER	95 x 63 x 58 20 PACKS	39.5 x 30.5 x 31.5 1800 PACKS	7.0	0.0379
AG2-BP2(0%Hg)	4260216454790				7.8	
AG3-BP2(0%Hg)	4260216454806				8.0	
AG4-BP2(0%Hg)	4260216454622				7.0	
AG5-BP2(0%Hg)	4260216454813	56 x 92 x 7 2 PC / BLISTER	98 x 73 x 58 20 PACKS	45.5 x 31.5 x 31.5 1800 PACKS	9.0	0.0451
AG6-BP2(0%Hg)	4260216454820	56 x 92 x 5 2 PC / BLISTER	95 x 63 x 58 20 PACKS	39.5 x 30.5 x 31.5 1800 PACKS	8.0	0.0379
AG7-BP2(0%Hg)	4260216454837				8.5	
AG8-BP2(0%Hg)	4260216454844				9.0	
AG9-BP2(0%Hg)	4260216454851				9.0	
AG10-BP2(0%Hg)	4260216454608				10.0	
AG11-BP2(0%Hg)	4260216454868				7.0	
AG12-BP2(0%Hg)	4260216454875	56 x 92 x 7 2 PC / BLISTER	98 x 73 x 58 20 PACKS	45.5 x 31.5 x 31.5 1800 PACKS	11.0	0.0451
AG13-BP2(0%Hg)	4260216454615				13.0	
625A-BP1(0%Hg)	4260216454882	56 x 92 x 7 1 PC / BLISTER	146 x 98 x 58 40 PACKS	45.5 x 31.5 x 31.5 1800 PACKS	18.0	0.0451
AG0-BP10(0%Hg)	4260216454899	50x 160 x 5 10 PCS / BLISTER	170 x 40 x 52 20 PACKS	50.0 x 20.0 x 20.0 360 PACKS	4.0	0.0198
AG1-BP10(0%Hg)	4260216454905				4.0	
AG2-BP10(0%Hg)	4260216454912				4.5	
AG3-BP10(0%Hg)	4260216454929				5.0	
AG4-BP10(0%Hg)	4260216454400				4.0	
AG5-BP10(0%Hg)	4260216454936				6.5	
AG6-BP10(0%Hg)	4260216454943				5.0	
AG7-BP10(0%Hg)	4260216454950				5.5	
AG8-BP10(0%Hg)	4260216454967				6.0	
AG9-BP10(0%Hg)	4260216454974				6.0	
AG10-BP10(0%Hg)	4260216454981				7.0	
AG11-BP10(0%Hg)	4260216454998				4.0	
AG12-BP10(0%Hg)	4260216455001				8.7	
AG13-BP10(0%Hg)	4260216455018	10.0				

0% Hg



Vergleichstabelle

AG0	LR521	G0			379
AG1	LR621	G1	LR60	164	364
AG2	LR726	G2	LR59	196	396
AG3	LR41	G3	LR41	192	392
AG4	LR626	G4	LR66	177	377
AG5	LR754	G5	LR48	193	393
AG6	LR921	G6	LR69	171	371
AG7	LR926	G7	LR57	195	395
AG8	LR1120	G8	LR55	191	391
AG9	LR936	G9	LR45	194	394
AG10	LR1130	G10	LR54	189	389
AG11	LR721	G11	LR58	162	362
AG12	LR43	G12	LR43	186	386
AG13	LR44	G13	LR44	A76	357

Remote Control Batterien 6V/12V



Artikel(0% Hg)	EAN	Volt (V)	Verpackung (B x H x T)(mm)	Verpackungseinheit (B x T x H)(mm)	Umkarton (B x T x H)(mm)	Gewicht (KG)	Volumen (CBM)
A11-BP1(0%Hg)	4260216455049	6V				7.6	
A23-BP1(0%Hg)	4260216455056	12V	56 x 92 x 10 1 PC / BLISTER	125 x 95 x 58 20 PACKS	39.5 x 30.5 x 31.5 900 PACKS	8.6	0.0380
A27-BP1(0%Hg)	4260216455063	12V				8.0	
LR32A-BP1(0%Hg)	4260216455070	9V				6.0	
A23-BP5(0%Hg)	4260216455087	12V				18.0	
A27-BP5(0%Hg)	4260216455094	12V	50 x 160 x 10 5 PCS / BLISTER	170 x 65 x 52 10 PACKS	42.0 x 36.0 x 18.0 360 PACKS	12.0	0.0273



4LR44-BP1C(0% Hg)

6V



Verpackung 1 pcs/pack
Blister 20 packs/box
Verpackungseinheit 900 packs/carton
Bruttogewicht: 15.0 kg
Volume: 0,0451 cbm

Abmaße
Blister (mm) 56(W)x 92(H) x (D)
Verpackungseinheit (mm) 145(L)x 95(W) x 58(H)
Umkarton (cm) 45.5(L)x 31.5(W) x 31.5(H)



4LR44-BP5(0%Hg)

6V



Verpackung 5 pcs/pack
Blister 6 packs/box
Verpackungseinheit 192 packs/carton
Bruttogewicht: 13.2 kg
Volume: 0,0150 cbm

Abmaße
Blister (mm) 50(W) x 160(H) x (D)
Verpackungseinheit (mm) 70(L) x 78(W) x 52(H)
Umkarton (cm) 33.5(L) x 19.0(W) x 23.5(H)



4LR43-BP1(0%Hg)

6V



Verpackung 1 pcs/pack
Blister 20 packs/box
Verpackungseinheit 900 packs/carton
Bruttogewicht: 15.0 kg
Volume: 0,0451 cbm

Abmaße
Blister (mm) 56(W)x 92(H) x (D)
Verpackungseinheit (mm) 145(L)x 95(W) x 58(H)
Umkarton (cm) 45.5(L)x 31.5(W) x 31.5(H)

Vergleichstabelle

SG0	SR521	G0	SR63	379
SG1	SR621	G1	SR60	364
SG2	SR726	G2	SR59	396
SG3	SR41	G3	SR41	392
SG4	SR626	G4	SR66	377
SG5	SR754	G5	SR48	393
SG6	SR921	G6	SR69	371
SG7	SR926	G7	SR57	395
SG8	SR1120	G8	SR55	391
SG9	SR936	G9	SR45	394
SG10	SR1130	G10	SR54	389
SG11	SR721	G11	SR58	362
SG12	SR43	G12	SR43	386
SG13	SR44	G13	SR44	357

Silber-Oxyd Knopfzellen 1.55V

0% Hg



Artikel (0% Hg)	EAN	Verpackung (B x H x T)(mm)	Verpackungseinheit (B x T x H)(mm)	Umkarton (B x T x H)(mm)	Gewicht (KG)	Volumen (CBM)
SR41-BP1(0%Hg)	4260216455117	55x 92 x 5 1 PC / BLISTER	145 x 95 x 58 40 PACKS	45.5 x 31.5 x 31.5 1800 PACKS	8.5	0.0451
SR43-BP1(0%Hg)	4260216455124				10.5	
SR44-BP1(0%Hg)	4260216455131				11.5	
SR54-BP1(0%Hg)	4260216455148				9.5	
SR57-BP1(0%Hg)	4260216455155				8.5	
SR58-BP1(0%Hg)	4260216455162				8	
SR59-BP1(0%Hg)	4260216455179				8	
SR60-BP1(0%Hg)	4260216455186				8	
SR63-BP1(0%Hg)	4260216455193				7.5	
SR66-BP1(0%Hg)	4260216455209				8	
SR69-BP1(0%Hg)	4260216455216	9.5				
SR41-BP5(0%Hg)	4260216455223	55x 190 x 5 5 PCS / BLISTER	195 x 90 x 58 20 PACKS	37.0 x 21.7 x 29.5 360 PACKS	4.5	0.0237
SR43-BP5(0%Hg)	4260216455230				6.5	
SR44-BP5(0%Hg)	4260216455247				7.5	
SR54-BP5(0%Hg)	4260216455254				5.5	
SR57-BP5(0%Hg)	4260216455261				4.5	
SR58-BP5(0%Hg)	4260216455278				4	
SR59-BP5(0%Hg)	4260216455285				4	
SR60-BP5(0%Hg)	4260216455292				4	
SR63-BP5(0%Hg)	4260216455308				3.5	
SR66-BP5(0%Hg)	4260216455315				4	
SR69-BP5(0%Hg)	4260216455322	5.5				

0% Hg



4SR44-BP1C(0% Hg)

6.2V



Verpackung
Blister 1 pcs/pack
Verpackungseinheit 20 packs/box
Umkarton 900 packs/carton

Bruttogewicht: 15.0 kg
Volume: 0.0451 cbm

Abmaße
Blister (mm) 56(W)x 92(H) x (D)
Verpackungseinheit (mm) 145(L)x 95(W) x 58(H)
Umkarton (cm) 45.5(L)x 31.5(W) x 31.5(H)

0% Hg



4SR44-Bulk

6.2V

Verpackung
Verpackungseinheit 32 packs/box
Umkarton 900 packs/carton

Bruttogewicht: 14.6 kg
Volume: 0.0104 cbm

Abmaße
Verpackungseinheit (mm) 102(L)x 52(W) x 30(H)
Umkarton (cm) 24.0(L)x 23.5(W) x 18.5(H)

Zink-Luft 1.4V

Camelion Hörgeräte Batterien sind klein, leicht, zuverlässig und praktisch verpackt, halt für die verbraucherfreundliche Handhabung.



Artikelnummer	EAN	Verpackung (B x H x T)(mm)		Verpackungseinheit (B x T x H)(mm)		Kleinkarton (B x T x H)(mm)		Umkarton (B x T x H)(mm)		Gewicht (KG)	Volumen (CBM)
A13-BP6(0%Hg)	4260216454417	48 x 90 x 6.5	6 ST. / BLISTER	92 x42 x 50	10 Packs	245 x 120 x 130	100 Packs	62 x 26 x 15	500 Packs	6.5	0.0242
A10-BP6(0%Hg)	4260216454486	48 x 90 x 4.5	6 ST. / BLISTER	92 x32 x 50	10 Packs	195 x 120 x 130	100 Packs	62 x 21 x 15	500 Packs	6.0	0.0196
A675-BP6(0%Hg)	4260216454493	48 x 90 x 6.5	6 ST. / BLISTER	92 x42 x 50	10 Packs	245 x 120 x 130	100 Packs	62 x 26 x 15	500 Packs	9.5	0.0242
A312-BP6(0%Hg)	4260216454509	48 x 90 x 4.5	6 ST. / BLISTER	92 x32 x 50	10 Packs	195 x 120 x 130	100 Packs	62 x 21 x 15	500 Packs	6.5	0.0196

Batterie Adapter



D Größe

C Größe



Für Akkus und Batterien



AA Batterie + Adapter

D oder C Größe



Achtung:

Wenn Sie zwei oder mehr Adapter gleichzeitig benutzen wollen, vermeiden Sie es, Batterien & Akkus mit unterschiedlichen Kapazitäten, Akkus mit unterschiedlichen Ladezuständen bzw. unterschiedlichen Marken / Typen zu verwenden. Mischen Sie die Adapter nicht mit ursprünglichen D Batterien aus Geräten. Bitte legen Sie AA-Batterien korrekt in die Adapter hinein bzw. achten auf die richtige Polarität. Entfernen Sie Batterien nach Gebrauch oder bei nicht längerer Benutzung. Lagern Sie die Adapter separat von den Batterien. Laden Sie die Akkus nicht während sie im Adapter sind.

Batterie-Aufbewahrungsbox

Eigenschaften

- Strapazierfähiger Kunststoff, passend für bis zu 4 AA/AAA Batterien.

Gebrauchsanweisung

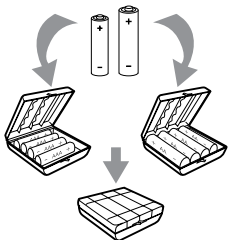

Batterie Tester



BT-0503

Testet AA, AAA, C, D, 9V und einige Knopfzellen Modelle

Eigenschaften

- Leicht & kompakt
- Erfahren Sie schnell, ob die Batterie ersetzt oder geladen werden muss
- Einfach einlegen und LED Anzeige prüfen

Batterie einlegen: Polarität beachten

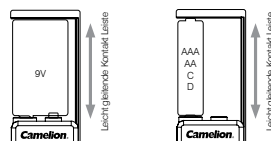

LED Anzeige prüfen: Wenn LED flackert, leicht drücken

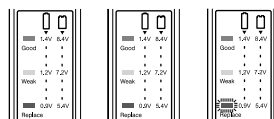

Grün: gut Gelb: schwach

Rot: nicht geladen
sofort aufladen
oder austauschen





















































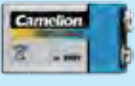

BT-0503



Verpackung

Bliester	1 St./Pack	Bruttogewicht:	8.7 kg
Verpackungseinheit	60 packs/box	Volumen:	0.0388 cbm
Umkarton	240 Packs/Karton		
Abmaße			
Bliester (mm)	65(B)x 154(H) x 16(T)		
Verpackungseinheit (mm)	44(B)x 11.5(T) x 16.5(H)		
Umkarton (cm)	45(B)x 34.5(T) x 25(H)		

Anwendungstabelle

Lithium P7 Batterie 	         
Digi Alkaline Batterie 	         
Plus Alkaline Batterie 	        
Super Heavy Duty Batterie 	    
Photo Lithium Batterie 	  
9V Lithium Batterie 	 
Knopfzelle: Lithium 	  
Knopfzelle: Alkaline 	  
Hörgerätebatterie Zink Luft 	

Bitte beachten Sie:

Es handelt sich hier nur um Empfehlungen.

Für die genauesten Informationen legen Sie bitte die Spezifikationen Ihres Geräte Herstellers zugrunde.

Camelion übernimmt keine Verantwortung für Störfälle / Unfälle gleich welcher Art, resultierend durch Anwendung dieser Informationen.

Spezifikationen

	Lithium P7		Digi Alkaline		Plus Alkaline							Super Heavy Duty							
	FR6	FR03	LR6	LR03	LR20	LR14	LR6	LR03	LR61	6LF22**	3LR12	R6	R03	R20	R14	6F22**	3R12*	4R25**	R10
Nennspannung(V)	1.5	1.5	1.5	1.5	1.5	1.5	1.5	1.5	1.5	9	4.5	1.5	1.5	1.5	1.5	9	4.5	6	1.5
Durchschnittliche Kapazität(mAh)	2800	1100	2800	1100	18000	8500	2800	1100	600	190**	2700*	950	460	5600	2400	450	1700	7000	500

20+2°C, Rated capacity at 25 mA continuous drain, to 0.8V

* 20+2°C, Rated capacity at 25 mA continuous drain, to 2.7V

** 20+2°C, Rated capacity at 25 mA continuous drain, to 4.8V

Ladegeräte und Akkus

AlwaysReady™ Akkus

Sind Sie es leid, Akkus das erste Mal aufladen zu müssen?

Der neue Camelion Always Ready Akku ist bereits 100 % vorgeladen und nach Erwerb sofort einsatzbereit.

Selbst bei Nichtnutzung bis zu einem Jahr hat dieser Akku noch ca. 80 % Restkapazität und somit eine geringere Selbstentladung als herkömmliche Akkus. Sind Sie bereit? Testen Sie jetzt!



NH-AA2500ARBP2

1.2V AA



Verpackung 4 2600216 453038
 Blister 2 St/Pack **Bruttogewicht:** 13.1 kg
 Verpackungseinheit 12 Packs/Box **Volumen:** 0.0274 cbm
 Umkarton 192 Packs/Karton

Abmaße
 Blister (mm) 90(B) x 117(H) x 15(T)
 Verpackungseinheit (mm) 134(B) x 104(T) x 97(H)
 Umkarton (cm) 41.0(B) x 29.0(T) x 23.0(H)



NH-9V200ARBP1

9V



Verpackung 4 260033 155221
 Blister 1 St/Pack **Bruttogewicht:** 12.0 kg
 Verpackungseinheit 12 Packs/Box **Volumen:** 0.0385 cbm
 Umkarton 240 Packs/Karton

Abmaße
 Blister (mm) 90(B) x 117(H) x 18(T)
 Verpackungseinheit (mm) 135(B) x 125(T) x 97(H)
 Umkarton (cm) 51.0(B) x 29.0(T) x 26.0(H)



NH-AA2300ARBP4

1.2V AA



Verpackung 4 260033 154040
 Blister 4 St/Pack **Bruttogewicht:** 11.8 kg
 Verpackungseinheit 12 Packs/Box **Volumen:** 0.0144 cbm
 Umkarton 96 Packs/Karton

Abmaße
 Blister (mm) 90(B) x 117(H) x 15(T)
 Verpackungseinheit (mm) 134(B) x 104(T) x 97(H)
 Umkarton (cm) 29.0(B) x 21.5(T) x 23.0(H)



NH-AA2300ARBP2

1.2V AA



Verpackung 4 260033 152336
 Blister 2 St/Pack **Bruttogewicht:** 12.9 kg
 Verpackungseinheit 12 Packs/Box **Volumen:** 0.0274 cbm
 Umkarton 192 Packs/Karton

Abmaße
 Blister (mm) 90(B) x 117(H) x 15(T)
 Verpackungseinheit (mm) 134(B) x 104(T) x 97(H)
 Umkarton (cm) 41.0(B) x 29.0(T) x 23.0(H)



NH-AAA800ARBP4

1.2V AAA



Verpackung 4 260033 152312
 Blister 4 St/Pack **Bruttogewicht:** 9.2 kg
 Verpackungseinheit 12 Packs/Box **Volumen:** 0.0168 cbm
 Umkarton 144 Packs/Karton

Abmaße
 Blister (mm) 90(B) x 117(H) x 11(T)
 Verpackungseinheit (mm) 125(B) x 84(T) x 97(H)
 Umkarton (cm) 31.0(B) x 27.0(T) x 20.0(H)



NH-AAA800ARBP2

1.2V AAA



Verpackung 4 260033 152305
 Blister 2 St/Pack **Bruttogewicht:** 8.4kg
 Verpackungseinheit 12 Packs/Box **Volumen:** 0.0269 cbm
 Umkarton 240 Packs/Karton

Abmaße
 Blister (mm) 90(B) x 117(H) x 11(T)
 Verpackungseinheit (mm) 125(B) x 84(T) x 97(H)
 Umkarton (cm) 51.0(B) x 27.0(T) x 19.5(H)



Energielösungen für solarbetriebene Geräte

Camelion Ni-MH Akkus sind perfekte Lösungen für solarbetriebene Outdoor-Geräte. Der Akku bietet eine längere Lebensdauer und ist herausragend in der Erhaltung seiner Energie, nach Aufladen durch solarbetriebene Geräte. Es ist die ideale Wahl für Outdoor-Geräte wie Solarleuchten.



NH-AA800ARBP2

1.2V AA



Verpackung	4 260216 453236	Bruttogewicht:	12.4 kg
Blister	2 St/Pack	Volumen:	0,0274 cbm
Verpackungseinheit	12 Packs/Box		
Umkarton	192 Packs/Karton		

Abmaße

Blister (mm)	90(B) x 117(H) x 15(T)
Verpackungseinheit (mm)	134(B) x 104(T) x 97(H)
Umkarton (cm)	41.0(B) x 29.0(T) x 23.0(H)



NH-AA600ARBP4(GSL)

1.2V AA



Verpackung	4 pcs/pack	Bruttogewicht:	11.4 kg
Blister	12 packs/box	Volumen:	0,0144 cbm
Verpackungseinheit	96 packs/carton		
Umkarton			

Abmaße

Blister (mm)	90(W) x 117(H) x 15(D)
Verpackungseinheit (mm)	134(L) x 104(W) x 97(H)
Umkarton (cm)	29.0(L) x 21.5(W) x 23.0(H)



NH-AAA600ARBP4(GSL)

1.2V AAA



Verpackung	4 pcs/pack	Bruttogewicht:	8.6 kg
Blister	12 packs/box	Volumen:	0,0168 cbm
Verpackungseinheit	144 packs/carton		
Umkarton			

Abmaße

Blister (mm)	90(W) x 117(H) x 11(D)
Verpackungseinheit (mm)	125(L) x 84(W) x 97(H)
Umkarton (cm)	31.0(L) x 27.0(W) x 20.0(H)

Ni-MH Akkus



Camelion bietet eine große Auswahl an Ni-MH Akkus mit hoher Leistungsfähigkeit bzw. -bereitschaft. Je nach Lade- und Nutzungsverhalten können diese bis zu 1.000 x wieder aufgeladen werden. Durch die mehrmalige Nutzungsmöglichkeit helfen Sie mit, die Umwelt zu schonen sowie Kosten zu sparen. Speziell Anwender, die Geräte mit überdurchschnittlich hohem Stromverbrauch nutzen (Musikplayer oder Digital Kameras), können sich an einem längerem Musikgenuss bzw. mehr Bildern erfreuen.

NH-D1000BP2



1.2V D



Verpackung	4 [#] 260033 [#] 151865 [#]	Bruttogewicht:	17.0 kg
Blister	2 St/Pack	Volumen:	0.0244 cbm
Verpackungseinheit	6 Packs/Box		
Umkarton	48 Packs/Karton		

Abmaße

Blister (mm)	90(B) x 117(H) x 34(T)
Verpackungseinheit (mm)	165(B) x 135(T) x 105(H)
Umkarton (cm)	43.5(B) x 35.0(T) x 16.0(H)

NH-D7000BP2



1.2V D



Verpackung	4 [#] 260033 [#] 151520 [#]	Bruttogewicht:	19.0 kg
Blister	2 St/Pack	Volumen:	0.0234 cbm
Verpackungseinheit	6 Packs/Box		
Umkarton	60 Packs/Karton		

Abmaße

Blister (mm)	90(B) x 117(H) x 34(T)
Verpackungseinheit (mm)	160(B) x 112(T) x 97(H)
Umkarton (cm)	34.0(B) x 27.5(T) x 25.0(H)

NH-D2500BP2



1.2V D



Verpackung	4 [#] 260033 [#] 151537 [#]	Bruttogewicht:	11.2 kg
Blister	2 St/Pack	Volumen:	0.0234 cbm
Verpackungseinheit	6 Packs/Box		
Umkarton	60 Packs/Karton		

Abmaße

Blister (mm)	90(B) x 117(H) x 34(T)
Verpackungseinheit (mm)	160(B) x 112(T) x 97(H)
Umkarton (cm)	34.0(B) x 27.5(T) x 25.0(H)

NH-C3500BP2



1.2V C



Verpackung	4 [#] 260033 [#] 151544 [#]	Bruttogewicht:	16.8 kg
Blister	2 St/Pack	Volumen:	0.0248 cbm
Verpackungseinheit	6 Packs/Box		
Umkarton	96 Packs/Karton		

Abmaße

Blister (mm)	90(B) x 117(H) x 27(T)
Verpackungseinheit (mm)	138(B) x 90(T) x 97(H)
Umkarton (cm)	41.0(B) x 29.5(T) x 20.5(H)

NH-C2500BP2



1.2V C



Verpackung	4 [#] 260033 [#] 151551 [#]	Bruttogewicht:	16.0 kg
Blister	2 St/Pack	Volumen:	0.0248 cbm
Verpackungseinheit	6 Packs/Box		
Umkarton	96 Packs/Karton		

Abmaße

Blister (mm)	90(B) x 117(H) x 27(T)
Verpackungseinheit (mm)	138(B) x 90(T) x 97(H)
Umkarton (cm)	41.0(B) x 29.5(T) x 20.5(H)

NH-AA2700BC4



1.2V AA



Verpackung	4 [#] 260033 [#] 151933 [#]	Bruttogewicht:	13.4 kg
Blister	4 St/Pack	Volumen:	0.0144 cbm
Verpackungseinheit	12 Packs/Box		
Umkarton	96 Packs/Karton		

Abmaße

Blister (mm)	90(B) x 117(H) x 15(T)
Verpackungseinheit (mm)	134(B) x 104(T) x 97(H)
Umkarton (cm)	29.0(B) x 21.5(T) x 23.0(H)

NH-AA2700BC2



1.2V AA



Verpackung	4 [#] 260033 [#] 151926 [#]	Bruttogewicht:	14.0 kg
Blister	2 St/Pack	Volumen:	0.0274 cbm
Verpackungseinheit	12 Packs/Box		
Umkarton	192 Packs/Karton		

Abmaße

Blister (mm)	90(B) x 117(H) x 15(T)
Verpackungseinheit (mm)	134(B) x 104(T) x 97(H)
Umkarton (cm)	41.0(B) x 29.0(T) x 23.0(H)



NH-AA2500BC4

1.2V AA 4 260033 151834

Verpackung
Blister 4 St/Pack
Verpackungseinheit 12 Packs/Box
Umkarton 96 Packs/Karton

Bruttogewicht: 13.0 kg
Volumen: 0.0144 cbm

Abmaße
Blister (mm) 90(B) x 117(H) x 15(T)
Verpackungseinheit (mm) 134(B) x 104(T) x 97(H)
Umkarton (cm) 29.0(B) x 21.5(T) x 23.0(H)



NH-AA2500BC2

1.2V AA 4 260033 151827

Verpackung
Blister 2 St/Pack
Verpackungseinheit 12 Packs/Box
Umkarton 192 Packs/Karton

Bruttogewicht: 14.3 kg
Volumen: 0.0274 cbm

Abmaße
Blister (mm) 90(B) x 117(H) x 15(T)
Verpackungseinheit (mm) 134(B) x 104(T) x 97(H)
Umkarton (cm) 41.0(B) x 29.0(T) x 23.0(H)



NH-AA2300BP4

1.2V AA 4 260033 151742

Verpackung
Blister 4 St/Pack
Verpackungseinheit 12 Packs/Box
Umkarton 96 Packs/Karton

Bruttogewicht: 12.6 kg
Volumen: 0.0144 cbm

Abmaße
Blister (mm) 90(B) x 117(H) x 15(T)
Verpackungseinheit (mm) 134(B) x 104(T) x 97(H)
Umkarton (cm) 29.0(B) x 21.5(T) x 23.0(H)



NH-AA2300BP2

1.2V AA 4 260033 151735

Verpackung
Blister 2 St/Pack
Verpackungseinheit 12 Packs/Box
Umkarton 192 Packs/Karton

Bruttogewicht: 13.9 kg
Volumen: 0.0274 cbm

Abmaße
Blister (mm) 90(B) x 117(H) x 15(T)
Verpackungseinheit (mm) 134(B) x 104(T) x 97(H)
Umkarton (cm) 41.0(B) x 29.0(T) x 23.0(H)



NH-AA2000BP2

1.2V AA 4 260033 151582

Verpackung
Blister 2 St/Pack
Verpackungseinheit 12 Packs/Box
Umkarton 192 Packs/Karton

Bruttogewicht: 13.1 kg
Volumen: 0.0274 cbm

Abmaße
Blister (mm) 90(B) x 117(H) x 15(T)
Verpackungseinheit (mm) 134(B) x 104(T) x 97(H)
Umkarton (cm) 41.0(B) x 29.0(T) x 23.0(H)



NH-AA1800BP4

1.2V AA 4 260033 151612

Verpackung
Blister 4 St/Pack
Verpackungseinheit 12 Packs/Box
Umkarton 96 Packs/Karton

Bruttogewicht: 11.8 kg
Volumen: 0.0144 cbm

Abmaße
Blister (mm) 90(B) x 117(H) x 15(T)
Verpackungseinheit (mm) 134(B) x 104(T) x 97(H)
Umkarton (cm) 29.0(B) x 21.5(T) x 23.0(H)



NH-AA1800BP2

1.2V AA 4 260033 151605

Verpackung
Blister 2 St/Pack
Verpackungseinheit 12 Packs/Box
Umkarton 192 Packs/Karton

Bruttogewicht: 12.7 kg
Volumen: 0.0274 cbm

Abmaße
Blister (mm) 90(B) x 117(H) x 15(T)
Verpackungseinheit (mm) 134(B) x 104(T) x 97(H)
Umkarton (cm) 41.0(B) x 29.0(T) x 23.0(H)



NH-AA1500BP2

1.2V AA 4 260033 151629

Verpackung
Blister 2 St/Pack
Verpackungseinheit 12 Packs/Box
Umkarton 192 Packs/Karton

Bruttogewicht: 11.2 kg
Volumen: 0.0274 cbm

Abmaße
Blister (mm) 90(B) x 117(H) x 15(T)
Verpackungseinheit (mm) 134(B) x 104(T) x 97(H)
Umkarton (cm) 41.0(B) x 29.0(T) x 23.0(H)



NH-AAA1100BP4

1.2V AAA



Verpackung 4 260033 151957
 Blister 4 St/Pack **Bruttogewicht:** 9.8 kg
 Verpackungseinheit 12 Packs/Box **Volumen:** 0.0168 cbm
 Umkarton 144 Packs/Karton

Abmaße
 Blister (mm) 90(B) x 117(H) x 11(T)
 Verpackungseinheit (mm) 125(B) x 84(T) x 97(H)
 Umkarton (cm) 31.0(B) x 27.0(T) x 20.0(H)



NH-AAA1100BP2

1.2V AAA



Verpackung 4 260033 151940
 Blister 2 St/Pack **Bruttogewicht:** 9.7 kg
 Verpackungseinheit 12 Packs/Box **Volumen:** 0.0269 cbm
 Umkarton 240 Packs/Karton

Abmaße
 Blister (mm) 90(B) x 117(H) x 11(T)
 Verpackungseinheit (mm) 125(B) x 84(T) x 97(H)
 Umkarton (cm) 51.0(B) x 27.0(T) x 19.5(H)



NH-AAA1000BP4

1.2V AAA



Verpackung 4 260033 151889
 Blister 4 St/Pack **Bruttogewicht:** 8.7 kg
 Verpackungseinheit 12 Packs/Box **Volumen:** 0.0168 cbm
 Umkarton 144 Packs/Karton

Abmaße
 Blister (mm) 90(B) x 117(H) x 11(T)
 Verpackungseinheit (mm) 125(B) x 84(T) x 97(H)
 Umkarton (cm) 31.0(B) x 27.0(T) x 20.0(H)



NH-AAA1000BP2

1.2V AAA



Verpackung 4 260033 151872
 Blister 2 St/Pack **Bruttogewicht:** 8.7 kg
 Verpackungseinheit 12 Packs/Box **Volumen:** 0.0269 cbm
 Umkarton 240 Packs/Karton

Abmaße
 Blister (mm) 90(B) x 117(H) x 11(T)
 Verpackungseinheit (mm) 125(B) x 84(T) x 97(H)
 Umkarton (cm) 51.0(B) x 27.0(T) x 19.5(H)



NH-AAA900BP4

1.2V AAA



Verpackung 4 260033 151766
 Blister 4 St/Pack **Bruttogewicht:** 8.7 kg
 Verpackungseinheit 12 Packs/Box **Volumen:** 0.0168cbm
 Umkarton 144 Packs/Karton

Abmaße
 Blister (mm) 90(B) x 117(H) x 11(T)
 Verpackungseinheit (mm) 125(B) x 84(T) x 97(H)
 Umkarton (cm) 31.0(B) x 27.0(T) x 20.0(H)



NH-AAA900BP2

1.2V AAA



Verpackung 4 260033 151759
 Blister 2 St/Pack **Bruttogewicht:** 8.7kg
 Verpackungseinheit 12 Packs/Box **Volumen:** 0.0269 cbm
 Umkarton 240 Packs/Karton

Abmaße
 Blister (mm) 90(B) x 117(H) x 11(T)
 Verpackungseinheit (mm) 125(B) x 84(T) x 97(H)
 Umkarton (cm) 51.0(B) x 27.0(T) x 19.5(H)



NH-AAA800BP2

1.2V AAA



Verpackung 4 260033 151667
 Blister 2 St/Pack **Bruttogewicht:** 7.7kg
 Verpackungseinheit 12 Packs/Box **Volumen:** 0.0269 cbm
 Umkarton 240 Packs/Karton

Abmaße
 Blister (mm) 90(B) x 117(H) x 11(T)
 Verpackungseinheit (mm) 125(B) x 84(T) x 97(H)
 Umkarton (cm) 51.0(B) x 27.0(T) x 19.5(H)



NH-AAA600BP4

1.2V AAA



Verpackung
Blister 4 St/Pack
Verpackungseinheit 12 Packs/Box
Umkarton 144 Packs/Karton

Bruttogewicht: 7.8 kg
Volumen: 0.0168 cbm

Abmaße
Blister (mm) 90(B) x 117(H) x 11(T)
Verpackungseinheit (mm) 125(B) x 84(T) x 97(H)
Umkarton (cm) 31.0(B) x 27.0(T) x 20.0(H)



NH-AAA600BP2

1.2V AAA



Verpackung
Blister 2 St/Pack
Verpackungseinheit 12 Packs/Box
Umkarton 240 Packs/Karton

Bruttogewicht: 7.7 kg
Volumen: 0.0269 cbm

Abmaße
Blister (mm) 90(B) x 117(H) x 11(T)
Verpackungseinheit (mm) 125(B) x 84(T) x 97(H)
Umkarton (cm) 51.0(B) x 27.0(T) x 19.5(H)



NH-9V250BP1

9V Spannung: 8.4V



Verpackung
Blister 1 St/Pack
Verpackungseinheit 12 Packs/Box
Umkarton 240 Packs/Karton

Bruttogewicht: 12.3 kg
Volumen: 0.0385 cbm

Abmaße
Blister (mm) 90(B) x 117(H) x 18(T)
Verpackungseinheit (mm) 135(B) x 125(T) x 97(H)
Umkarton (cm) 51.0(B) x 29.0(T) x 26.0(H)



NH-9V200BP1

9V Spannung: 8.4V



Verpackung
Blister 1 St/Pack
Verpackungseinheit 12 Packs/Box
Umkarton 240 Packs/Karton

Bruttogewicht: 11.6 kg
Volumen: 0.0385 cbm

Abmaße
Blister (mm) 90(B) x 117(H) x 18(T)
Verpackungseinheit (mm) 135(B) x 125(T) x 97(H)
Umkarton (cm) 51.0(B) x 29.0(T) x 26.0(H)



Lithium-Ion Akkus

- Anwendbar für bis zu 500 Lade-Entlade-Zyklen
- weiter Betriebstemperaturbereich
- Hält 85% der Kapazität über 6 Monate lang



ICR18650F-26

3.7V 2600



Verpackung
Verpackungseinheit 24 Packs/Box
Umkarton 384 Packs/Karton

Bruttogewicht: 17.16kg
Volumen: 0.0128 cbm

Abmaße
Verpackungseinheit (mm) 120(L) x 80(W) x 70(H)
Umkarton (cm) 33(L) x 25(W) x 15.5(H)



ICR18650F-22

3.7V 2200



Verpackung
Verpackungseinheit 24 Packs/Box
Umkarton 384 Packs/Karton

Bruttogewicht: 16kg
Volumen: 0.0128 cbm

Abmaße
Verpackungseinheit (mm) 120(L) x 80(W) x 70(H)
Umkarton (cm) 33(L) x 25(W) x 15.5(H)



Akkus Ladegerät



> Ultra Schnell Ladegerät

Bietet das Optimale an Schnellladung. In weniger als einer Stunde kann der selbe Akku wieder genutzt werden, spart Zeit und Geld.

Camelion®

BC-0907

Lädt:

1-4 x 

1-4 x 

Ni-MH



AC Adapter



Car Adapter



L00406A

Spezifikationen:

AC/DC Adapter

Input: 100-240V~50/60Hz

Output: 12V ---

KFZ Adapter

Output: 12V ---

Ladestrom

4x(1.4V --- 2200 mA) AA Akku

4x(1.4V --- 800 mA) AAA Akku

Eigenschaften:

- 4 unabhängige Ladekanäle
- 6-fache Sicherheit
 - Mikroprozessor gesteuerte Einzelkanalüberwachung/-ladung (ΔV -Erkennung)
 - Sicherheitsabschaltung nach 1,5 Stunden (Timer Control)
 - Überhitzungsschutz
 - Polarisationschutz
 - Überspannungs- und Kurzschlusschutz
 - Erkennt defekte/nicht aufladbare Zellen
- Niedrige Kriechströme
- Erhaltungsladung
- Weltweite Nutzung möglich
- Akku Refresh Funktion
- KFZ Adapter
- Kontinuierliche Impulsladung für effizientes Laden
- Leicht abzulesendes LCD Display

Refresh

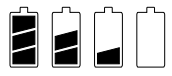

Aufladung

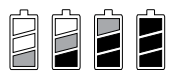

Ladezeiten:

Akkutyp	Ladezeiten (ca.)
AA Ni-MH 2700mAh	80 Minuten
AA Ni-MH 2000mAh	60 Minuten
AA Ni-MH 1500mAh	50 Minuten
AAA Ni-MH 800mAh	70 Minuten

Erhältliche Farben:

 Silber  Schwarz

BARCODE

BC-0907



4 260033 157706

BC0907-UK-0



4 260216 456640

Verpackung

UK



Blister

Stecker:	TUV
Gewicht(g)	336
Abmaße (B) x (H) x (T) (mm)	125 x 205 x 67

Innerer Karton

Packs	8
Nettogewicht(kg)	2.7
Bruttogewicht(kg)	3.25
Abmaße (B) x (T) x (H) (cm)	52 x 27 x 19

Umkarton

Packs	16
Nettogewicht(kg)	5.4
Bruttogewicht(kg)	7
Abmaße (B) x (T) x (H) (cm)	45.4 x 28.5 x 40.5
Volumen(cbm)	0.0629

> Super Schnell Ladegeräte

Laden die meisten Akkus in 1 bis 4 Stunden
 Sie verfügen über mehrfachen Sicherheitsschutz und weitere Eigenschaften wie LED Displays zum Anzeigen des aktuellen Ladezustandes, weltweit nutzbar (Eingangsspannung: 100V – 240V)

BC-0905A

Lädt:

1 or 4 × AA

1 or 4 × AAA

Ni-MH



Flip plug

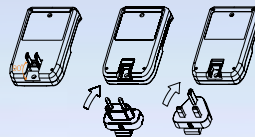

*Different plug models for different countries



Spezifikationen:

Input: 100-240V~50/60Hz

Output: AA: 1000mA (1- 2 pcs),
 500mA (3-4 pcs)

AAA: 600mA (1- 2 pcs),
 300mA (3-4 pcs)

Eigenschaften:

- 4 unabhängige Ladekanäle
- 6-fache Sicherheit
 - ΔV-Erkennung
 - Sicherheitsabschaltung nach 3,5 Stunden (1-2 Zellen) oder 7 Stunden (3-4 Zellen)
 - Überhitzungsschutz
 - Polarisierungsschutz
 - Überspannungs- und Kurzschlusschutz Erkennt defekte und nicht-aufladbare Zellen
- Erhaltungsladung
- wechselbare Adapter
- LED Anzeige

rot	laden
blinken	defekte und nicht-aufladbare Zellen / Kurzschluss
grün	voll aufgeladen / Erhaltungsladung

Ladezeiten:

Akkutyp	Ladezeiten (ca.)	
	1-2 Zellen	3-4 Zellen
Ni-MH AA 2700 mAh	3 Stunden	6 Stunden
Ni-MH AA 2000 mAh	2.5 Stunden	4.5 Stunden
Ni-MH AA 1500 mAh	2 Stunden	3.5 Stunden
Ni-MH AAA 800 mAh	100 min	3 Stunden
Ni-Cd AA 1000 mAh	70 min	2 Stunden
Ni-Cd AAA 300 mAh	40 min	70 min

Erhältliche Farben:

 Schwarz

BARCODE

BC-0905A-UK-0



Verpackung

UK



Blister		
Plug:	TUV	UK
Weight(g)	153	144
Dimensions(W)x(H)x(D)(mm)	125x205x70	125x205x70
Inner Carton		
Packs / Inner ctn	16	16
Net Weight(kg)	2.45	2.3
Gross Weight(kg)	3	3
Dimensions(L)x(W)x(H)(cm)	48.5x22.5x27	48.5x22.5x27
Outer Carton		
Packs / Carton	32	32
Net Weight(kg)	4.9	4.8
Gross Weight(kg)	6.4	6.3
Dimensions(L)x(W)x(H)(cm)	51x 47 x 29	50 x 47 x 29
Volume(cbm)	0.0682	0.0682

> Schnell Ladegeräte

Laden die meisten Akkus in 4 bis 8 Stunden.
Leistungsstarkes Paket, flexible Nutzung für zu Hause, im Büro und für unterwegs.

BC-1010B

Lädt:

2 or 4 × AA

2 or 4 × AAA

Ni-MH



*Different plug models for different countries



Spezifikationen:

Input: 100-240V ~ 50/60Hz 4W Max.
Output: 2 x (2.8V = 200mA) AA/AAA Akku

Eigenschaften:

- 2 unabhängige Ladekanäle
- Polarisierungsschutz
- Weltweite Nutzung möglich
- 2 LED Anzeigen

Rot | Laden oder komplett geladen

Ladezeiten:

Akkutyp	Ladezeiten (ca.)
Ni-MH AA 2700 mAh	17 Stunden
Ni-MH AA 2000 mAh	14 Stunden
Ni-MH AA 1500 mAh	11 Stunden
Ni-MH AAA 800 mAh	5 Stunden
Ni-Cd AA 1000 mAh	6 Stunden
Ni-Cd AAA 300 mAh	2 Stunden

Erhältliche Farben:

 Schwarz

BARCODE





Verpackung



Blister	
Plug:	TUV
Weight(g)	118.2
Dimensions(W)x(H)x(D)(mm)	125 x 204 x 76
Inner Carton	
Packs / Inner ctn	8
Net Weight(kg)	0.95
Gross Weight(kg)	1.3
Dimensions(L)x(W)x(H)(cm)	49.5 x 23.5 x 14
Outer Carton	
Packs / Carton	32
Net Weight(kg)	3.78
Gross Weight(kg)	5.5
Dimensions(L)x(W)x(H)(cm)	50.5 x 48.5 x 30
Volume(cbm)	0.0735

BC-1002A

Lädt:

2 oder 4 ×  **Ni-MH**
 2 oder 4 × 



AC Kabel



Spezifikationen:

Input: 100-240V ~ 50/60Hz
 Output: 2x(2.8V = 300mA) AA Akku
 2x(2.8V = 150mA) AAA Akku

Eigenschaften:

- Weltweite Nutzung möglich
- Sicherheitsabschaltung nach 8 Stunden
- Polarisierungsschutz
- Erhaltungsladung

• LED Anzeigen

LED an	Laden
LED aus	Voll aufgeladen oder kein Akku eingesetzt

Ladezeiten:

Akkutyp	Ladezeiten (ca.)
AA Ni-MH 2700mAh	8 Stunden
AA Ni-MH 2000mAh	8 Stunden
AA Ni-MH 1500mAh	6 Stunden
AAA Ni-MH 800mAh	8 Stunden

Erhältliche Farben:

 Schwarz

BARCODE





Verpackung



Blister	
Stecker:	TUV
Gewicht(g)	118
Abmaße (B) x (H) x (T) (mm)	125 x 205 x 85
Innerer Karton	
Packs	16
Nettogewicht(kg)	1.89
Bruttogewicht(kg)	3.42
Abmaße (B)x (T) x (H) (cm)	46 x 24.5 x 27
Umkarton	
Packs	32
Nettogewicht(kg)	3.8
Bruttogewicht(kg)	7.53
Abmaße (B)x (T) x (H) (cm)	51 x 47.5 x 29
Volumen(cbm)	0.0703

BC-1012

Lädt:

1-4 x 
1-4 x 

Ni-MH



Spezifikationen:

Input: 100-240V~50/60Hz 5W

Output: 1.4V =

AA : 400 mA (1~2 Akkus); 260 mA (3 Akkus); 200 mA (4 Akkus)
AAA : 200 mA (1~2 Akkus); 130 mA (3 Akkus); 100 mA (4 Akkus)

Eigenschaften:

- Lädt bis zu 4 AA / AAA Ni-MH / Ni-Cd Akkus.
- Multi-Band LCD-Monitor (Anzeige für Ladevorgang, defekte Zellen)
- 4 unabhängige Ladekanäle
- Polarisierungsschutz
- Kontinuierliche Impulsladung für effizientes Laden
- Mikroprozessor gesteuerte Einzelkanalüberwachung / -ladung (ΔV -Erkennung)
- Überspannungsschutz
- Kurzschlusschutz
- Sicherheitsabschaltung (Timer Controller) (1 - 2 Akkus nach 6 Stunden, 3 Akkus nach 9 Stunden und 4 Akkus nach 12 Stunden)

Ladezeiten:

Akkutyp	Ladezeiten (ca.)		
	1-2 Akku	3 Akkus	4 Akkus
Ni-MH AA 2700 mAh	6 Stunden	9 Stunden	12 Stunden
Ni-MH AA 2000 mAh	6 Stunden	9 Stunden	12 Stunden
Ni-MH AAA 1000 mAh	6 Stunden	9 Stunden	12 Stunden
Ni-MH AAA 800 mAh	5 Stunden	8.5 Stunden	11 Stunden

Erhältliche Farben:

Weiß

BARCODE



Verpackung



Blister	
Stecker:	TUV
Gewicht(g)	118.2
Abmaße (B) x (H) x (T) (mm)	125 x 205x 75
Innerer Karton	
Packs	8
Nettogewicht(kg)	0.95
Bruttogewicht(kg)	1.3
Abmaße (B)x (T) x (H) (cm)	49.5 x 23.5 x 14
Umkarton	
Packs	32
Nettogewicht(kg)	3.78
Bruttogewicht(kg)	5.5
Abmaße (B) x (T) x (H) (cm)	50.5 x 48.5 x 30
Volumen(cbm)	0.0735

> Steckerladergeräte

Standard Akku Ladegeräte, sind ideal für den regelmäßigen Gebrauch im Haushalt und im Büro.

BC-1001A

Lädt:

1-2 x AA

1-2 x AAA

1 x 9V

Ni-MH



Spezifikationen:

Input: 100-240V ~ 50/60Hz
 Output: 2 x (1.4V = 200 mA) AA/AAA Akkus
 1 x (9V = 25 mA) 9V Akku

Eigenschaften:

- 3 unabhängige Ladekanäle
- Sicherheitsabschaltung nach 12 Stunden
- Polarisierungsschutz
- Klein und handlich
- Weltweite Nutzung möglich
- LED Leuchtdioden

Rot	laden
Aus	voll geladen

Ladezeiten:

Akkutyp	Ladezeiten (ca.)
Ni-MH AA 2700 mAh	12 Stunden
Ni-MH AA 2000 mAh	12 Stunden
Ni-MH AA 1500 mAh	10.5 Stunden
Ni-MH AAA 800 mAh	5 Stunden
Ni-MH 9V 200 mAh	9.5 Stunden

Erhältliche Farben:

Titanium Schwarz

BARCODE



Verpackung



Blister	
Stecker:	TUV
Gewicht(g)	62
Abmaße (B) x (H) x (T) (mm)	87 x 172 x 50
Innerer Karton	
Packs	32
Nettogewicht(kg)	1.98
Bruttogewicht(kg)	2.42
Abmaße (B)x (T) x (H) (cm)	39.5 x 37.5 x 18
Umkarton	
Packs	64
Nettogewicht(kg)	4.0
Bruttogewicht(kg)	7.5
Abmaße (B) x (T) x (H) (cm)	41 x 39 x 39
Volumen(cbm)	0.0624

BC-0904S

Lädt:

2 oder 4 x AA

2 oder 4 x AAA

1-2 x 9V

Ni-MH



Spezifikationen:

Input: 230V ~ 50Hz

Output: 2 x (2.8V \approx 160 mA) AA Akkus

2 x (2.8V \approx 80 mA) AAA Akkus

2 x (9V \approx 25 mA) 9V Akkus

Eigenschaften:

- 2 unabhängige Ladekanäle
- Niedrige Kriechströme für ein längeres Akkuleben
- Polarisationschutz
- LED Leuchtdioden

Rot	laden oder komplett geladen
-----	-----------------------------

Ladezeiten:

Akkutyp	Ladezeiten (ca.)
Ni-MH AA 2000 mAh	17 Stunden
Ni-MH AA 1500 mAh	13 Stunden
Ni-MH AAA 800 mAh	14 Stunden
Ni-MH 9V 200 mAh	9.5 Stunden

Erhältliche Farben:

 Silber

BARCODE





Verpackung



Blister	
Stecker:	TUV
Gewicht(g)	274
Abmaße (B) x (H) x (T) (mm)	210 x 130 x 84
Innerer Karton	
Packs	4
Nettogewicht(kg)	1.1
Bruttogewicht(kg)	1.3
Abmaße (B)x (T) x (H) (cm)	49.5 x 9 x 21.5
Umkarton	
Packs	16
Nettogewicht(kg)	4.4
Bruttogewicht(kg)	7.5
Abmaße (B) x (T) x (H) (cm)	51 x 39 x 23.5
Volumen(cbm)	0.0454

BC-0901

Lädt:

1-2 × 
1-2 × 

Ni-MH



Spezifikationen:

Input: 100-240V ~ 50/60Hz 3W Max.
Output: 2 x (1.4V = 150mA) AA/AAA size

Eigenschaften:

- 2 unabhängige Ladekanäle
- Polarisationschutz
- LED Leuchtdioden

Rot laden oder komplett geladen

Ladezeiten:

Akkutyp	Ladezeiten (ca.)
Ni-MH AA 2000 mAh	19 Stunden
Ni-MH AA 1800 mAh	17 Stunden
Ni-MH AAA 800 mAh	8 Stunden

Erhältliche Farben:

 Silber

BARCODE



Verpackung



Blister	
Stecker:	TUV
Gewicht(g)	155
Abmaße (B) x (H) x (T) (mm)	125 x 205 x 80
Innerer Karton	
Packs	16
Nettogewicht(kg)	2.48
Bruttogewicht(kg)	2.73
Abmaße (B)x (T) x (H) (cm)	39.5 x 23.5 x 12.5
Umkarton	
Packs	32
Nettogewicht(kg)	4.96
Bruttogewicht(kg)	7.2
Abmaße (B)x (T) x (H) (cm)	48.5 x 41 x 27
Volumen(cbm)	0.0537

> Universal Ladegeräte

können die verschiedenen Akkus immer wieder aufladen und sind perfekt für Haushalte mit hohem Batterienverbrauch. Sie sind verlässlich, sicher und können sogar anzeigen, ob es Zeit ist die Akkus aufzuladen.

CM9398GS

Lädt:

1- 4 AA / AAA / D / C or 1-2 9V
Ni-MH Akkus



Spezifikationen:

Input: 230V~50Hz
Output: 4 x (1.4V \approx 250mA) D/C/AA/AAA
2 x (9V \approx 13mA) 9V

Eigenschaften:

- 4 Kanäle für AAA, AA, C, D, und 2 Kanäle für 9V Akkus
- Eingebauter Akkutester
- Einstellbarer Timer (3, 6, 9, 24 Stunden)
- Erhaltungsladung
- Überladungsschutz

Ladezeiten:

Akkutyp	Ladezeiten (ca.)
D Ni-MH 2500mAh	24 Stunden
C Ni-MH 2500mAh	24 Stunden
AA Ni-MH 2500mAh	24 Stunden
AAA Ni-MH 900mAh	6 Stunden
9V Ni-MH 200mAh	20 Stunden

Erhältliche Farben:

 Schwarz

BARCODE



Verpackung



Blister	
Gewicht(g)	680
Abmaße (B) x (H) x (T) (mm)	330 x 175 x 60
Innerer Karton	
Packs	10
Bruttogewicht(kg)	7.32
Abmaße (B) x (T) x (H) (cm)	59 x 23.5 x 19.5
Umkarton	
Packs	20
Nettogewicht(kg)	13.7
Bruttogewicht(kg)	16.0
Abmaße (B) x (T) x (H) (cm)	62 x 36 x 46
Volumen(cbm)	0.10

CM3298

Lädt:

1 - 4 C / D + 1 - 2 9V
 1 - 6 AA / AAA + 1 - 2 9V
 Ni-MH Akkus



Spezifikationen

Eingangsstrom: AC/DC Adapter 100-240V 50/60HZ 30W
 Ladestrom: 4 x C oder D (DC 1,2V 4 x ca. 1000mA),
 6 x AAA (DC 1,2V 6 x ca. 500mA),
 6 x AA (DC 1,2V 6 x ca. 1000mA),
 2 x 9V Block (DC 9V 2 x ca. 70mA)
 USB 5V: ca. 500mA max.
 Erhaltungsladestrom: DC 1,2V 50-100mA

Eigenschaften:

8 unabhängige Ladekanäle für zeitgleiches Laden von Ni-CD/Ni-MH Akkus:
 1-4 Baby C/Mono D + 1-2 9V Block oder 1-6 Mignon AA/Micro AAA + 1-2 9V Block

LCD Display zeigt den individuellen Ladestatus der einzelnen Akkus an

6-fache Sicherheit:

Mikroprozessor gesteuerte Einzelkanalüberwachung/-ladung (ΔV Erkennung)
 Sicherheitsabschaltung nach 10 Stunden
 Überhitzungsschutz
 Polarisationschutz
 Überspannungs- und Kurzschlusschutz
 Erkennung von defekten/nicht aufladbaren Zellen

USB Anschluss ermöglicht das Aufladen von externen Geräten wie MP3 Playern oder Mobiltelefonen

Entladefunktion 9V Block Akkus können nicht entladen werden

Erhaltungsladefunktion

weltweite Nutzung möglich

Display	LED	Erläuterung
		laden beendet; LED leuchtet grün
		entladen; LED blinkt abwechselnd grün/rot
		laden; LED leuchtet rot
		Ladefehler - der Akku wurde falsch eingesetzt oder ist beschädigt; LED blinkt rot
		Akkus werden vorgeladen und geprüft; LED blinkt grün

Ladezeiten:

Akkutyp	Ladezeiten (ca.)
Ni-MH AA 2500 mAh	3.5 Stunden
Ni-MH AAA 900 mAh	2.5 Stunden
Ni-MH C 4000 mAh	5.5 Stunden
Ni-MH D 4500 mAh	6.0 Stunden
Ni-MH 9V 200 mAh	4.0 Stunden

Erhältliche Farben:

Silber

BARCODE



Verpackung



Blister	
Stecker:	TUV
Gewicht(g)	660
Abmaße (B) x (H) x (T) (mm)	241.5 x 60 x 215
Umkarton	
Packs	10
Nettogewicht(kg)	6.6
Bruttogewicht(kg)	7.3
Abmaße (B)x (T) x (H) (cm)	32 x 44.5 x 24
Volumen(cbm)	0.0341

CM9388

Lädt:

1- 4 AA / AAA / D / C or 1-2 9V
Ni-MH Akkus



Spezifikationen:

AC / DC Adapter

Input : AC 100 ~ 240V 50/60 Hz
Output : 12V DC 1A

Ladegerät

Ladestrom
Input: DC 12V
Output:
4 x (1.4V \approx 300mA) D/C/AA/AAA Size
2 x (9V \approx 13mA) 9V Size

Eigenschaften:

- 2 unabhängige Ladekanäle
- Lädt AAA/AA/C/D/9V Ni-MH/Ni-Cd Akkus
- Delta V Erkennung
- Entladefunktion
- Überladungsschutz

Ladezeiten:

Akkutyp	Ladezeiten (ca.)
AA Ni-MH 2700mAh	4 Stunden
AA Ni-MH 1500mAh	7,5 Stunden
AAA Ni-MH 1100mAh	2,5 Stunden
9V Ni-MH 250mAh	2,3 Stunden
D Ni-MH 2500mAh	4 Stunden
C Ni-MH 2500mAh	4 Stunden

Erhältliche Farben:

Schwarz

BARCODE



Verpackung



Blister	
Gewicht(g)	680
Abmaße (B) x (H) x (T) (mm)	275 x 155 x 88
Umkarton	
Packs	20
Nettogewicht(kg)	24
Bruttogewicht(kg)	25.8
Abmaße (B) x (T) x (H) (cm)	56 x 47 x 35
Volumen(cbm)	0.0954

LBC-312

Lädt:

die meisten 1,2V, 3,7V
oder 7,4V Akkus*



Li-ion

Ni-MH



Beinhaltet:



Netzkabel



Spezifikationen

Ladegerät

Input: 100-240V ~ 50/60Hz 12W Max

Ladestrom:

Lithium Akkus: 3.6/3.7V 0.8A (Max)

7.2/7.4V 0.6A (Max)

Ni-MH/Ni-Cd: 2 x 1.4V = 0.7A (Max)

USB output: 5V = 0.5A

Eigenschaften:

- **Unterstützt viele Geräte** Kompatibel mit fast allen 3,7V und 7,4V Li-ion, 1,2V Ni-MH und Ni-Cd Akkus wie Digital Kameras, Camcorder, Mobiltelefone, MP3 / MP4 Player, Spielekonsolen und mehr.
- **Automatische Spannungs- / Polarisationswahl**
- **Sicher** Erkennt defekte Akkus, Sicherheitsabschaltung nach 5 Stunden bei Ni-MH / Ni-CD und nach 10 Stunden bei Li-ion Akkus.

- **Elegantes Design**
- **USB output Anschluss** für iPhone, iPod, Android Smartphone, MP3 / MP4 Players, GPS Geräte und mehr.

LED Indicator

Laden (grün)	Strom (rot)	Zustand
aus	aus	kein Strom oder defektes Netzteil
aus	an	Strom an
an	an	voll aufgeladen
blinken	an	Akku Ladevorgang
blinken	blinken	defekter Akku oder Ladevorgang durch 5 / 10 Std. Sicherheits-Timer gestoppt.

Ladezeiten:

Akkutyp	Ladezeiten (ca.)
Ni-MH AA 2700 mAh	4.5 Stunden
Ni-MH AA 2000 mAh	4 Stunden
Ni-MH AA 1500 mAh	2.5 Stunden
Ni-MH AAA 800 mAh	90 Minuten

Erhältliche Farben:

 Schwarz

BARCODE



Verpackung



Blister	
Stecker:	TUV
Gewicht(g)	179
Abmaße (B) x (H) x (T) (mm)	185 x 128 x 70
Innerer Karton	
Packs	10
Nettogewicht(kg)	1.79
Bruttogewicht(kg)	2.14
Abmaße (B) x (T) x (H) (cm)	56.5 x 20.6 x 13.5
Umkarton	
Packs	40
Nettogewicht(kg)	7.16
Bruttogewicht(kg)	10.6
Abmaße (B) x (T) x (H) (cm)	58 x 42.7 x 29
Volumen(cbm)	0.0719

LBC-313-1

Lädt:

die meisten 1,2V, 3,7V oder 7,4V Akkus*

Li-ion

Ni-MH



Beinhaltet:



Netzkabel



Spezifikationen

Input: DC 5V \approx 1A

Output: 2 x (1.4V \approx 0.7A) max (1.2V NH/NC Akkus)

4.2V \approx 0.7A max (3.7V Li-ion Akkus)

8.4V \approx 0.45A max (7.4V Li-ion Akkus)

Erhaltungsladestrom: 70mA

Eigenschaften:

- Lädt die meisten 1,2V, 3,7V and 7,4V Li-ion/Ni-MH / Ni-Cd Akkus
- Automatische Spannungs- / Polarisationswahl
- Automatische Erkennung defekter Akkus
- Sicherheitsabschaltung (5 Std. für Ni-MH /Cd oder 10 Std. für Li-ion)
- USB Output Anschluss

Laden:	grüne LED blinkt (1x / Sek.)
Voll geladen:	grüne LED bleibt an
Fehler:	Rote & Grüne LED blinkt und Laden stoppt nach wenigen Sekunden

Ladezeiten:

Akkutyp	Akkukapazität	Ladezeiten (ca.)
NP-30 3.7V Lithium-ion	1000 mAh	2 Stunden
CGR-320 7.4V Lithium-ion	3200 mAh	5.5 Stunden
14500 Lithium-ion	1000 mAh	2 Stunden
AA Ni-MH	1500 mAh	2.5 Stunden
AAA Ni-MH	800 mAh	1.5 Stunden
AA Ni-Cd	1000 mAh	2 Stunden
AAA Ni-Cd	300 mAh	30min

Erhältliche Farben:

Schwarz

BARCODE



Verpackung



Blister

Stecker:	LBC-313-1
Gewicht(g)	154
Abmaße (B) x (H) x (T) (mm)	130x188.5x62

Innerer Karton

Packs	10
Nettogewicht(kg)	1.35
Bruttogewicht(kg)	1.53
Abmaße (B)x (T) x (H) (cm)	33x25.5x14.2

Umkarton

Packs	40
Nettogewicht(kg)	6.1
Bruttogewicht(kg)	7.6
Abmaße (B)x (T) x (H) (cm)	52.5x34.5x30.5
Volumen(cbm)	0.0553

> Lithium-ion Ladegeräte

Spezifisches Ladegerät zum Laden von Lithiumakkus.
Integriert mit mehrfachem Schutz, die Ihnen Sicherheit beim Laden von Lithiumakkus bietet.

LBC-305

Lädt:

1-2 × **18650** **Li-ion**



USB Ladegerät



Spezifikationen

Input: Micro USB 5V \approx 1A
Output: 3.7V \approx 500mA
Vorsicht: Spezielles Ladegerät für
18650 Lithium-ion Akkus

Eigenschaften:

- 2 unabhängige Ladekanäle
- Geeignet für Flat Top und High Top 18650 Li-Ionen-Akkus
- Polarisierungsschutz
- Überladungsschutz
- Kurzschlusschutz
- LED Anzeige

Rot	Laden
Grün	Voll geladen

Ladezeiten:

Akkutyp	Akkukapazität	Ladezeiten (ca.)
18650 Lithium-ion	2600 mAh	6.5 Stunden
18650 Lithium-ion	2200 mAh	5.5 Stunden
18650 Lithium-ion	1800 mAh	4.5 Stunden
18650 Lithium-ion	1500 mAh	4.0 Stunden

Erhältliche Farben:

 Schwarz

BARCODE

LBC-305-DB



4 260216 456763

Verpackung



Blister

Stecker:	\
Gewicht(g)	108
Abmaße (B) x (H) x (T) (mm)	95 x 176 x 64

Innerer Karton

Packs	10
Nettogewicht(kg)	1.075
Bruttogewicht(kg)	1.425
Abmaße (B) x (T) x (H) (cm)	48.5 x 19 x 10.5

Umkarton

Packs	40
Nettogewicht(kg)	4.3
Bruttogewicht(kg)	5.8
Abmaße (B) x (T) x (H) (cm)	50.5 x 40 x 23.5
Volumen(cbm)	0.0474

CM500

Lädt:

Lithium-Ion Akkus:
26650, 26500, 22650, 18650, 18490,
17670, 17500, 17355, 16340, 14500,
10440
Ni-MH Akkus: AAA, AA, C, Sub-C

Li-ion

Ni-MH



Spezifikationen

- **4 unabhängige Ladekanäle**
- **LCD Display** mit Hintergrundbeleuchtung zeigt die einzelnen Kanäle, 3 Lademodi, Ladungsende, Ladezeit, Innenwiderstand, Kapazität, aktuelle Auswahl, Volt
- **6-facher Ladeschutz (IC Control)**
 - Δ U Prozess (Überladungsschutz)
 - Überstromschutz
 - Überhitzungsschutz
 - Batterieerkennung
 - Kurzschlusschutz
- **Entladungsfunktion**
wählbar 250mA/500mA
- **LCD Display with background lighting**

Eigenschaften:

Ladegerät Input: DC 12V
AC Adapter Input: AC 110-230V
Output: DC 12V, 2A (24W)
Ladestrom: wählbar 300mA /
500mA / 700mA / 1000mA
Sicherheitsabschaltung bei 1,48V
für NI-MH + Sub-C,
Sicherheitsabschaltung bei 4,2V
für Li-Ion
Entladestrom: 250mA oder
500mA, ist abhängig vom
Ladestrom

Verpackung



Ladezeiten:

Abhängig vom Ladestrom

Erhältliche Farben:

 Schwarz

BARCODE



Innerer Karton	
Packs	1
Bruttogewicht(kg)	573.4
Abmaße (B)x (T) x (H) (cm)	199 x 56 x 166
Umkarton	
Packs	20
Nettogewicht(kg)	9.2
Bruttogewicht(kg)	10.6
Abmaße (B)x (T) x (H) (cm)	43 x 31 x 38,5
Volumen(cbm)	0.0513

Akku Ladetabelle

Anleitung:

Die folgende Tabelle beschreibt die Ladezeiten zu den jeweiligen Camelion Ladegeräten und Akkus. Zum Beispiel: Um die Ladezeit für ein Ni-MH AA 2500mAh mit dem Ladegerät BC-0907 zu finden, suchen Sie zuerst in der Spalte der Ladegerätmodelle das Gerät BC-0907. Dann suchen Sie in der Spalte Ni-MH Akkus den Akku NH-2500. An der Stelle, wo die Spalte des Akkuladers und die Reihe des Akkus sich kreuzen, sehen Sie die Ladezeit, welche 80 Minuten beträgt.

Camelion Model	BC-0907	BC-0905A		BC-1012			BC-1010B	BC-0901	BC-1002A	BC-1001A
	DC in 12V, 1.5A	2 akkus	4 akkus	1-2 akkus	3 akkus	4 akkus				
Timer Control	1.5St	3.5St	7.0St	6.0St	9.0St	12St	NA	NA	8St	Voltage Cut Off
Ni-MH Akkus										
NH-D2500	NA	NA	NA	NA	NA	NA	NA	NA	NA	NA
NH-C2500	NA	NA	NA	NA	NA	NA	NA	NA	NA	NA
NH-AA2700	80min	3St	6St	T/C 6St	T/C 9St	T/C 12St	17St	23St	T/C 8St	T/C 12St
NH-AA2600	80min	3St	5.5St	T/C 6St	T/C 9St	T/C 12St	16St	22St	T/C 8St	T/C 12St
NH-AA2500	80min	3St	5.5St	T/C 6St	T/C 9St	T/C 12St	16St	22St	T/C 8St	T/C 12St
NH-AA2300	70min	3St	5.5St	T/C 6St	T/C 9St	T/C 12St	16St	21St	T/C 8St	T/C 12St
NH-AA2200	70min	2.5St	5St	T/C 6St	T/C 9St	T/C 12St	16St	20St	T/C 8St	T/C 12St
NH-AA2000	60min	2.5St	4.5St	T/C 6St	T/C 9St	T/C 12St	15St	19St	T/C 8St	T/C 12St
NH-AA1800	60min	2St	4.5St	6St	T/C 9St	T/C 12St	13St	17St	T/C 8St	T/C 12St
NH-AA1500	50min	2St	3.5St	4.5St	7St	10.5St	11St	14St	6St	10.5St
NH-AAA1100	90min	2St	4St	T/C 6St	T/C 9St	T/C 12St	6St	9St	T/C 8St	6St
NH-AAA1000	80min	2St	3.5St	T/C 6St	T/C 9St	T/C 12St	5.5St	9St	T/C 8St	5.5St
NH-AAA900	80min	100min	3.5St	5St	T/C 9St	12St	5St	8St	T/C 8St	5St
NH-AAA800	70min	100min	3St	5St	8.5St	11St	5St	8St	T/C 8St	5St
NH-AAA600	60min	70min	2.5St	3.5St	5.5St	7St	3.5St	5St	5St	3.5St
NH-9V250	NA	NA	NA	NA	NA	NA	22St	NA	NA	11St
NH-9V200	NA	NA	NA	NA	NA	NA	18St	NA	NA	9.5St

Camelion Model	BC-0904S	CM-9398GS	CM3298	CM9388	LBC-312	LBC-313-1
Timer Control	NA	3 / 6 / 9 / 24St	10St	NA	5h	NA
Ni-MH Akkus						
NH-D2500	NA	14St	3St	12St	NA	NA
NH-C2500	NA	14St	3St	12St	NA	NA
NH-AA2700	22St	14St	3St	12St	4.5St	4.5St
NH-AA2600	20St	13St	3St	12St	4St	4St
NH-AA2500	20St	13St	3St	12St	4St	4St
NH-AA2300	19St	12St	2.5St	10St	4St	4St
NH-AA2200	19St	12St	2.5St	10St	3.5St	3.5St
NH-AA2000	17St	10.5St	2.5St	9.5St	3.5St	3.5St
NH-AA1800	16St	10St	2St	8.5St	3St	3St
NH-AA1500	13St	8.5St	2St	7St	2.5St	2.5St
NH-AAA1100	17St	4.5St	2.5St	4St	100min	100min
NH-AAA1000	16St	4.5St	2St	3.5St	100min	100min
NH-AAA900	15St	3.5St	2St	3.5St	90min	90min
NH-AAA800	14St	3.5St	2St	3St	90min	90min
NH-AAA600	10.5St	3St	1.5St	2.5St	1St	1St
NH-9V250	11St	11St	4.5St	27St	NA	NA
NH-9V200	9.5St	9.5St	3.5St	22St	NA	NA

Bemerkungen:

NA – nicht anwendbar.

T/C: Ladegerät hat Sicherheitsabschaltung. Dies ist eine Abschaltzeit, ob der Akku vollgeladen ist oder nicht. Alle Daten basieren auf den neuesten Camelion Labortests. Ladezeiten dürfen variieren, je nach Temperatur, Produktalter, Spannung und anderer Zustände bzw. Faktoren.

Dieses Datenblatt ist für Kunden eine Auskunft und hilft das gewünschte Produkt zu finden.

Die Inhalte stellen keine Garantie dar.

Für Informationen zu spezifischen Camelion Produkten besuchen Sie bitte unsere Website www.camelion.com oder kontaktieren Sie uns direkt auf info@camelion.com.

Power Banks USB Steckeradapter



> PowerBanks

Camelion Powerbanks bieten schnelle, einfache und verlässlichen Strom für Ihre mobilen Geräte. Integriert mit hochwertigen Akkus, garantieren wir Ihnen ein Produkt mit langer Lebensdauer und voll im Einklang zu den internationalen Sicherheitsstandards.

Camelion®

PS675



PS675-DB



4 260216 456282

Zubehör:
USB Kabel
(L:30cm)



LED Status (● AN ○ AUS)	Kapazität
● ● ● ●	76%-100%
○ ● ● ●	51%-75%
○ ○ ● ●	26%-50%
○ ○ ○ ●	<25%

Eigenschaften

- LED Taschenlampenfunktion
- 2,1A Ausgang
- Kompatibel mit den meisten mobilen Geräten
- Kurzschluss-, Tiefenentladungs-, Überladungs-, und Überspannungsschutz
- speziell gestaltetes Gehäuse - einzigartig und elegant

Spezifikationen

Akkukapazität 6.000mAh Li-polymer Akku

Eingang: Micro USB 5V \pm 2A

Ausgang: 5V \pm 2.1A

Verpackung

Blister	Gewicht(g)	180
	Abmaße (W) x (H) x (D)(mm)	135 x 230 x 36
Innerer Karton	Packs / Innerer karton	12
	Nettogewicht(kg)	/
	Bruttogewicht(kg)	/
	Abmaße (L)x (W) x (H) (cm)	/
Umkarton	Packs / karton	48
	Nettogewicht(kg)	/
	Bruttogewicht(kg)	/
	Abmaße (L)x (W) x (H) (cm)	55 x 44.5 x 25.5
	Volumen(cbm)	0.0625

PS679



PS679-160CB



4 260216 456817

Zubehör:
USB Kabel
(L:30cm)



LED Status (● AN ○ AUS)	Kapazität
● ● ● ●	76%-100%
○ ● ● ●	51%-75%
○ ○ ● ●	26%-50%
○ ○ ○ ●	<25%

Eigenschaften

- Kompatibel mit den meisten mobilen Geräten
- Auto An / Aus-Funktion
- Mehrfache Sicherheit (Kurzschluss, Tiefenentladung, Überladung, Überspannung)

Spezifikationen

Akkukapazität 16.000mAh Li-polymer Akku

Eingang: Micro USB 5V \pm 2A

Ausgang: 5V \pm 2.1A

Verpackung

Box	Gewicht(g)	440
	Abmaße (W) x (H) x (D)(mm)	105 x 189 x 30
Innerer Karton	Packs / Innerer karton	6
	Nettogewicht(kg)	/
	Bruttogewicht(kg)	/
	Abmaße (L)x (W) x (H) (cm)	21.4x19x13.2
Umkarton	Packs / karton	24
	Nettogewicht(kg)	10.5
	Bruttogewicht(kg)	11.4
	Abmaße (L)x (W) x (H) (cm)	40.2 x 23.2 x 28.9
	Volumen(cbm)	0.027

AD568

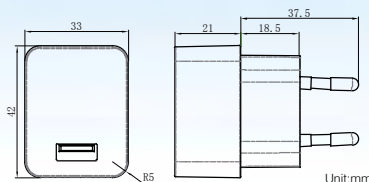

AD568-DB



Eigenschaften

- 1A Stromversorgung für Tablets und mobile Geräte
- Verwenden Sie jedes beliebige USB Kabel
- Überladungs-, Überspannungs- und Kurzschlusschutz
- Universalspannung 100 - 240V AC

Spezifikationen

Eingang: 100-240V~50/60Hz 150mA

Ausgang: 5V = 1A

Verpackung

Blister	Stecker	TUV
	Gewicht(g)	64
	Abmaße (W) x (H) x (D)(mm)	107x171x65
Innerer Karton	Packs / Innerer karton	24
	Nettogewicht(kg)	0.86
	Bruttogewicht(kg)	1.7
	Abmaße (L)x (W) x (H) (cm)	58.5x40.5x11.7
Umkarton	Packs / karton	48
	Nettogewicht(kg)	1.7
	Bruttogewicht(kg)	3.8
	Abmaße (L)x (W) x (H) (cm)	60x41.5x25.5
	Volume(cbm)	0.0635

AD569

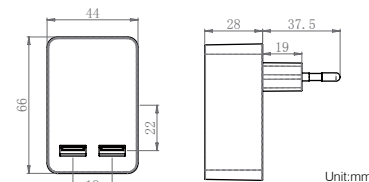

AD569-DB



Eigenschaften

- 3,4A Ladestrom, USB für schnellstmögliches Laden.
- Zweifacher USB Anschluss ermöglicht das Laden von zwei Geräten gleichzeitig
- Direkte Stromversorgung für Tablets und anderen mobilen Geräten
- Überspannungs-, Überhitzungs- und Kurzschlusschutz
- Weltweite Nutzung möglich, Steckertypen sind je nach Landesforderung erhältlich

Spezifikationen

Eingang: 100-240V~50/60Hz 21W max

Ausgang: 5V = 3.4A (2.4A+1A)

Verpackung

Blister	Stecker	TUV	UL
	Gewicht(g)	116	112
	Abmaße (W) x (H) x (D)(mm)	107 x 171 x 70	107 x 171 x 67
Innerer Karton	Packs / Innerer karton	24	24
	Nettogewicht(kg)	2.8	2.7
	Bruttogewicht(kg)	3.1	3.0
	Abmaße (L)x (W) x (H) (cm)	44.4 x 19.9 x 21.6	44.4 x 19.9 x 21.6
Umkarton	Packs / karton	48	48
	Nettogewicht(kg)	5.7	5.4
	Bruttogewicht(kg)	6.2	5.9
	Abmaße (L)x (W) x (H) (cm)	45.6 x 41.3 x 23.1	45.6 x 41.3 x 23.1
	Volume(cbm)	0.0435	0.0435

> USB Steckeradapter

Camelion USB Stecker Adapter bieten Ihnen schnelle, zuverlässige und effiziente Stromversorgung für zu Hause, im Büro oder auf Reisen. Es gibt sie in verschiedenen Größen und alle Arbeiten mit Universalspannung.

Camelion®

DD801

Lädt **2 USB**
Geräte zur gleichen Zeit!

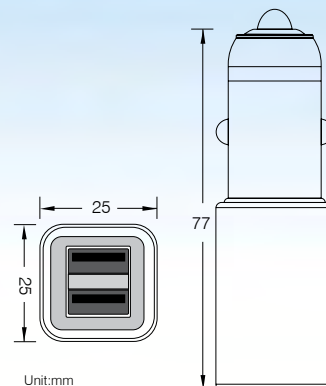

Eigenschaften

- **KFZ-Ladeadapter mit doppelten USB Anschluss** Bis zu 5V, 2100mA direkte Stromquelle für iPad, iPod Geräte, iPhone, Mobiltelefone, PSP, Blackberry, Digitalkameras und andere mobile Geräte. Einfach in Ihren KFZ Zigarettenanzünder stecken oder in eine Steckdose, einschalten und abspielen.
- **Kurzschlusschutz** Im Falle eines Kurzschluss ist der Ladeadapter und die mobilen Geräte vor Beschädigungen geschützt.

Spezifikationen

Eingang: 12 - 24V $\overline{\text{---}}$

Ausgang: 5V $\overline{\text{---}}$ 2.1A bei Nutzung von 1 USB Anschluss
5V $\overline{\text{---}}$ 1A bei Nutzung von 2 USB Anschlüssen

Verpackung

Blister	Stecker	/
	Gewicht(g)	66
	Abmaße (W) x (H) x (D)(mm)	133 x 220 x 69
Innerer Karton	Packs / Innerer karton	18
	Nettogewicht(kg)	1.2
	Bruttogewicht(kg)	1.95
	Abmaße (L)x (W) x (H) (cm)	41.5 x 30 x 23.5
Umkarton	Packs / karton	36
	Nettogewicht(kg)	2.4
	Bruttogewicht(kg)	3.9
	Abmaße (L)x (W) x (H) (cm)	48.5 x 31.5 x 43.5
	Volume(cbm)	0.0665

DD802

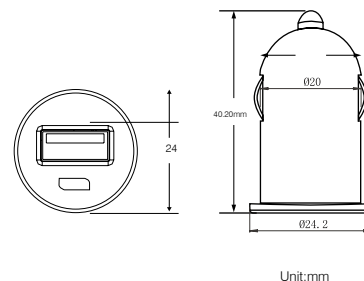

Eigenschaften

- **KFZ-Ladegerät mit USB Anschluss** Bis zu 5V, 1000mA direkte Stromquelle für iPad, iPod Geräte, iPhone, Mobiltelefone, PSP, Blackberry, Digitalkameras und andere Musikgeräte. Einfach in Ihren KFZ Zigarettenanzünder stecken oder in eine Steckdose, einschalten und abspielen.
- **Klein und tragbar** Das Gerät ist kleiner als ein Standard KFZ-Ladegerät und kann leicht mitgeführt werden.
- **Kurzschlusschutz** Im Falle eines Kurzschluss ist das Ladegerät und die mobilen Geräte vor Beschädigungen geschützt.

Spezifikationen

Eingang: 12-24V $\overline{\text{---}}$

Ausgang: 5V $\overline{\text{---}}$ 1A

Verpackung

Blister	Stecker	/
	Gewicht(g)	56.3
	Abmaße (W) x (H) x (D)(mm)	112x184x57
Innerer Karton	Packs / Innerer karton	24
	Nettogewicht(kg)	/
	Bruttogewicht(kg)	/
	Abmaße (L)x (W) x (H) (cm)	23.1x19.1x12.4
Umkarton	Packs / karton	48
	Nettogewicht(kg)	2.7
	Bruttogewicht(kg)	3.9
	Abmaße (L)x (W) x (H) (cm)	39.6x24.5x40
	Volume(cbm)	0.0388

DD823



DD823-DB

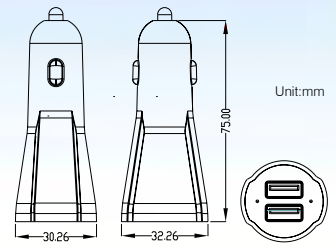

Unit:mm

Eigenschaften

- Kompatibel mit den meisten mobilen Geräten
- Zweifacher USB Anschluss
- max. 4.8A schnelles Aufladen
- Kurzschlusschutz

Spezifikationen

Eingang: 12V - 24V \equiv

Ausgang: 5V \equiv 2.4A+2.4A

Verpackung

Blister	Gewicht(g)	65
	Abmaße (W) x (H) x (D)(mm)	133 x 220 x 35
Innerer Karton	Packs / Innerer karton	18
	Nettogewicht(kg)	/
	Bruttogewicht(kg)	/
	Abmaße (L)x (W) x (H) (cm)	41.5 x 30 x 23.5
Umkarton	Packs / karton	36
	Nettogewicht(kg)	2.4
	Bruttogewicht(kg)	3.9
	Abmaße (L)x (W) x (H) (cm)	48.5 x 42.5 x 25
	Volume(cbm)	0.0516

AD568+DD811+CDC015

3in1 USB Ladeset



AD568+DD811+CDC015-CB



Eigenschaften

- | | | |
|--|--|--|
| <p>USB Steckeradapter</p> <ul style="list-style-type: none"> • 1A direkte Stromversorgung für mobile Geräte • Kompatibel mit jedem USB-Kabel • Überstrom-, Überspannungs- und Kurzschlusschutz • Universalspannung 100-240V | <p>USB Car Charger</p> <ul style="list-style-type: none"> • Kompatibel mit den meisten mobilen Geräten • Kurzschlusschutz | <p>2in1 USB Ladekabel</p> <ul style="list-style-type: none"> • Mikro USB + 8pin Lightning • Strapazierfähiges Nylonkabel • Dauerhaft Biegsam • ein-/ausstecken (bis zu 3000 Mal) • Kompatibel mit 2,4A Schnell Ladegeräten |
|--|--|--|

Spezifikationen

USB Steckeradapter

Eingang: 100-240V~50/60Hz 150A

Ausgang: 5V \equiv 1.0A

USB Car Charger

Eingang: 12 - 24V \equiv 1.3A (max)

Ausgang: 5V \equiv 2.1A

Verpackung

Box	Plug:	UL/UK/TUV/SAA
	Gewicht(g)	105
	Abmaße (W) x (H) x (D)(mm)	91 x 122 x 37
Innerer Karton	Packs / Innerer karton	10
	Nettogewicht(kg)	/
	Bruttogewicht(kg)	/
	Abmaße (L)x (W) x (H) (cm)	20 x 19.5 x 12.8
Umkarton	Packs / karton	40
	Nettogewicht(kg)	5.3
	Bruttogewicht(kg)	5.6
	Abmaße (L)x (W) x (H) (cm)	42.5 x 22 x 28.5
	Volume(cbm)	0.0752

Anwendungstabelle

bestens geeignet gut geeignet nicht geeignet

USB-fähige Geräte		Power Bank		USB Steckeradapter				
		PS675	PS679	AD568	AD569	DD801	DD802	DD823
Mobilfunk- geräte	iPhone 4/4S/5	✓	✓	✓	✓	✓	✓	✓
	iPod®	✓	✓	✓	✓	✓	✓	✓
	iPad®	✓	✓	✓	✓	✓	✓	✓
	Samsung	✓	✓	✓	✓	✓	✓	✓
	Sony	✓	✓	✓	✓	✓	✓	✓
	HTC	✓	✓	✓	✓	✓	✓	✓
	Blackberry®	✓	✓	✓	✓	✓	✓	✓
	Nokia	✓	✓	✓	✓	✓	✓	✓
	LG	✓	✓	✓	✓	✓	✓	✓
	Sharp	✓	✓	✓	✓	✓	✓	✓
	Motorola	✓	✓	✓	✓	✓	✓	✓
	Smart Phone	✓	✓	✓	✓	✓	✓	✓
	Portable Gaming Devices	✓	✓	✓	✓	✓	✓	✓
	Tablet	✓	✓	✓	✓	✓	✓	✓
Andere Geräte	MP3/MP4/MP5	✓	✓	✓	✓	✓	✓	✓
	Loudspeaker	✓	✓	✓	✓	✓	✓	✓
	AM/FMRadio	✓	✓	✓	✓	✓	✓	✓
	Digital Camera	✓	✓	✓	✓	✓	✓	✓
	GPS	✓	✓	✓	✓	✓	✓	✓
	USB battery charger	✓	✓	✓	✓	✓	✓	✓
	Electronic shaver	✓	✓	✓	✓	✓	✓	✓

- Bitte beachten Sie:**
1. Die Kapazität eines iPad Akkus muss nicht unter 5 % sein.
 2. Anwendbar nur für USB 2.0 und niedrigere Versionen.
 3. Camelion übernimmt keine Verantwortung für Störfälle/Unfälle gleich welcher Art durch Anwendungen auf Grund dieser Informationen. Es handelt sich hier lediglich um Empfehlungen.

Batteriebetriebene Taschenlampen



SuperBright™ Taschenlampen

LED Taschenlampen für zu Hause oder Freizeit



Multi-Head Klassische LED Taschenlampen

- **Kleeblatt Reflektor System** für maximalen Fokus und Lichtintensität.
- **Energiesparende LEDs**, bis zu 5-mal heller und 8-mal effizienter als herkömmliche Kryptonbirnen*
- **Lange Lebensdauer** Bis zu 180 Stunden dauerhafte Beleuchtung*
- **Bis zu 100.000 Stunden LED Lebensdauer**
- **Handlicher Griff** mit Haken, Anti-Roll Design

*Camelion Labor Tests 2009. Leistung ist abhängig von Batterie, Temperatur Lichtverhältnisse.

Bestens für:

- Innen- und / oder Außenbereich Nutzung
- Praktisch für Camping, Reisen und Angeln
- Nutzung im Haushalt, Hundespaziergang



6 LED



FL6L2D2R20P



Spezifikationen

Produktabbildung	Name	Artikel	LEDs	LED Typ	Lumen	Batterie-modell	Material	erhältliche Farben	Wasser-resistent
	Multi-Head LED Classic Taschenlampe	FL6L2D	6	Superbright LED	12lm	2 x D	Kunststoff	gelb	✓

Verpackungsdetails

Verpackungsabbildung	Name	Artikel	Verpackungstyp	beinhaltete Batterien	Blister/Boxdetails				Umkartondetails						
					Abmaße (mm)			Nettogewicht (g)	Verpackungseinheiten	Abmaße (cm)			Volumen (cbm)	Bruttogewicht (Kg)	Nettogewicht (kg)
					L Länge	B Breite	T Tiefe			L Länge	B Breite	T Tiefe			
	Multi-Head LED Classic Taschenlampe	FL6L2D2R20P	Blister Pack	2 x R20P	264	144	40	285	24	55.5	42.5	18.5	0.0436	8.3	7.4

SuperBright™ Taschenlampen

Haushaltstaschenlampen für den täglichen Gebrauch









Klassische Taschenlampe

- Super helle und auswechselbare LEDs
- 35 Lumen
- Lange Batterielaufzeit
- in verschiedenen Farben erhältlich

Bestens für:

- Innen- & Außengebrauch
- Handlich für Camping, Reisen, Angeln
- Gebrauch im Haushalt

			Spezifikationen					
Produktabbildung	Name	Artikel	Birnentyp	Lumen	Batterie-modell	Material	erhältliche Farben	Wasser-resistent
	Klassische Taschenlampen	FL1L2D	LED	35lm	2 x D	Kunststoff	 rot gelb blau schwarz	✗
	Klassische Taschenlampen	FL1L2C	LED	35lm	2 x C	Kunststoff	 rot gelb blau schwarz	✗
	Klassische Taschenlampen	FL1L2AA	LED	35lm	2 x AA	Kunststoff	 rot gelb blau schwarz	✗

FL1L2D

 **1 LED**



FL1L2D2R20P



FL1L2DD12



FL1L2C

 **1 LED**



FL1L2C2R14P



FL1L2AA

 **1 LED**







FL1L2AA2R6P



FL1L2AAD24



Verpackungsdetails

Verpackungsab- bildung	Name	Artikel	Verpackung- styp	beinhaltete Batterien	Blister/Boxdetails			Netto- gewicht (g)	Verpackung- seinheiten	Umkartondetails			Brutto- gewicht (Kg)	Netto- gewicht (kg)	
					Abmaße (mm)					Abmaße (cm)					Volumen (cbm)
					L Länge	B Breite	T Tiefe			L Länge	B Breite	T Tiefe			
	Klassische Taschenlampen	FL1L2DB2R20P	Blister Pack	2 x R20P	292	158	64	312	24	46	31.5	31	0.0449	9.0	7.5
		FL1L2DD12	Display box	—	250	188	195	1332	4	51.5	40	21.5	0.0443	7.0	5.3
	Klassische Taschenlampen	FL1L2CB2R14P	Blister Pack	2 x R14P	240	131	50	170	24	47	26	20	0.0244	4.1	5.0
	Klassische Taschenlampen	FL1L2AAB2R6P	Blister Pack	2 x R6P	211	99	38	84	60	40	30	23	0.0276	6.0	5.3
		FL1L2AAD24	Display box	—	230	154	150	1116	8	48	33	32.5	0.0515	10.5	8.9

SuperBright™ Handscheinwerfer

LED Handscheinwerfer geeignet für zu Hause und Freizeit



Multi-Head LED Handscheinwerfer

- **Leistungsstark** Lichtentfernung bis zu 150m*
- **Kleeblatt Reflektor System** für maximalen Fokus und Intensität
- **Energiesparende LED** bis zu 5 mal heller, 8 mal effizienter als herkömmliche Kryptonbirnen*
- **Lange Lebensdauer** bis zu 500 Stunden beständiges Licht*
- **Bis zu 100.000 Stunden LED Lebensdauer**
- **Einfache Handhabung** mit antirutschfestem Design

*Camelion Labortests 2009: Leistung gemäß Batterie (Alkaline), Temperatur und Lichtverhältnissen der Umgebung.

Bestens für:

- Innen & Außengebrauch
- Militär, Wachschutz
- Werkstatt, Garage, Auto Service
- Handlich für Camping, Reisen, Angeln

Produktabbildung	Name	Artikel	Spezifikationen						
			LEDs	LED Typ	Lumen	Batteriemodell	Material	erhältliche Farben	Wasserresistent
	Multi-Head LED Search lamps	FL-16LED	16	Super Bright LED	32lm	4 x D/ 1 x 4R25	Plastic	Yellow	✓
	Multi-Head LED Search lamps	FL-9LED	9	Super Bright LED	18lm	4 x AA	Plastic	Yellow	✓
	LED Search lamps	CM25L	1	Super Bright LED	45lm	1 x 4R25	Plastic	Yellow	/

FL-16LED

 **16LED**

Bis zu 500 Std
durchgehend
einsatzbereit



CE

FL-16LED-4R20PCB



FL-9LED

 **9LED**

Bis zu 150 Std
durchgehend
einsatzbereit



CE

FL-9LED-4R6P



CM25L

 **1LED**

Up to 100 Hrs
Continuous
use





CE

CM25L-4R25



Verpackungsdetails

Verpackungsab- bildung	Name	Artikel	Verpackung- styp	beinhaltete Batterien	Blister/Boxdetails				Umkartondetails						
					Abmaße (mm)			Netto- gewicht (g)	Verpackung- seinheiten	Abmaße (cm)			Volumen (cbm)	Brutto- gewicht (Kg)	Netto- gewicht (kg)
					L Länge	B Breite	T Tiefe			L Länge	B Breite	T Tiefe			
	Multi-Head LED Handscheinwerfer	FL-16LED- 4R20PCB	Box	—	250	123	135	708	12	52	39	30	0.0552	12	11
	Multi-Head LED Handscheinwerfer	FL-9LED-4R6P	Shrink pack	4 x R6P	100	146	110	278	36	59	54	24	0.0765	14.0	10
	LED Search lamps	CM25L-4R25	Shrink pack	1 x 4R25	255	110	115	800	12	53	32.5	28.5	0.0491	12.5	9.6

LED Schlüsselanhänger



LED Schlüsselanhänger

- Gummiertes und langlebiges Gehäuse
- Langes Dauerlicht bis zu 14 Stunden
- Eingebaute Super Bright LED

Bestens für:
Reisen, Wandern, Camping

Spezifikationen							
Modell	LEDs	LED Typ	Lumen	Batterie Modell	Material	erhältliche Farben	Wasser-resistent (Y/N)
SL3013	1	weiß	5lm	3 x LR44	Kunststoff	<div style="display: flex; flex-direction: column; gap: 5px;"> <div>■ gelb</div> <div>■ rot</div> <div>■ grün</div> <div>■ blau</div> </div>	N

SL3013



LED

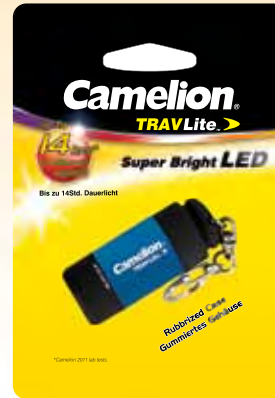
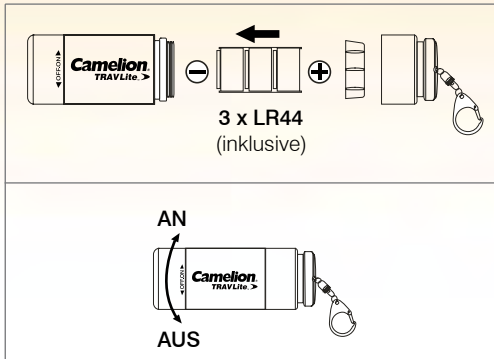

SL3013-3LR44BP



SL3013-3LR44-PB36



Verpackungsdetails

Name	Artikel	Verpackungs- styp	beinhaltete Batterien	Blister/Boxdetails				Umkartondetails						
				Abmaße (mm)			Netto- gewicht (g)	Verpackung- seinheiten	Abmaße (cm)			Volumen (cbm)	Brutto- gewicht (Kg)	Netto- gewicht (kg)
				L Länge	B Breite	T Tiefe			L Länge	B Breite	T Tiefe			
SL3013-3LR44BP	SL3013-3LR44BP	Blister Pack	3x LR44	167	155	103	26	192	32.5	31.5	45.5	0.0466	7.7	5.0
SL3013-3LR44-PB36	SL3013-3LR44-PB36	Display Box	3x LR44	395	165	225	850	12	41.5	24.5	34.5	0.0347	11.0	10.2

TRAVLite™ Taschenlampen

Ideales Licht für Outdoor-Aktivitäten



Hosentaschen LED Taschenlampe

- **Ultra Schock resistent** TPE Gehäuse bis zu 3m Fallhöhe.
- **Bis zu 40 Stunden Licht.***
- **Wasserresistenter und wetterfester O Ring und versiegelte Schaltkonstruktion.**
- **Hoch Lumen LED** außergewöhnliche Beleuchtung, hohe Energieeffizienz und langlebig.
- **Schmales, kleines, handliches, tragbares Design** einschließlich Handgelenkgurt, ideal für Reisen.
- **Benötigt herkömmliche AAA Batterien.**

Bestens für:

Camping, Freizeitaktivitäten im Freien, Kindergarten

LED Gummi Taschenlampen

- **Schwerbelastbares gummiertes Gehäuse**
- **Stoßfest bis zu 2m Fallhöhe**
- **Wasserresistent (IPX7*)**
- **Bruchsichere optische Linsen**
- **Rutschfester Griff** Öl / Schmiere Resistenter Griff mit Druckknopfschalter und Gurt
- **LED mit bis zu 100.000 Stunden Lebensdauer**
- **Helligkeitsverstärkendes optisches Hohlraum Design**

Bestens für:

Reisen, Wandern, Camping, Angeln

*Im Camelion Labortest 2009 wurden 3 Camelion Alkaline AAA Batterien verwendet; die LED Helligkeit schwächt sich ab, wenn die Kraft der Batterien schwach wird.

		Spezifikationen						
Name	Artikel	LEDs	LED Typ	Lumen	Batterie-modell	Material	erhältliche Farben	Wasser-resistent
Hosentaschen LED Taschenlampe	HP7011	1	Superbright LED	40lm	3 x AAA	Kunststoff	rot grün	✓
Gummi Taschenlampe	PT1L2D	1	Superbright LED	45lm	2 x D	Gummi	rot blau	✓
Gummi Taschenlampe	PT1L2AA	1	Superbright LED	45lm	2 x AA	Gummi	rot blau	✓

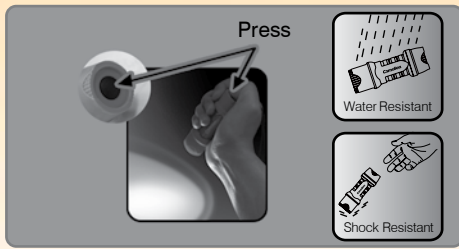

HP7011



HP7011-3R03BP



PT1L2D



PT1L2D-2R20PBP

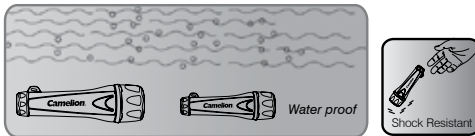

PT1L2AA



PT1L2AA-2R6PBP



Verpackungsdetails

Name	Artikel	Verpackungs- styp	beinhaltete Batterien	Blister/Boxdetails				Umkartondetails						
				Abmaße (mm)			Netto- gewicht (g)	Verpackung- seinheiten	Abmaße (cm)			Volumen (cbm)	Brutto- gewicht (Kg)	Netto- gewicht (kg)
				L Länge	B Breite	T Tiefe			L Länge	B Breite	T Tiefe			
Hosentaschen LED Taschenlampe	HP7011- 3R03BP	Doppelblister	3 x R03P	110	190	40	96.5	48	51.5	21.5	26.5	0.0294	6.4	4.7
	HP7011D24	Display Box	—	303	206	110	1496	4	46	34	25	0.0391	7.1	6.0
Gummi Taschenlampe	PT1L2D- 2R20PBP	Doppelblister	2 x R20P	305	175	70	446	24	50.5	45	33	0.0750	11.7	10.7
Gummi Taschenlampe	PT1L2AA- 2R6PBP	Doppelblister	2 x R6P	248	120	50	161	48	49.5	36	33	0.0588	8.7	7.7

Penlight Taschenlampen

Ein elegantes Geschenk und ein handliches Werkzeug



- Kraftvoller Punktstrahler
- Langlebiges Flugzeug Aluminium
- Starker Taschenclip
- Druckknopfschalter

geeignet für

- nützliches Werkzeug für Ärzte
- elegantes, modisches Geschenk
- hilfreiches Anzeigeelement während Präsentationen und Vorträgen



1 Vakuum



DL2AAAS



4 260033 1154347

Spezifikationen

Produktabbildung	Name	Artikel	Birnentyp	Spannung/ Ampere	Batterie modell	Material	erhältliche Farben	Wasser-resistent
	Penlight Taschenlampe	DL2AAAS	Vakuum	2.2V/250mA	2AAA	Flugzeug-Aluminium	<input type="checkbox"/> silber	<input checked="" type="checkbox"/>

Verpackungsdetails

Verpackungsabbildung	Name	Artikel	Verpackungstyp	beinhaltete Batterien	Blister/Boxdetails				Umkartondetails						
					Abmaße (mm)			Nettogewicht (g)	Verpackungseinheiten	Abmaße (cm)			Volumen (cbm)	Bruttogewicht (Kg)	Nettogewicht (kg)
					L Länge	B Breite	T Tiefe			L Länge	B Breite	T Tiefe			
	Penlight Taschenlampe	DL2AAAS	Blister Pack	2 x R03P	200	155	115	56	100	48.5	39.0	25.0	0.0479	5.6	7.0

Ideales Licht am Arbeitsplatz

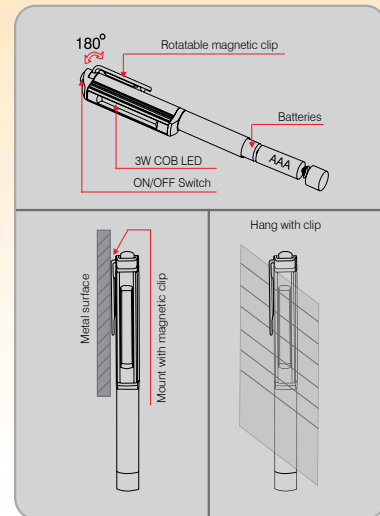

LED Inspektionsleuchte

- Leistungsstarke 3W COB Beleuchtung
- Langlebiges CNC-bearbeitetes legiertes Aluminiumgehäuse
- Drehbarer Magnet Clip
- Nicht-auswechselbare LED mit bis zu 50.000 Stunden Lebensdauer



T11-3R03PD12



4 260216 456244

Spezifikationen

Modell	LEDs	LED Typ	Lumen	Batteriemodell	Material	erhältliche Farben	Wasser-resistent (Y/N)
T11	1	3W COB LED	200lm	3 x AAA	Aluminium	<div style="display: flex; flex-direction: column; gap: 5px;"> <div>■ Blau</div> <div>■ Rot</div> <div>■ Silber</div> </div>	N

Verpackungsdetails

Artikel	Verpackungstyp	beinhaltete Batterien	Blister/Boxdetails				Umkartondetails						
			Abmaße (mm)			Nettogewicht (g)	Verpackungseinheiten	Abmaße (cm)			Volumen (cbm)	Bruttogewicht (Kg)	Nettogewicht (kg)
			L Länge	B Breite	T Tiefe			L Länge	B Breite	T Tiefe			
T11-3R03PD12	Display Box	3 x R03P	202	125	40	94	48	58	36.5	22.5	0.0477	5.5	4.5



CT-Serie LED Taschenlampen



Hochwertige Aluminium-Taschenlampen mit maximaler Ausleuchtung

- Hochleistungschip SMD-Technologie
- Unzerbrechliche eloxierte Aluminium Legierung
- Ultrahohe Leuchtkraft

Bestens für:
 fachgerechte Anforderungen bei:
 Sicherheits- und Rettungsdiensten, Polizei, Militär u.a.
 Freizeitaktivitäten aller Art

Spezifikationen									
Produktabbildung	Name	Artikel	LEDs	LED Typ	Lumen	Batterie-modell	Material	erhältliche Farben	Wasser-resistent
	9 LED Taschenlampe	CT4004	9	LED Technologie	120lm	3 x AAA	Aluminium	<div style="display: flex; align-items: center;"> <div style="width: 10px; height: 10px; background-color: black; margin-right: 5px;"></div> schwarz <div style="width: 10px; height: 10px; background-color: silver; margin-left: 10px; margin-right: 5px;"></div> silber </div>	✗
	30 LED Taschenlampe	CT4005	30	LED Technologie	120lm	2 x D	Aluminium	<div style="display: flex; align-items: center;"> <div style="width: 10px; height: 10px; background-color: black; margin-right: 5px;"></div> schwarz </div>	✗
	3 Watt Taschenlampe	CT4010	1	Hochleistungschip SMD Technologie	130lm	3 x AAA	Aluminium	<div style="display: flex; align-items: center;"> <div style="width: 10px; height: 10px; background-color: silver; margin-right: 5px;"></div> silber </div>	✗

CT4004

 **9 LED**



CE



CT4004

 4 260030 255733

CT4005

 **30 LED**



CE



CT4005

 4 260030 255740

CT4010

 **3 Watt LED**





CE



CT4010

 4 260030 255795

Verpackungsdetails

Verpackungsab- bildung	Name	Artikel	Verpackungs- styp	beinhaltete Batterien	Blister/Boxdetails				Umkartondetails						
					Abmaße (mm)			Netto- gewicht (g)	Verpackungs- einheiten	Abmaße (cm)			Volumen (cbm)	Brutto- gewicht (Kg)	Netto- gewicht (Kg)
					L Länge	B Breite	T Tiefe			L Länge	B Breite	T Tiefe			
	9 LED Taschenlampe	CT4004	Doppel- blister	3 x R03	244	123	40	149.9	120	51	38	56	0.1085	20	19
	30 LED Taschenlampe	CT4005	Doppel- blister	—	345	180	60	397.3	40	74	45	30.5	0.1016	17	16
	3 Watt Taschenlampe	CT4010	Doppel- blister	3 x LR03	242	121	35	153.8	120	51	38	56	0.1085	20	19

CT-Serie **LED Taschenlampen**

Beste Beleuchtung für den Außenbereich



LED Laternen

Eigenschaften	Solar Laterne	1 Watt Tischlaterne
Beleuchtungsmodus	100 % / 50 %	100 % / 50 % / Blinken
Leuchtdauer	3 Std.	17 Std.
Anwendungen	Außenbereich, Camping, Reisen	

- Effektive Beleuchtung
- LED Technologie bietet hervorragende Beleuchtung und hohe Effizienz
- Handlicher Griff, justierbarer Griff mit Haken
- Gummierter Druckschalter

3 Watt Kopflampe

- Hochleistungschip SMD-Technologie
- Niedriger Stromverbrauch
- Ultrahohe Leuchtkraft
- 3 verschiedene LED Modus

Bestens für:

Camping, Außenbereich, Höhlenwandern

Spezifikationen

Produktabbildung	Name	Artikel	LEDs	LED Typ	Lumen	Batterie-modell	Material	erhältliche Farben	Wasser-resistent
	36 LED Solar Laterne	Solar Laterne	36	LED Technologie	bis zu 100lm	4 x D / eingebaut-tes Akku	Gummiertes Aluminium	■ schwarz	✗
	1 Watt LED Tischlaterne	CT4008	1	Hochleistungschip SMD Technologie	70lm	4 x AA	Gummiertes Aluminium	■ schwarz	✗
	3 Watt LED Kopflampe	CT4007	1	Hochleistungschip SMD Technologie	130lm	3 x AAA	Kunststoff	■ schwarz	✗

Solar Laterne

36 LED



CT4008

1 Watt Tischlaterne



CT4007

3 Watt Kopflampe



Verpackungsdetails

Verpackungsabbildung	Name	Artikel	Verpackungstyp	beinhaltete Batterien	Blister/Boxdetails			Nettogewicht (g)	Verpackungseinheiten	Umkartondetails					
					Abmaße (mm)					Abmaße (cm)			Volumen (cbm)	Bruttogewicht (Kg)	Nettogewicht (kg)
					L Länge	B Breite	T Tiefe			L Länge	B Breite	T Tiefe			
	36 LED Solar Laterne	Solar Laterne	Box	_____	265	140	140	681.7	24	57.5	43.5	37.5	0.0938	23	20
	1 Watt LED Tischlaterne	CT4008	Doppelblister	_____	242	123	50	164.7	100	57	54.5	36	0.1119	21.5	18.5
	3 Watt LED Kopflampe	CT4007	Doppelblister	3 x LR03	245	125	100	150.5	100	52	38	58.5	0.1156	15.5	13.5

Werkstattleuchte + Multi Light 2 in 1

Ideales Licht am Arbeitsplatz





Werkstattleuchte + Multi Light 2 in 1

- Hervorragende Beleuchtung durch 3W COB LED
(in the english catalogue is a mistake, not "my", but "by")
- starker Magnetknopf und 360° schwenkbarer Haken
- gummiertes und langlebiges ABS Gehäuse für mehr Komfort

Bestens für:

Beruf, zu Hause und Büro

Spezifikationen

Modell	LED Typ	Lumen	Batteriemodell	Material	erhältliche Farben	Wasser-resistent (Y/N)
SL5240N	3W COB LED	220lm	3 x AA	ABS Kunststoff	 Schwarz + Orange	N
SL7280N	3W COB LED	200lm	3 x AAA	ABS Kunststoff	 Schwarz + Orange	N

Werkstattleuchte



SL5240N
3W COB LED



Multi Light 2 in 1



SL7280N
3W COB LED



Artikel	Verpackungstyp	beinhaltete Batterien	Verpackungsdetails										
			Blister/Boxdetails				Umkartondetails						
			Abmaße (mm)			Nettogewicht (g)	Verpackungseinheiten	Abmaße (cm)			Volumen (cbm)	Bruttogewicht (Kg)	Nettogewicht (kg)
L Länge	B Breite	T Tiefe	L Länge	B Breite	T Tiefe								
SL5240N-3R6PD12	Display Box	3x R6P	202	227	210	1750	4	49	24	46	0.0541	9.0	7.0
SL7280N-3R03PD12	Display Box	3x R03P	143	232	108	1250	8	62.5	34	22.5	0.0479	11.5	10.5

3W COB LED



Eigenschaften

- Leistungsstarke 3W COB LED-Beleuchtung
- 360° drehbarer Standfuß für unterschiedliche Beleuchtungsrichtungen
- Starker Magnetknopf zum Befestigen an metallischen Oberflächen
- Nicht-auswechselbare LED

Spezifikationen

Stromquelle: 4 x AAA Batterien
 Lichtquelle: 3W COB LED
 Lichtstrom: 200LM*
 Konstante Betriebszeit: 3 Std.
 Beleuchtungsmodi: AN/AUS
 Abmessungen: 91 x 35 x 128mm

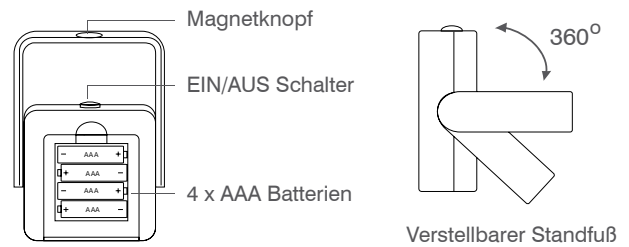

Spezifikationen							
Modell	LEDs	LED Typ	Lumen	Batteriemodell	Material	erhältliche Farben	Wasser-resistent (Y/N)
S31	1	3W COB LED	200lm	4 x AAA	Plastic	■ Schwarz	N

Verpackungsdetails														
Artikel	Verpackungstyp	beinhaltete Batterien	Blister/Boxdetails					Verpackungseinheiten	Umkartondetails					
			Abmaße (mm)			Nettogewicht (g)	Abmaße (cm)			Volumen (cbm)	Bruttogewicht (Kg)	Nettogewicht (kg)		
			L Länge	B Breite	T Tiefe		L Länge		B Breite				T Tiefe	
S31-4LR03D12	Display Box	4 x LR03	320	170	132	2046	48	36	34	29	0.0355	8.18	8.58	

2-IN-1 Spotlight



Eigenschaften

- 3W Hochleistungs-LED und Duo-Farb-COB
- 2-in-1-Multifunktionslampe
- Fünf verschiedene Beleuchtungsmodi (niedriger Lichtstrahl/ hoher Lichtstrahl/weißes Licht / rotes Licht / rot blinken)
- Seitlicher Handgriff mit zwei Positionen mit einem faltbaren Griff

Spezifikationen

Stromquelle: 3 x AA Batterien
 Lichtquelle: 3W weiße LED + 3W Duo Farbe COB
 LED Beleuchtungsmodi:
 niedriger Lichtstrahl / hoher Lichtstrahl
 COB Beleuchtungsmodi:
 Weißes Licht/ Rotes Licht/ Rotes Blinken
 LED Lichtstrom hoch: 230 Lumen niedrig: 160 Lumen
 COB Lichtstrom weiß: 150 Lumen
 LED Dauerbetriebszeit hoch: 4 Std., Niedrig: 6 Std.
 COB Dauerbetriebszeit weiß: 6 Std.

5 Beleuchtungsmodi

LED Handscheinwerfermodi



COB Laternenmodi



S32-3R6PCB



Spezifikationen

Modell	LEDs	LED Typ	Lumen	Batteriemodell	Material	erhältliche Farben	Wasser-resistent (Y/N)
S32	1	3W COB LED	230lm	3 x AA	Plastic	■ Schwarz	N

Verpackungsdetails

Artikel	Verpackungstyp	beinhaltete Batterien	Blister/Boxdetails				Umkartondetails						
			Abmaße (mm)			Nettogewicht (g)	Verpackungseinheiten	Abmaße (cm)			Volumen (cbm)	Bruttogewicht (Kg)	Nettogewicht (kg)
			L Länge	B Breite	T Tiefe			L Länge	B Breite	T Tiefe			
S32-3R6PCB	Color Box	3 x R6P	185	105	148	350	6	38.5	33	16.8	0.0214	2.6	2.35

Profi Werkstattleuchten



Geeignet für: Profis, Camping, Outdoor, Höhlenforschung

S20

Eigenschaften

- Leistungsstarke 8W COB LED-Beleuchtung
- 2 Beleuchtungsmodi: hoher Lichtstrahl / niedriger Lichtstrahl
- 360° drehbarer Standfuß, kann in jede Richtung eingestellt werden, bequem zu tragen oder auf den Tisch stellen
- Lange COB Lebensdauer, muss nicht ersetzt werden, extrem energiesparend

Spezifikationen

- Stromquelle: Li-ion 18650, 3,7V, 4000mAh
- Lichtquelle: 8W COB LED
- Lichtstrom hoch: 500 Lumen niedrig: 300 Lumen
- Kontinuierliche Betriebszeit: hoch 2 Std. Niedrig 5 Std.
- Abmessungen: 225 x 195 x 58mm
- Zubehör: USB Ladekabel L = 1,2m

S21

Eigenschaften

- Wiederaufladbar - betrieben mit einem eingebauten 2200mAh Li-ion Akkupack
- Portabel und leichtgewichtig - ausgestattet mit einem Griff und ein abnehmbarer Standfuß, leicht zu tragen, zum aufstellen oder aufhängen
- Wetterfest - hervorragend für Außer Haus Anwendung, 360° drehbar
- Verstellbarer Griff und Standfuß - 360° drehbar, kann leicht nach Ihren Anforderungen angepasst werden

Spezifikationen

- Stromquelle: Li-ion 18650, 7,4V, 2200mAh
- Lichtquelle: 10W COB
- Eingang: DC 8,4V, 1A max.
- Ladezeit: ca. 3 Std.
- Farbtemperatur: 6000K - 6500K
- Lichtstrom: 800 Lumen
- Lichtstrahlwinkel: 120°
- Betriebszeit: 4 Std.
- Schutzklasse: IP65
- Abmessungen: 123 x 132 x 250mm
- Zubehör: AC Adapter und KFZ Ladegerät

S22

Eigenschaften

- Wiederaufladbar - betrieben mit einem eingebauten 4400mAh Li-ion Akkupack
- Portabel und leichtgewichtig - ausgestattet mit einem Griff und ein abnehmbarer Standfuß, leicht zu tragen, zum aufstellen oder aufhängen
- Wetterfest - hervorragend für Außer Haus Anwendung, 360° drehbar
- Verstellbarer Griff und Standfuß - 360° drehbar, kann leicht nach Ihren Anforderungen angepasst werden

Spezifikationen

- Stromquelle: Li-ion 18650, 7,4V, 4400mAh
- Lichtquelle: 20W COB
- Eingang: DC 8,4V, 1A max.
- Ladezeit: ca. 6 Std.
- Farbtemperatur: 6000K - 6500K
- Lichtstrom: 1600 Lumen
- Lichtstrahlwinkel: 120°
- Betriebszeit: 4 Std.
- Schutzklasse: IP65
- Abmessungen: 163 x 163 x 300mm
- Zubehör: AC Adapter und KFZ Ladegerät

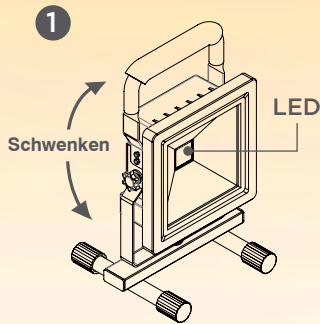

S22



S22-CB



4 260216 456794

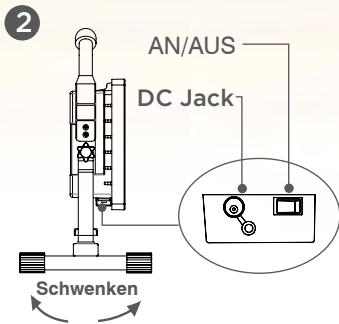

S21



S21-CB



4 260216 456787

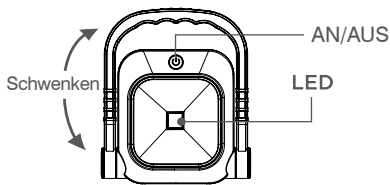

S20



S20-CB



4 260216 456800

Spezifikationen

Modell	LED Typ	Lumem	Batteriemodell	Body Material	erhältliche Farben	Wasser-resistent (Y/N)
S20	8W COB LED	500lm	Li-ion 18650	Plastic	Schwarz	N
S21	10W COB LED	800lm	Li-ion 18650	Plastic	Gelb	Y
S22	20W COB LED	1600lm	Li-ion 18650	Plastic	Rot	Y

Verpackungsdetails

Artikel	Verpackungstyp	beinhaltete Batterien	Blister/Boxdetails					Umkartondetails						
			Abmaße (mm)			Nettogewicht (g)	Verpackungseinheiten	Abmaße (cm)			Volumen (cbm)	Bruttogewicht (Kg)	Nettogewicht (kg)	
			L Länge	B Breite	T Tiefe			L Länge	B Breite	T Tiefe				
S20-CB	Color Box	Li-ion 18650	205	75	240	600	12	47	42.5	26	0.0519	7.7	7.2	
S21-CB	Color Box	Li-ion 18650	130	110	225	1100	12	45.5	40.5	24.5	0.0451	14.2	13.2	
S22-CB	Color Box	Li-ion 18650	170	120	270	1600	10	61.5	35.5	29	0.0633	17	16	

Haushaltsleuchte

Ideal für den Haushalt

SL7018

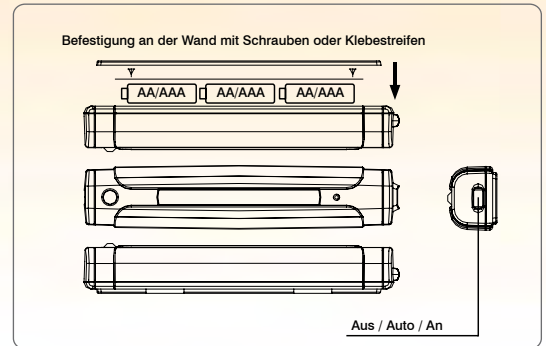

Sensorleuchte

- Breiter Sensorwinkel
- Lange Sensordistanz
- Wahl der Montage durch Klebeband oder Schrauben
- Abnehmbarer Körper von der montierten Basis

Bestens für:

Schlafzimmer, Flur, Treppenhaus, Badezimmer



SL7018-3R6TB



Spezifikationen

Modell	Bulb Typ	Lumen	Batteriemodell	Material	erhältliche Farben	Wasser-resistent (Y/N)
SL7018	Super Bright LED	15lm	3 x AA	Kunststoff	<input type="checkbox"/> weiß	N

Verpackungsdetails

Artikel	Verpackungstyp	beinhaltete Batterien	Blister/Boxdetails				Verpackungseinheiten	Umkartondetails					
			Abmaße (mm)			Nettogewicht (g)		Abmaße (cm)			Volumen (cbm)	Bruttogewicht (Kg)	Nettogewicht (kg)
			L Länge	B Breite	T Tiefe			L Länge	B Breite	T Tiefe			
SL7018-3R6TB	Blister Pack	3 x R6P	190	110	48	139	48	52.5	44.5	21.5	0.0502	7.9	6.7

Ersatzlampen für Taschenlampen

LED Ersatzlampen

Lebensdauer bis zu **10.000** Stunden.

Energiesparende LED Ersatzlampen

3V
2x Batterien
4.5V
3x Batterien
6V
4x Batterien



3V

4.5V

6V

Spezifikation

Model No.	Lampentyp	Spannung	Ampere	Watt	Lumen	Farbtemperatur in Kelvin	Socket	durchschnittliche Lebensdauer	Batteriesorte
BL304 WN	LED Taschenlampenbirne	3 V	0,13	0.4W	30	6000--8000 (Tageslicht)	P 13.5S	10,000	2x(AA/AAA/D/C)
BL406 WN	LED Taschenlampenbirne	4.5 V	0,13	0.6W	38	6000--8000 (Tageslicht)	P 13.5S	10,000	3x(AA/AAA/D/C 3LR12,3R12)
BL608 WN	LED Taschenlampenbirne	6 V	0,13	0.8W	42	6000--8000 (Tageslicht)	P 13.5S	10,000	4x(AA/AAA/D/C), 4R25

Verpackungsabbildung	Name	Artikel	Verpackungstyp	Verpackungsdetails										
				Blister/Boxdetails				Umkartondetails						
				Abmaße (mm)			Nettogewicht (g)	Verpackungseinheiten	Abmaße (cm)			Volumen (cbm)	Bruttogewicht (Kg)	Nettogewicht (kg)
				L Länge	B Breite	T Tiefe			L Länge	B Breite	T Tiefe			
	LED Ersatzbirnen	BL304WN-BP1	Blister Pack	92	55	14	6	480	30.5	30	24.8	0.0227	4.4	2.4
		BL406WN-BP1		92	55	14	6	480	30.5	30	24.8	0.0227	4.4	2.4
		BL608WN-BP1		92	55	14	6	480	30.5	30	24.8	0.0227	4.4	2.4

Promotionartikel



Promotionartikel

Maximale Wirkung, Minimaler Platz, Optimaler Umsatz

Wenn Sie möchten, dass Ihre Camelion Produkte eine maximale Wirkung haben, brauchen Sie optimales Verkaufszubehör.

Für die neuesten Verkaufsaccessoires kontaktieren Sie uns unter info@camelion.com



WCD-02



WCD-03



WCD-05

Metall Thekendisplay

WCD-02: 33x43x22cm (6 Haken)

WCD-03: 33x58x22cm (9 Haken)

WCD-05: 44x66x20cm (12 Haken)

- Robuste Stahlkonstruktion
- Einfach aufzustellen und zu bestücken
- Idealer Eye Catcher mit wenig Platzbedarf
- Erhältlich in Metall schwarz



WCD-06

Metall Bodendisplay

- 10 Racks mit jeweils 2 Haken (B=15cm)
- Einfache und leichtgewichtige Konstruktion
- B x H x T: 30x158x35 cm

Menge pro Haken:

AAA Größe: 10 Packs

AA Größe: 7 Packs

9V Größe: 6 Packs

C Größe: 5 Packs

D Größe: 4 Packs



Metall Thekendisplay

MFD-02

- Robuste Lochwand aus gebürstetem Stahl
- 16 Haken sind im Lieferumfang enthalten
- Leichter Aufbau (ohne schrauben oder hämmern)
- Inklusive Aufbauanleitung
- Professionelles Design
- B x H x T: 46x70x26cm (16 Haken Aufsteller)



Metall Bodendisplay

MFD-03

- Robuste Lochwand aus gebürstetem Stahl
- 36 Haken sind im Lieferumfang enthalten
- Leichter Aufbau (ohne schrauben oder hämmern)
- Inklusive Aufbauanleitung
- Professionelles Design
- B x H x T: 80x180x61 cm



Metall Bodendisplay

MFD-06

Robuste Stahlkonstruktion für eine lange Lebensdauer

Bei diesem Display präsentieren Sie Ihre Camelion Produkte ansprechend und klar.

Das leicht geschwungene Bodendisplay fokussiert die Aufmerksamkeit direkt auf das Produktsortiment und darüber hinaus betont es die Marke Camelion - ein wichtiger Impuls für eine positive Kaufentscheidung.

B x H x T: 107 x 177 x 33cm

Display Box



DR16 Promotion Display "8+4 free"

- Plus Alkaline Bodendisplay für Promotion Blister "8+4 free" (AA / AAA)
- Höhe (gesamt) 1,17m + Palette
- Breite 0,55m
- Tiefe 0,38m
- Material Pappe
- Oberfläche glänzend
- 12x Gitter = 12 Ablagefächer
- 48x LR6 "8+4 free" (8 Ablagefächer)
6 Blister per Ablagefach
- 36 x LR03 "8+4 free" (4 Ablagefächer)
9 Blister per Ablagefach
- 84 Blister gesamt



Plus Alkaline LR6 BP8+4
Art. Nr. 110 84006
EAN 4260216453915
Umkarton 48 / VE 6



Plus Alkaline LR03 BP8+4
Art. Nr. 110 84003
EAN 4260216453922
Umkarton 48 / VE 6



DR16 Promotion Display "24"

- Plus Alkaline Bodendisplay für Plastik Box "24" (AA / AAA)
- Höhe (gesamt) 1,17m + Palette
- Breite 0,55m
- Tiefe 0,38m
- Material Pappe
- Oberfläche glänzend
- 32x Gitter = 32 Ablagefächer
- 60 x LR6 "24" (20 Ablagefächer)
3 Boxen per Ablagefach
- 48 x LR03 "24" (12 Ablagefächer)
4 Boxen per Ablagefach
- 108 Boxen gesamt



Plus Alkaline LR6 PB24
Art. Nr. 111 02406
EAN 4260033150455
Umkarton 30 / VE 6



Plus Alkaline LR03 PB24
Art. Nr. 111 02403
EAN 4260033150462
Umkarton 30 / VE 6



Acryl Thekendisplay

ADS-01

- Kompakte Größe, geeignet für die Theke oder in der Nähe der Kasse
- 15 flexible Haken für verschiedene Produktserien (Haken: L = 5 cm)
- Abmaße: (B x H x T mm): 345x 480x135 (75°)
- Elegantes Design: Ökonomisch und vielseitig einsetzbar
- Langlebig und leicht: aus Acryl

Sechs Möglichkeiten:





DR-11

DR-12

Batterie Bodendisplay

- Bodendisplay in Batterieform sorgt für eine hohe Markenwiedererkennung
- Maximale Markenaufmerksamkeit durch prägnante Grafik
- Stabiles Material ermöglicht einen einfachen Transport
- Ideal für den Einzelhandel und Messen

DR11: B x H x T: 60 x 158 x 31 cm
DR12: B x H x T: 42 x 70,5 x 21 cm



SPK-01

SPK-02

AlwaysReady und Digi Alkaline Lautsprecher

Die AlwaysReady und Digi Alkaline Lautsprecher liefern beeindruckende Lautstärke und Klarheit, sie sind klein genug, um sie in die Hosentasche stecken zu können und verwenden einen Standard-Kopfhöreranschluss für die Verbindung zu Ihrem Musik-Gerät, ideal um mühelos Ihre Lieblingsmusik über jedes iPhone, iPod, MP3 / 4 Player, Smartphone oder Laptop zu verstärken.



Kugelschreiber

PN-04R



Kugelschreiber

PN-04B



Papier Tasche

PB-01

- Material: Papier
- B x H x T: 54x14x44,5cm



Kunstfasergewebte Tasche

HB-04

- Material: fiber
- B x H x T: 38x34x10cm



Caps

C-01

Bequeme Golf-Cappies für alle Größen einstellbar in modischen Farben

Camelion Katalog 2018 Register

Seite	Produkt	Art.Nr.	EAN Code	Seite	Produkt	Art.Nr.	EAN Code	Seite	Produkt	Art.Nr.	EAN Code
LITHIUM P7 / 9V LITHIUM BATTERIEN				14	R14P-BP2B	102 00214	4260033151025	19	CR2477-BP1	130 01477	4260216455353
6	FR6-BP2	190 00206	4260033154859	14	R6P-BP4B	102 00406	4260033151049	19	CR927-BP1	130 01927	4260216452475
6	FR03-BP2	190 00203	4260033154873	14	R03P-BP4B	102 00403	4260033151070	19	CR1216-BP5	130 05216	4260033152718
6	ER9-BP1	190 00122	4260216450334	14	R6P-HP12B	102 01206	4260033151438	19	CR1220-BP5	130 05122	4260033152701
6	ER9-SP1	191 00122	4260216455599	14	6F22-BP1B	102 00122	4260033151094	19	CR1225-BP5	130 05225	4260033152695
DIGI ALKALINE / BLISTER				14	R6P-HP12B	102 01206	4260033151438	19	CR1616-BP5	130 05161	4260033152688
7	LR20-BP2DG	112 10220	4260216453885	14	4R25-SP1B	101 10125	4260033153531	19	CR1620-BP5	130 05620	4260033152671
7	LR14-BP2DG	112 10214	4260216453892	SUPER HEAVY DUTY GRÜN				19	CR1632-BP5	130 05632	4260216455797
7	LR6-BP4DG	112 10406	4260033154521	15	R20-BP2G	100 00220	4260033156280	19	CR2016-BP5	130 05016	4260033152664
7	LR6-BP2DG	112 10206	4260033154538	15	R20-BP4G	100 00420	4260033156358	19	CR2025-BP5	130 05025	4260033152657
7	LR03-BP4DG	112 10403	4260033154545	15	R14-BP2G	100 00214	4260033156297	19	CR2032-BP5	130 05032	4260033152640
7	LR03-BP2DG	112 10203	4260033154552	15	R14-BP4G	100 00414	4260033156389	19	CR2430-BP5	130 05430	4260216455803
7	6LR61-BP1DG	112 10122	4260216454028	15	R14-BP6G	100 00614	4260033150936	19	CR2450-BP5	130 05450	4260216455810
PLUS ALKALINE				15	R6-BP8G	100 00806	4260033156402	19	CRVPO1-BP6	130 00600	4260216456145
8	LR20-BP2	110 00220	4260033150004	15	R6-BP4G	100 00406	4260033156303	Alkaline Knopfzellen			
8	LR14-BP2	110 00214	4260033150011	15	R6-BP10G	100 01006	4260033156396	20	AG1-BP2 (0%HG)	120 50201	4260216454783
8	LR6-BP4	110 00406	4260033150028	15	R03-BP4G	100 00403	4260033156327	20	AG2-BP2 (0%HG)	120 50202	4260216454790
8	LR6-BP2	110 00206	4260033150035	15	R03-BP8G	100 00803	4260033156426	20	AG3-BP2 (0%HG)	120 50203	4260216454806
8	4+4LR6	110 44806	4260216451096	16	6F22-BP1G	100 00122	4260033156341	20	AG4-BP2 (0%HG)	120 50204	4260216454622
8	LR6-HP12	110 01206	4260033150424	16	6F22-BP2G	100 00222	4260033156365	20	AG5-BP2 (0%HG)	120 50205	4260216454813
8	LR6-BP10	110 01006	4260033150097	16	3R12-BP1G	100 00112	4260033156372	20	AG6-BP2 (0%HG)	120 50206	4260216454820
8	LR03-BP2	110 00203	4260033150059	16	2R10-BP1G	100 00110	4260033150943	20	AG7-BP2 (0%HG)	120 50207	4260216454837
9	LR03-BP4	110 00403	4260033150042	16	R20-SP2G	101 00220	4260033156433	20	AG8-BP2 (0%HG)	120 50208	4260216454844
9	4+4LR03	110 44803	4260216451102	16	R14-SP2G	101 00214	4260033156440	20	AG9-BP2 (0%HG)	120 50209	4260216454851
9	LR03-BP10	110 01003	4260033150103	16	R6-SP2G	101 00206	4260033156464	20	AG10-BP2 (0%HG)	120 50210	4260216454608
9	6LR61-BP1	110 00122	4260033150066	16	R6-SP4G	101 00406	4260033156457	20	AG11-BP2 (0%HG)	120 50211	4260216454868
9	LR1-BP2	110 00201	4260033150080	16	R03-SP2G	101 00203	4260033156488	20	AG12-BP2 (0%HG)	120 50212	4260216454875
9	LR1-BP5	110 00501	4260216455780	16	R03-SP4G	101 00403	4260033156471	20	AG13-BP2 (0%HG)	120 50213	4260216454615
9	LR61-BP2	110 00261	4260033150295	17	6F22-SP1G	101 00122	4260033156495	20	625A-BP1 (0%HG)	120 50125	4260216454882
9	3LR12-BP1	110 00112	4260033150073	17	4R25-SP1G	10100125	4260033156211	20	AG0-BP10 (0%HG)	120 51000	4260216454899
9	LR6 bulk	110 90006	-	17	3R12-SP1G	10100112	4260033156501	20	AG1-BP10 (0%HG)	120 51001	4260216454905
9	LR03 bulk	110 90003	-	17	FPG-GB40	101 04000	4260033150905	20	AG2-BP10 (0%HG)	120 51002	4260216454912
10	LR6-SP40HFB	111 04006	4260216456428	17	4+2R6PG-BP	100 42606	4260216456138	20	AG3-BP10 (0%HG)	120 51003	4260216454929
10	LR03-SP40HFB	111 04003	4260216456435	17	4+2R03PG-BP	100 42603	4260216456121	20	AG4-BP10 (0%HG)	120 51004	4260216454400
10	LR6-SP2	111 00206	4260033150332	17	R6-SP8G	101 08006	4260216451118	20	AG5-BP10 (0%HG)	120 51005	4260216454936
10	LR6-SP4	111 00406	4260033150325	17	R03-SP8G	101 08003	4260216451188	20	AG6-BP10 (0%HG)	120 51006	4260216454943
10	LR03-SP2	111 00203	4260033150356	18	R6-SP12G	101 01206	4260033156266	20	AG7-BP10 (0%HG)	120 51007	4260216454950
10	LR03-SP4	111 00403	4260033150349	18	R03-SP12G	101 01203	4260216451199	20	AG8-BP10 (0%HG)	120 51008	4260216454967
10	LR14-SP2	111 00214	4260033150318	FOTO LITHIUM BATTERIEN				20	AG9-BP10 (0%HG)	120 51009	4260216454974
10	LR20-SP2	111 00220	4260033150301	18	CR123A-BP1	190 01123	4260033153364	20	AG10-BP10 (0%HG)	120 51010	4260216454981
10	6LR61-SP1	111 00122	4260033150363	18	CR123A-BP2	190 02123	4260216456688	20	AG11-BP10 (0%HG)	120 51011	4260216454998
10	3LR12-SP1	111 00112	4260033150370	18	2CR5-BP1	190 01125	4260033153395	20	AG12-BP10 (0%HG)	120 51012	4260216455001
11	LR6-PB24	111 02406	4260033150455	18	CR-P2-BP1	190 01152	4260033153371	20	AG13-BP10 (0%HG)	120 51013	4260216455018
11	LR03-PB24	111 02403	4260033150462	18	CR2-BP1	190 01142	4260033153388	21	A11-BP1 (0%HG)	110 50111	4260216455049
11	LR6-PB20	111 02006	4260216453106	Lithium Knopfzellen				21	A23-BP1 (0%HG)	110 50123	4260216455056
11	LR03-PB20	111 02003	4260216453113	19	CR1216-BP1	130 01216	4260033152831	21	A27-BP1 (0%HG)	110 50127	4260216455063
11	6LR61-PB6	111 00622	4260033150479	19	CR1220-BP1	130 01122	4260033152824	21	A32-BP1 (0%HG)	110 50132	4260216455070
11	LR6-PBH24	111 12406	4260033155092	19	CR1225-BP1	130 01225	4260033152817	21	A23-BP5 (0%HG)	110 50523	4260216455087
11	LR03-PBH24	111 12403	4260033155108	19	CR1616-BP1	130 01161	4260033152800	21	A27-BP5 (0%HG)	110 50527	4260216455094
11	CM-FA-01	111 00029	4260033155160	19	CR1620-BP1	130 01620	4260033152794	21	4LR44-BP1 (0%HG)	120 50144	4260216455025
12	LR6-SP10-DA	111 01006	4260033157249	19	CR1632-BP1	130 01632	4260033152923	21	4LR44-BP5 (0%HG)	120 50544	4260216455827
12	LR03-SP10-DA	111 01003	4260033157256	19	CR2016-BP1	130 01016	4260033152787	21	4LR43-BP1 (0%HG)	120 00143	4260216455025
LIMITED EDITION				19	CR2025-BP1	130 01025	4260033152770	ZINK-LUFT KNOPFZELLEN			
12	10+2-LR6-DA	111 01206	4260216456443	19	CR2032-BP1	130 01032	4260033152763	22	A13-BP6 (0%HG)	150 56013	4260030253975
12	10+2-LR03-DA	111 01203	4260216456550	19	CR2320-BP1	130 01320	4260033152756	22	A10-BP6 (0%HG)	150 56010	4260030253968
13	8+4LR6-BP	110 84006	4260216453915	19	CR2330-BP1	130 01330	4260033152749	22	A675-BP6 (0%HG)	150 56675	4260030253999
13	8+4LR03-BP	110 84003	4260216453922	19	CR2325-BP1	130 01325	4260033152848	22	A312-BP6 (0%HG)	150 56312	4260030253982
SUPER HEAVY DUTY BLAU				19	CR2430-BP1	130 01430	4260033152732				
14	R20P-BP2B	102 00220	4260033151018	19	CR2450-BP1	130 01450	4260033152725				

Seite	Produkt	Art.Nr.	EAN Code
SILBER OXIDE KNOPFZELLEN			
22	SR41-BP1 (0%HG)	140 51041	4260216455117
22	SR43-BP1 (0%HG)	140 51043	4260216455124
22	SR44-BP1 (0%HG)	140 51044	4260216455131
22	SR54-BP1 (0%HG)	140 51054	4260216455148
22	SR57-BP1 (0%HG)	140 51057	4260216455155
22	SR58-BP1 (0%HG)	140 51058	4260216455162
22	SR59-BP1 (0%HG)	140 51059	4260216455179
22	SR60-BP1 (0%HG)	140 51060	4260216455186
22	SR63-BP1 (0%HG)	140 51063	4260216455193
22	SR66-BP1 (0%HG)	140 51066	4260216455209
22	SR69-BP1 (0%HG)	140 51069	4260216455216
22	SR41-BP5 (0%HG)	140 55041	4260216455223
22	SR43-BP5 (0%HG)	140 55043	4260216455230
22	SR44-BP5 (0%HG)	140 55044	4260216455247
22	SR54-BP5 (0%HG)	140 55054	4260216455254
22	SR57-BP5 (0%HG)	140 55057	4260216455261
22	SR58-BP5 (0%HG)	140 55058	4260216455278
22	SR59-BP5 (0%HG)	140 55059	4260216455285
22	SR60-BP5 (0%HG)	140 55060	4260216455292
22	SR63-BP5 (0%HG)	140 55063	4260216455308
22	SR66-BP5 (0%HG)	140 55066	4260216455315
22	SR69-BP5 (0%HG)	140 55069	4260216455322
22	4SR44-BP1 (0%HG)	140 51444	4260216455032
22	4SR44-Bulk (0%HG)	140 52444	-
BATTERIE ADAPTER & AUFBEWAHRUNGSBOXEN			
23	Aufbewahrungsbox für 4 x AAA / AA Batterien & Akkus	500 00001	4260033157539
23	Aufbewahrungsbox für 4 x AAA / AA Batterien & Akkus	500 00002	4260033157539
23	Plastik Box für 24x AA PB24	501 00017	
23	Plastik Box für 24x AAA PB2	501 00018	
23	Adapter aus Plastik für C (Farbe: weiß)	999 00014	4260033157546
23	Adapter aus Plastik für D (Farbe: weiß)	999 00020	4260033157553
23	Adapter aus Aluminium für C	999 10014	4260033156518
23	Adapter aus Aluminium für D	999 10020	4260033156525
Batterie TESTER			
23	BT-503	203 00503	4260033157508
"ALWAYS READY" AKKU			
26	NH-AA2500ARBP2	174 25206	4260216453038
26	NH-9V200ARBP1	174 20122	4260033155221
26	NH-AA2300ARBP2	174 23206	4260033152336
26	NH-AA2300ARBP4	174 23406	4260033154040
26	NH-AAA800ARBP2	174 08203	4260033152305
26	NH-AAA800ARBP4	174 08403	4260033152312
27	NH-AA800ARBP2	174 08206	4260216453236
27	NH-AA600ARBP4(GSL)	174 06406	4260216455667
27	NH-AAA600ARBP4(GSL)	174 06403	4260216455674
NI-MH AKKU			
28	NH-D10000BP2	170 10220	4260033151865
28	NH-D7000BP2	170 70220	4260033151520
28	NH-D2500BP2	170 25220	4260033151537
28	NH-C3500BP2	170 35214	4260033151544
28	NH-C2500BP2	170 25214	4260033151551
28	NH-AA2700BP4	170 27406	4260033151933
28	NH-AA2700BP2	170 27206	4260033151926
29	NH-AA2500BP4	170 25406	4260033151834

Seite	Produkt	Art.Nr.	EAN Code
29	NH-AA2500BP2	170 25206	4260033151827
29	NH-AA2300BP4	170 23406	4260033151742
29	NH-AA2300BP2	170 23206	4260033151735
29	NH-AA2000BP2	170 20206	4260033151582
29	NH-AA1800BP4	170 18406	4260033151612
29	NH-AA1800BP2	170 18206	4260033151605
29	NH-AA1500BP2	170 15206	4260033151629
30	NH-AAA1100BP4	170 11403	4260033151957
30	NH-AAA1100BP2	170 11203	4260033151940
30	NH-AAA1000BP4	170 10403	4260033151889
30	NH-AAA1000BP2	170 10203	4260033151872
30	NH-AAA900BP4	170 09403	4260033151766
30	NH-AAA900BP2	170 09203	4260033151759
30	NH-AAA800BP2	170 08203	4260033151667
31	NH-AAA600BP4	170 06403	4260033151711
31	NH-AAA600BP2	170 06203	4260033151704
31	NH-9V250BP1	170 25122	4260033151810
31	NH-9V200BP1	170 20122	4260033151728
LITHIUM-ION AKKU			
31	ICR18650F-26bulk	17802600	
31	ICR18650F-22bulk	17802200	
ULTRA SCHNELL LADEGERÄT			
33	BC-0907	200 00907	4260033157706
33	BC-0907-UK Plug	200 01907	4260216456640
SUPER SCHNELL LADEGERÄT			
34	BC-0905A with UK Plug	200 01905	4260033157812
SCHNELL LADEGERÄT			
35	BC-1010B	20101010	4260216456473
36	BC-1002A mit UK Stecker	201 01002	4260216456497
37	BC-1012	201 01012	4260216453199
STECKER LADEGERÄT			
38	BC-1001A	200 01001	4260033158260
38	BC-1001A mit UK Stecker	201 01001	4260216456480
39	BC-0904S	200 00904	4260033157850
40	BC-0901	20000901	4260033157867
UNIVERSAL LADEGERÄT			
41	CM-9398	200 09398	4260030259403
42	CM-3298	200 03298	4260030255900
43	CM-9388	200 09388	4260033158512
44	LBC-312	200 00312	4260216452994
45	LBC-313-1	20003131	4260216456756
LITHIUM-ION LADEGERÄT			
46	LBC-305	20000305	4260216456763
PROFI LADEGERÄT			
47	CM-500	200 00500	4260030255917
POWERBANKS			
51	PS675	20200675	4260216456282
51	PS679	20200679	4260216456817
USB STECKERADAPTER			
52	AD568-DB	200 00568	4260216455476
52	AD569-DB	200 00569	4260216454769
USB KFZ LADEADAPTER			
53	DD801	202 00801	4260216452550
53	DD802	202 00802	4260216450563
54	DD823	20200823	4260216456343
USB LADER-SORTIMENT			
54	3 in 1 USB Charger Set	200 00123	4260216456411

Seite	Produkt	Art.Nr.	EAN Code
LED TASCHENLAMPEN			
57	FL6L2D2R20P	302 00040	4260216452796
58	FL1L2DR20P	302 00026	4260033155542
58	FL1L2DD12	302 00043	4260033155610
58	FL1L2CB2R14P	302 00045	4260216454677
58	FL1L2AA2R6P	302 00025	4260033155566
58	FL1L2AAD24	302 00044	4260033155603
60	FL-16LED	302 00033	4260033155504
60	FL-9LED	302 00034	4260033155481
60	CM25L	30200054	4260216456770
62	SL3013 LED Schlüsselanhänger	302 00047	4260216456084
62	SL3013 LED Schlüsselanhänger im Fischglas mit 36 Stück	302 00046	4260216454059
64	HP7011-3R03PBP	302 00028	4260216450136
64	PT1L2D-2R6PBP	302 00053	4260216456381
64	PT1L2AA-2R6PBP	302 00052	4260216456374
66	DL2AAAS Aluminium Stilleuchte	300 00017	4260033154347
67	T11-3R03PD12	302 00051	4260216456244
LED TASCHENLAMPEN CT-SERIE			
68	CT4004	302 00011	4260030255733
68	CT4005	302 00008	4260030255740
68	CT4010	30200027	4260030255795
70	36 x LED SOLAR Laterne	302 00012	4260030255474
70	CT4008	302 00024	4260030255771
70	CT4007	302 00023	4260030255764
COB LED WERKSTATTLEUCHE			
72	SL5240N-3R6PD12	302 00049	4260216456152
72	SL7280N-3R03PD12	302 00048	4260216456169
74	S31-D12	30200056	4260216456534
75	S32 2in1 Spotlight	30200055	4260216456718
76	S20 10W COB LED Werkstattleuchte	30200057	4260216456800
76	S21 10W COB LED Strahler	30200058	4260216456787
76	S22 20W COB LED Strahler	30200059	4260216456794
78	SL7018-3R6TB	302 00050	4260216456312
LED ERSATZBIRNEN FÜR TASCHENLAMPEN			
79	BL304WN		
79	BL406WN		
79	BL608WN		
BATTERIE AUFSTELLER (BODEN DISPLAYS / THEKEN DISPLAYS / STRIPS)			
81	WCD-02 Theken Display 6-Haken	501 00006	-
81	WCD-03 Theken Display 9-Haken	501 00007	-
81	WCD-06 Bodenaufsteller 20-Haken	501 00015	-
81	MFD-02 Theken Display 16-Haken	501 00003	-
81	MFD-03 Bodenaufsteller 36 Haken	501 00001	-
81	MFD-06 Bodenaufsteller 80 Haken	501 00021	-
82	DR-16 8+4 Free	50100029	
82	DR-16 24	50100028	
82	ADS-01 Acryl Theken Display 15-Haken	501 00019	-
83	DR-11 Batterie Bodenaufsteller 28 Haken H x B = 160 x 65cm	501 00020	-
83	DR-12 Batterie Bodenaufsteller 9 Haken H x B = 70 x 32cm	501 00025	-
83	diverse Promotionalartikel	501 00004	-

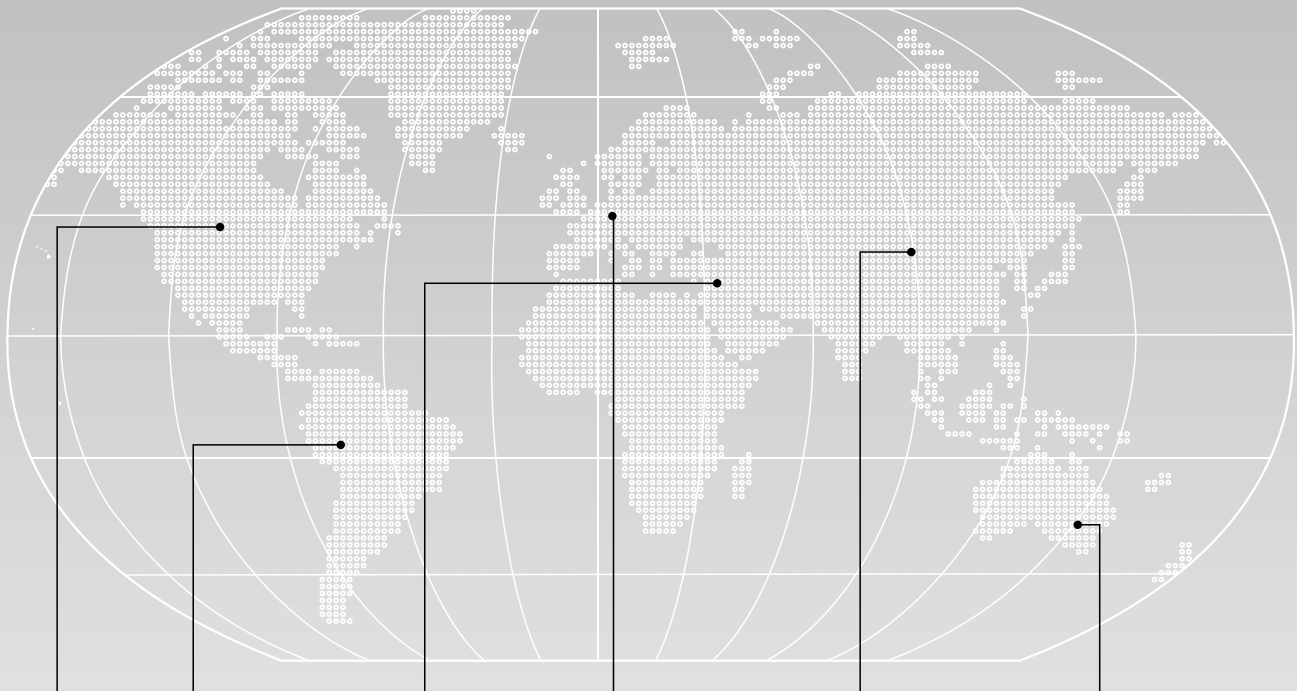

Nordamerika

- Canada
- U. S. A

Karibik / Lateinamerika

- Argentina
- Brazil
- Bolivia
- Chile
- Colombia
- Costa Rica
- Cuba
- Dominica
- Ecuador
- EL Salvador
- Guatemala
- Haiti
- Mexico
- Nicaragua
- Panama
- Paraguay
- Peru
- Puerto Rico
- Trinidad and Tobago
- Uruguay
- Venezuela

Mittlerer Osten / Afrika

- Algeria
- Benin
- Egypt
- Iran
- Israel
- Kuwait
- Lebanon
- Sierra Leone
- Saudi Arabia
- Syria
- S. Africa
- Tunisia
- U.A.E.
- Uganda

Europa

- Austria
- Albania
- Andorra
- Belarus
- Belgium
- Bosnia
- Bulgaria
- Czech Republic
- Croatia
- Cyprus
- Denmark
- Estonia
- Finland
- France
- Germany
- Georgia
- Greece
- Hungary
- Iceland
- Ireland
- Italy
- Latvia
- Lithuania
- Luxembourg
- Macedonia
- Malta
- Netherland
- Norway
- Portugal
- Poland
- Romania
- Russia
- Serbia
- Slovakia
- Slovenia
- Spain
- Sweden
- Switzerland
- Turkey
- United Kingdom
- Ukraine

Asien

- Afghanistan
- Armenia
- Azerbaijan
- Bangladesh
- Cambodia
- China
- Hong Kong
- Indonesia
- India
- Iraq
- Japan
- Jordan
- Korea
- Kazakhstan
- Lao
- Malaysia
- Pakistan
- Philippines
- Singapore
- Sri Lanka
- Taiwan
- Thailand
- Turkmenistan
- Vietnam
- Yemen

Ozeanien

- Australia
- Fiji
- New Zealand

Europa Zentrale & Lager

Camelion Batterien GmbH
 Bergiusstr. 53-59, D-12057 Berlin
 GERMANY



 Camelion Batterien GmbH



Für mehr Informationen besuchen Sie www.camelion.com

Copyright ©2018 Batterien GmbH, All rights reserved